

GME
DIVISION BAÑOS



2023

**BOX DOCCIA STD
E SU MISURA**

Pronta consegna · 100% Stock

ALLUMINIO • ACCIAIO • PIEGHEVOLI • FISSI • A BATTENTE • SU MISURA • VASCA

CERTIFICAZIONI DI QUALITÀ



Allo stesso tempo, GME DIVISIÓN BAÑOS SL è associata all'istituto tecnologico AIDIMME, dove si effettuano ispezioni e test di laboratorio per garantire la qualità e il corretto funzionamento dei prodotti offerti.

Preoccupata della qualità che offriamo ai nostri clienti, GME DIVISIÓN BAÑOS SL dispone di certificati che garantiscono la qualità di tutti i suoi prodotti, conformi a tutte le normative europee.



I livelli di qualità dei nostri prodotti ci consentono di estendere la garanzia prevista dalla legge a 3 anni. Questa garanzia non copre le parti in plastica o i cuscinetti e decade in caso di uso improprio o di manipolazione dei prodotti.

GME

DIVISION BAÑOS



PRESENZA INTERNAZIONALE

Malta
Romania
Mauritania
Marocco
Rep. Dominicana
Estonia

EE.UU.
Algeria
Slovenia
Belgio
Lussemburgo
Svizzera

Spagna
Portogallo
Andorra
Francia
Italia
Inghilterra



GME

IOΦ®

CHI SIAMO

GME DIVISIÓN BAÑOS S.L. è un gruppo imprenditoriale che appartiene a LORENTE HOLDING VLC. Con oltre 25 anni di esperienza nella commercializzazione e distribuzione di prodotti destinati all'allestimento integrale del bagno.

Il gruppo sviluppa due linee di business generali, una delle quali agisce come delegazione di produttori di primo livello, l'altra produce e commercializza prodotti con il marchio GME.

Grazie al contatto permanente con i nostri clienti attraverso la nostra vasta rete di vendita, sviluppiamo le linee di prodotti da commercializzare per soddisfare le attuali esigenze del mercato, cercando sempre di migliorare l'offerta esistente in termini di prezzo, qualità e servizio.



Il nostro magazzino di 25000 m² ci permette di avere un'ampia scorta di tutti gli articoli presenti in catalogo. Questo, insieme al nostro impegno a preparare gli ordini il giorno stesso in cui li riceviamo, fa sì che la partenza avvenga, in condizioni normali entro le successive 72 ore.

Tutto ciò consente di raggiungere il nostro obiettivo:
"La qualità ha un prezzo".

TWENTY 11-19

TWENTY SPAZIO 14-15

TWENTY ANGOLARE 16-17

BASIC 20-35

SCORREVOLE ALLUMINIO



NOVITÀ



NOVITÀ



KENNA 36-43

VITRO 44-55

PRESTIGE 56-65

AKTUAL 66-73



TWENTY GOLD 76-83

TWENTY BLACK 84-91

BASIC BLACK 92-103

BASIC WHITE 92-103

BASIC TITANIO 92-103

SCORREVOLE COLORE



NOVITÀ



VETRUM 106-117

TEMPLE 118-125

ROTARY 126-133

FUTURA 134-143

MOVING 144-153

SCORREVOLE ACCIAIO



SCREEN 156

SCREEN GOLD 158

SCREEN BLACK 160

SCREEN WHITE 162

BLACK SCACCHI 164



FISSI

OPEN 170-203

OPEN BLACK 204-225

GLASS 226-241



A BATTENTE

GLASS PIEGHEVOLE 244-247

G. PIEGHEVOLE BLACK 244-247 TANDEM 248

AKORD 250



PIEGHEVOLE

TRIO 254

BYPASS 256

GIRO 360° 258-261

PORTE DIVISORIE 262



+SOLUZIONI

OPEN 1 266



OPEN 1 BLACK 267



OPEN 2 268



GLASS VASCA PIEGHEVOLE 269



SCREEN VASCA 270



SCREEN BLACK VASCA 270



SCREEN GOLD VASCA 271



SCREEN WHITE VASCA 271



SOLUZIONI VASCA

BASIC VASCA 272-279



BASIC BLACK VASCA 272-279



BASIC WHITE VASCA 272-279



BASIC TITANIO VASCA 272-279



SU MISURA 280-285



RICAMBI 286-293



VINILI POLIMERICI 294



STAMPA DIGITALE 294



SU MISURA

PIATTI DOCCIA

ARDESIA PLUS 298



ARD. SEMICIRCOLARE 300



STYLE PLUS 302



SIDE PLUS 304



HIDDEN PLUS 306



RESITEC ROCK 308



PANNELLI 310



RIQUADRATI 311



MISCELATORI 315



DOCCIA 317



INCASSO LAV. 319



INCASSO 319



CUCINA 321



RUBINETTERIA

La gamma più ampia nel
mercato di box doccia
Con consegna immediata

TWENTY pg.10



BASIC pg.20



KENNA pg.36



VITRO pg.44

PRESTIGE pg.56

AKTUAL pg.66



**BOX DOCCIA
ALLUMINIO
SCORREVOLI**

twenty

20mm

"Tecnologia e bellezza con soli 20 mm di profilo e Soft Close"





TWENTY 1 fisso+1 scorrevole





Frontali TWENTY 1 fisso + 1 scorrevole

Descrizione	Estensibilità	Apertura	Art.
Frontale doccia TWENTY 120	115-120	46-51	2000+2021
Frontale doccia TWENTY 125	120-125	49-54	2001+2021
Frontale doccia TWENTY 130	125-130	51-56	2002+2021
Frontale doccia TWENTY 135	130-135	54-59	2003+2021
Frontale doccia TWENTY 140	135-140	56-61	2004+2021
Frontale doccia TWENTY 145	140-145	59-64	2005+2021
Frontale doccia TWENTY 150	145-150	61-66	2006+2021
Frontale doccia TWENTY 155	150-155	64-69	2007+2022
Frontale doccia TWENTY 160	155-160	66-71	2008+2022
Frontale doccia TWENTY 165	160-165	69-74	2009+2022
Frontale doccia TWENTY 170	165-170	71-76	2010+2022
Frontale doccia TWENTY 175	170-175	74-79	2011+2022
Frontale doccia TWENTY 180	175-180	76-81	2012+2022



Guida sganciabile



Cuscinetto occulto



Doppia maniglia metallica



Chiusura/apertura soft close



Box doccia su misura e cristalli speciali

TRASPARENTE

FROST PLUS
PARSOL / OPACO

TAGLIO

*Tempo di consegna 3 settimane (maggiori informazioni a pag. 280)

TWENTY SPAZIO 2 fissi+2 scorrevoli



Box doccia su misura e cristalli speciali

TRASPARENTE

FROST PLUS
PARSOL / OPACO

TAGLIO

*Tempo di consegna 3 settimane (maggiori informazioni a pag. 280)



TWENTY SPAZIO 2 fissi + 2 scorrevoli

Descrizione	Estensibilità	Apertura	Articoli
TWENTY SPAZIO 2F2S 140	131-141	44-54	2031+2031+2042
TWENTY SPAZIO 2F2S 150	141-151	49-59	2032+2032+2042
TWENTY SPAZIO 2F2S 160	151-161	54-64	2033+2033+2042
TWENTY SPAZIO 2F2S 170	161-171	59-69	2034+2034+2042
TWENTY SPAZIO 2F2S 180	171-181	64-74	2035+2035+2042
TWENTY SPAZIO 2F2S 190	181-191	69-79	2036+2036+2042

*Permette laterale fisso in entrambi i lati



Innovativo sistema antiribaltamento



Cuscinetto occulto



Doppia maniglia metallica



Apertura soft close

TWENTY apertura angolare



Box doccia su misura e cristalli speciali

TRASPARENTE

FROST PLUS
PARSOL / OPACO

TAGLIO

*Tempo di consegna 3 settimane (maggiori informazioni a pag. 280)



combinazioni frontali TWENTY + laterale fisso 6 mm

Cm	Estensibilità	Apertura	Articoli
70X70	65-70/65-70	30-35	2030+2030+2038
75X70	70-75/65-70	32-37	2031+2030+2038
80X70	75-80/65-70	34-39	2032+2030+2038
85X70	80-85/65-70	36-41	2033+2030+2038
90X70	85-90/65-70	38-43	2034+2030+2038
95X70	90-95/65-70	40-45	2035+2030+2038
100X70	95-100/65-70	42-47	2036+2030+2038
120X70	115-120/65-70	52-57	2037+2030+2038
Cm	Estensibilità	Apertura	Articoli
75X75	70-75/70-75	34-39	2031+2031+2038
80X75	75-80/70-75	36-41	2032+2031+2038
85X75	80-85/70-75	38-43	2033+2031+2038
90X75	85-90/70-75	40-45	2034+2031+2038
95X75	90-95/70-75	42-47	2035+2031+2038
100X75	95-100/70-75	45-50	2036+2031+2038
120X75	115-120/70-75	54-59	2037+2031+2038
Cm	Estensibilità	Apertura	Articoli
80X80	75-80/75-80	38-43	2032+2032+2038
85X80	80-85/75-80	40-45	2033+2032+2038
90X80	85-90/75-80	42-47	2034+2032+2038
95X80	90-95/75-80	45-50	2035+2032+2038
100X80	95-100/75-80	47-52	2036+2032+2038
120X80	115-120/75-80	56-61	2037+2032+2038
Cm	Estensibilità	Apertura	Articoli
90X90	85-90/85-90	47-52	2034+2034+2038
95X90	90-95/85-90	49-54	2035+2034+2038
100X90	95-100/85-90	50-55	2036+2034+2038
120X90	115-120/85-90	60-65	2037+2034+2038



Innovativo sistema antiribaltamento



Cuscinetto occulto



Doppia maniglia metallica



Apertura soft close

TWENTY frontale + laterale fisso 6 mm



Descrizione	Estensibilità	Art.	
Laterale fisso TWENTY 70	66,5-69,5	2013	
Laterale fisso TWENTY 75	71,5-74,5	2014	
Laterale fisso TWENTY 80	76,5-79,5	2015	
Laterale fisso TWENTY 90	86,5-89,5	2016	



combinazioni frontali TWENTY + laterale fisso 6 mm

Cm	Estensibilità	Articoli	P	Cm	Estensibilità	Articoli	P
120X70	115-120/66,5-69,5	2000+2021+2013	856	120X75	115-120/71,5-74,5	2000+2021+2014	
125X70	120-125/66,5-69,5	2001+2021+2013	862	125X75	120-125/71,5-74,5	2001+2021+2014	
130X70	125-130/66,5-69,5	2002+2021+2013	868	130X75	125-130/71,5-74,5	2002+2021+2014	
135X70	130-135/66,5-69,5	2003+2021+2013	874	135X75	130-135/71,5-74,5	2003+2021+2014	
140X70	135-140/66,5-69,5	2004+2021+2013	880	140X75	135-140/71,5-74,5	2004+2021+2014	
145X70	140-145/66,5-69,5	2005+2021+2013	886	145X75	140-145/71,5-74,5	2005+2021+2014	
150X70	145-150/66,5-69,5	2006+2021+2013	892	150X75	145-150/71,5-74,5	2006+2021+2014	
155X70	150-155/66,5-69,5	2007+2022+2013	975	155X75	150-155/71,5-74,5	2007+2022+2014	
160X70	155-160/66,5-69,5	2008+2022+2013	981	160X75	155-160/71,5-74,5	2008+2022+2014	
165X70	160-165/66,5-69,5	2009+2022+2013	987	165X75	160-165/71,5-74,5	2009+2022+2014	
170X70	165-170/66,5-69,5	2010+2022+2013	992	170X75	165-170/71,5-74,5	2010+2022+2014	
175X70	170-175/66,5-69,5	2011+2022+2013	999	175X75	170-175/71,5-74,5	2011+2022+2014	
180X70	175-180/66,5-69,5	2012+2022+2013	1005	180X75	175-180/71,5-74,5	2012+2022+2014	
Cm	Estensibilità	Articoli	P	Cm	Estensibilità	Articoli	P
120X80	115-120/76,5-79,5	2000+2021+2015	880	120X90	115-120/86,5-89,5	2000+2021+2016	
125X80	120-125/76,5-79,5	2001+2021+2015	886	125X90	120-125/86,5-89,5	2001+2021+2016	
130X80	125-130/76,5-79,5	2002+2021+2015	892	130X90	125-130/86,5-89,5	2002+2021+2016	
135X80	130-135/76,5-79,5	2003+2021+2015	898	135X90	130-135/86,5-89,5	2003+2021+2016	
140X80	135-140/76,5-79,5	2004+2021+2015	904	140X90	135-140/86,5-89,5	2004+2021+2016	
145X80	140-145/76,5-79,5	2005+2021+2015	910	145X90	140-145/86,5-89,5	2005+2021+2016	
150X80	145-150/76,5-79,5	2006+2021+2015	916	150X90	145-150/86,5-89,5	2006+2021+2016	
155X80	150-155/76,5-79,5	2007+2022+2015	999	155X90	150-155/86,5-89,5	2007+2022+2016	
160X80	155-160/76,5-79,5	2008+2022+2015	1005	160X90	155-160/86,5-89,5	2008+2022+2016	
165X80	160-165/76,5-79,5	2009+2022+2015	1011	165X90	160-165/86,5-89,5	2009+2022+2016	
170X80	165-170/76,5-79,5	2010+2022+2015	1016	170X90	165-170/86,5-89,5	2010+2022+2016	
175X80	170-175/76,5-79,5	2011+2022+2015	1023	175X90	170-175/86,5-89,5	2011+2022+2016	
180X80	175-180/76,5-79,5	2012+2022+2015	1029	180X90	175-180/86,5-89,5	2012+2022+2016	

Le aperture sono le stesse dei frontali. *Permette laterale fisso in entrambi i lati.



Laterali fissi su misura (maggiori informazioni a pagina 282)

Descrizione	Articoli	P	Taglio
Lat. fisso su misura TWENTY fino 40 cm	1375		
Lat. fisso su misura TWENTY da 40 fino 80 cm	1376		
Lat. fisso su misura TWENTY da 80 fino 120 cm	1377		

*Tempo di consegna 3 settimane

basic

"Un rapporto qualità-prezzo imbattibile e un'ampia gamma di formati, dimensioni e colori".





BASIC 1 fisso + 1 scorrevole





Frontali BASIC 1 fisso + 1 scorrevole

Cm	Apertura	TRASPARENTE		FROST PLUS	
		Art.	P	Art.	
95-100	36-41	5401	482	6401	
100-105	36-41	5402	492	6402	
105-110	41-46	5403	501	6403	
110-115	41-46	5404	509	6404	
115-120	46-51	5405	515	6405	
120-125	46-51	5406	525	6406	
125-130	51-56	5407	533	6407	
130-135	51-56	5408	539	6408	
135-140	56-61	5409	548	6409	
140-145	56-61	5410	567	6410	
145-150	61-66	5411	575	6411	
150-155	61-66	5412	585	6412	
155-160	61-66	5413	593	6413	
160-165	61-66	5414	599	6414	
165-170	66-71	5415	602	6415	
170-175	66-71	5416	611	6416	
175-180	66-71	5417	620	6417	
180-190	66-71	*5455	661	*6455	
190-200	66-71	*5456	677	*6456	

*L'incrocio delle ante tra i codici 5455, 5456, 6455 e 6456 sarà 1-11 cm.

Composizione per articoli/prezzo a pagina 293.

Descrizione	Articoli
Profilo espansione +1,5 cm	5429
Adorno in alluminio 195x3,8 cm	0007



Innovativo sistema di guide con pulsante per liberare l'anta e facilitarne la pulizia



Doppio cuscinetto di ultima generazione in nylon



Adorno in alluminio opzionale



Opzione maniglia	Art.
Ultrapiatte 22x1,6x0,7 cm	1731
Lunga 40x1,2x1,5 cm	1732



Box doccia su misura e cristalli speciali	TRASPARENTE	FROST PLUS PARSOL / OPACO
Altezza fino 195 cm		
Altezza 195 a 220 cm		

*Tempo di consegna 3 settimane (maggiori informazioni a pag. 280)

BASIC SPAZIO 2 fissi + 2 scorrevoli



Frontali BASIC SPAZIO 2 fissi + 2 scorrevoli

Descrizione	Estensibilità	Apertura	Incrocio	Articoli
BASIC SPAZIO 140 (75+75)	132-142	46-56	1-6	5029+5029+5451
BASIC SPAZIO 150 (80+80)	142-152	56-66	1-6	5019+5019+5451
BASIC SPAZIO 160 (85+85)	152-162	54-64	1-6	5030+5030+5451
BASIC SPAZIO 170 (90+90)	162-172	66-76	1-6	5020+5020+5451
BASIC SPAZIO 180 (95+95)	172-182	62-72	1-6	5031+5031+5454
BASIC SPAZIO 190 (100+100)	182-192	76-86	1-6	5021+5021+5454
BASIC SPAZIO 200 (100+100)	190-200	76-86	1-6	5001+5001+5454
BASIC SPAZIO 210 (105+105)	200-210	76-86	1-6	5002+5002+5454

Si può combinare con il laterale fisso (vedi pag. 30), utilizzando art. 0182 (indicare il verso). L'estensibilità aumenta 1,2 cm in uno dei lati.
 *Composizione per articoli/prezzo a pagina 293.

Descrizione	Art.
Profilo espansione +1,5 cm	5429
Profilo di unione fisso-fisso (indicare il verso), vedi pag. 167	0182

Box doccia su misura e cristalli speciali	TRANSP.	FROST PLUS PARSOL /OPACO
Altezza fino 195 cm		
Altezza 195 fino 220 cm		

*Tempo di consegna 3 settimane (maggiori informazioni a pag. 280)

BASIC SPAZIO FROST PLUS 2 fissi + 2 scorrevoli



Frontali BASIC SPAZIO FROST PLUS 2 fissi + 2 scorrevoli

Descrizione	Estensibilità	Apertura	Incrocio	Articoli
BASIC SPAZIO FROST PLUS 140 (75+75)	132-142	46-56	1-6	6029+6029+5451
BASIC SPAZIO FROST PLUS 150 (80+80)	142-152	56-66	1-6	6019+6019+5451
BASIC SPAZIO FROST PLUS 160 (85+85)	152-162	54-64	1-6	6030+6030+5451
BASIC SPAZIO FROST PLUS 170 (90+90)	162-172	66-76	1-6	6020+6020+5451
BASIC SPAZIO FROST PLUS 180 (95+95)	172-182	62-72	1-6	6031+6031+5454
BASIC SPAZIO FROST PLUS 190 (100+100)	182-192	76-86	1-6	6021+6021+5454
BASIC SPAZIO FROST PLUS 200 (100+100)	190-200	76-86	1-6	6001+6001+5454
BASIC SPAZIO FROST PLUS 210 (105+105)	200-210	76-86	1-6	6002+6002+5454

Si può combinare con il laterale fisso (vedi pag. 30), utilizzando art. 0182 (indicare il verso). L'estensibilità aumenta 1,2 cm in uno dei lati.

*Composizione per articoli/prezzo a pagina 293.

Descrizione	Art.
profilo espansione +1,5 cm	5429
profilo di unione fisso-fisso (indicare il verso), vedi pag. 167	0182

Box doccia su misura e cristalli speciali	TRANSP.	FROST PLUS PARSOL /OPACO
Altezza fino 195 cm		
Altezza 195 fino 220 cm		

*Tempo di consegna 3 settimane (maggiori informazioni a pag. 280)

BASIC fisso + porta + fisso



Si può combinare con il laterale fisso (vedi pag. 30), usando art. 0182 (indicare il verso). L'estensibilità aumenta 1,2 cm in uno dei lati. Composizione per articoli/prezzo a pagina 293.



Gomme trasparenti antingiallenti



Doppio cuscinetto di ultima generazione in nylon



Maniglia in metallo



Innovativo sistema di guide con pulsante per liberare l'anta e facilitarne la pulizia



PASSO 1: Selezionare la misura dei PROFILI

PASSO 2: Selezionare la misura/finitura FISSO IN LINEA

PASSO 3: Selezionare la misura/finitura dei FRONTALI

Estensibilità = (Estens. Min/Max frontale + Misura fisso in linea)

PASSO 1: PROFILI

Descrizione	Art.	
Accessori frontali fino 140 cm (2 cuscinetti)	5434	
Accessori frontali fino 180 cm (2 cuscinetti)	5438	
Accessori frontali fino 200 cm (3 cuscinetti)	5446	

PASSO 2: FISSO IN LINEA

Cm fisso	TRASPARENTE		FROST PLUS	
	Art.		Art.	
Fisso da 30 cm + magnete di unione	5018F+5467		6018F+5467	
Fisso da 35 cm + magnete di unione	5019F+5467		6019F+5467	
Fisso da 40 cm + magnete di unione	5020F+5467		6020F+5467	
Fisso da 45 cm + magnete di unione	5021F+5467		6021F+5467	
Fisso da 52 cm + magnete di unione	5002F+5467		6002F+5467	
Fisso da 55 cm + magnete di unione	5022F+5467		6022F+5467	
Fisso da 57 cm + magnete di unione	5004F+5467		6004F+5467	

PASSO 3: FRONTALI

Descrizione	Estensibilità (cm)	TRASPARENTE		FROST PLUS	
		Art.		Art.	
Cristallo fisso + porta frontale da 100	95-100	5001		6001	
Cristallo fisso + porta frontale da 105	100-105	5002		6002	
Cristallo fisso + porta frontale da 110	105-110	5003		6003	
Cristallo fisso + porta frontale da 115	110-115	5004		6004	
Cristallo fisso + porta frontale da 120	115-120	5005		6005	
Cristallo fisso + porta frontale da 125	120-125	5006		6006	
Cristallo fisso + porta frontale da 130	125-130	5007		6007	
Cristallo fisso + porta frontale da 135	130-135	5008		6008	
Cristallo fisso + porta frontale da 140	135-140	5009		6009	
Cristallo fisso + porta frontale da 145	140-145	5010		6010	
Cristallo fisso + porta frontale da 150	145-150	5011		6011	
Cristallo fisso + porta frontale da 155	150-155	5012		6012	
Cristallo fisso + porta frontale da 160	155-160	5013		6013	
Cristallo fisso + porta frontale da 165	160-165	5014		6014	
Cristallo fisso + porta frontale da 170	165-170	5015L		6015L	
Cristallo fisso + porta frontale da 175	170-175	5016L		6016L	
Cristallo fisso + porta frontale da 180	175-180	5017L		6017L	
Cristallo fisso + porta frontale da 190	180-190	5023L		6023L	
Cristallo fisso + porta frontale da 200	190-200	5024L		6024L	



Fissi in linea su misura + magnete

Descrizione
misura fino 40 cm
misura da 40 fino 80 cm

Descrizione	TRASPARENTE		FROST PLUS		Taglio
	Art.		Art.		
misura fino 40 cm	1370		1372		
misura da 40 fino 80 cm	1371		1373		

*Tempo di consegna 3 settimane

BASIC apertura angolare



Box doccia su misura e cristalli speciali	TRASPARENTE	FROST PLUS PARSOL / OPACO	TAGLIO
Altezza fino 195 cm			
Altezza 195 a 220 cm			

*Tempo di consegna 3 settimane (maggiori informazioni a pag. 280)



BASIC apertura angolare

			TRASPARENTE		FROST PLUS	
Cm	Estensibilità	Apertura	Articoli		Articoli	
70x70	65-70/65-70	34-37	5018+5018+5423		6018+6018+5423	
75x70	70-75/65-70	36-39	5029+5018+5423		6029+6018+5423	
80x70	75-80/65-70	38-41	5019+5018+5423		6019+6018+5423	
85x70	80-85/65-70	40-43	5030+5018+5423		6030+6018+5423	
90x70	85-90/65-70	41-45	5020+5018+5423		6020+6018+5423	
95x70	90-95/65-70	43-47	5031+5018+5423		6031+6018+5423	
100x70	95-100/65-70	46-49	5021+5018+5423		6021+6018+5423	
110x70	105-109/65-70	47-50	5002+5018+5423		6002+6018+5423	
120x70	115-120/65-70	50-53	5022+5018+5423		6022+6018+5423	
130x70	125-129/65-70	55-58	5006+5018+5424		6006+6018+5424	
140x70	135-139/65-70	59-62	5008+5018+5424		6008+6018+5424	
Cm	Estensibilità	Apertura	Articoli		Articoli	
75x75	70-75/70-75	38-41	5029+5029+5423		6029+6029+5423	
80x75	75-80/70-75	40-43	5019+5029+5423		6019+6029+5423	
85x75	80-85/70-75	42-45	5030+5029+5423		6030+6029+5423	
90x75	85-90/70-75	45-48	5020+5029+5423		6020+6029+5423	
95x75	90-95/70-75	47-50	5031+5029+5423		6031+6029+5423	
100x75	95-100/70-75	48-51	5021+5029+5423		6021+6029+5423	
110x75	105-109/70-75	49-52	5002+5029+5423		6002+6029+5423	
120x75	115-120/70-75	52-55	5022+5029+5423		6022+6029+5423	
130x75	125-129/70-75	57-60	5006+5029+5424		6006+6029+5424	
140x75	135-139/70-75	61-64	5008+5029+5424		6008+6029+5424	
Cm	Estensibilità	Apertura	Articoli		Articoli	
80x80	75-80/75-80	41-44	5019+5019+5423		6019+6019+5423	
85x80	80-85/75-80	43-46	5030+5019+5423		6030+6019+5423	
90x80	85-90/75-80	45-48	5020+5019+5423		6020+6019+5423	
95x80	90-95/75-80	47-50	5031+5019+5423		6031+6019+5423	
100x80	95-100/75-80	49-52	5021+5019+5423		6021+6019+5423	
110x80	105-109/75-80	50-53	5002+5019+5423		6002+6019+5423	
120x80	115-120/75-80	53-56	5022+5019+5423		6022+6019+5423	
130x80	125-129/75-80	57-60	5006+5019+5424		6006+6019+5424	
140x80	135-139/75-80	62-65	5008+5019+5424		6008+6019+5424	
Cm	Estensibilità	Apertura	Articoli		Articoli	
85x90	80-85/85-90	46-49	5030+5020+5423		6030+6020+5423	
90x90	85-90/85-90	48-51	5020+5020+5423		6020+6020+5423	
95x90	90-95/85-90	50-53	5031+5020+5423		6031+6020+5423	
100x90	95-100/85-90	52-55	5021+5020+5423		6021+6020+5423	
110x90	105-109/85-90	53-56	5002+5020+5423		6002+6020+5423	
120x90	115-120/85-90	57-62	5022+5020+5423		6022+6020+5423	
130x90	125-129/85-90	60-63	5006+5020+5424		6006+6020+5424	
140x90	135-139/85-90	64-67	5008+5020+5424		6008+6020+5424	

*Composizione per articoli/prezzo a pagina 293.

Descrizione	Articoli
profilo espansione +1,5 cm	5429

BASIC frontale + laterale fisso 8 mm



Descrizione	Estensibilità	TRASPARENTE		FROST PLUS	
		Art.		Art.	
Laterale fisso BASIC 70	67-69	5425		6425	
Laterale fisso BASIC 75	72-74	5457		6457	
Laterale fisso BASIC 80	77-79	5426		6426	
Laterale fisso BASIC 90	87-89	5427		6427	



Laterali fissi su misura

Descrizione
Misura fino 40 cm
Misura da 40 fino 80 cm
Misura da 80 fino 120 cm

TRASPARENTE	
Art.	
1350	
1334	
1335	

FROST PLUS	
Art.	
1350+1312	
1334+1313	
1335+1315	

Taglio

*Tempo di consegna 3 settimane



combinazioni frontali **BASIC** + laterale fisso 8 mm

			TRASPARENTE		FROST PLUS	
Cm	Estensibilità	Apertura	Articoli		Articoli	
100x70	95-100/67-69	38-43	5401+5425		6401+6425	
110x70	105-110/67-69	43-48	5403+5425		6403+6425	
120x70	115-120/67-69	48-53	5405+5425		6405+6425	
130x70	125-130/67-69	53-58	5407+5425		6407+6425	
140x70	135-140/67-69	58-63	5409+5425		6409+6425	
150x70	145-150/67-69	63-68	5411+5425		6411+6425	
160x70	155-160/67-69	63-68	5413+5425		6413+6425	
170x70	165-170/67-69	68-73	5415+5425		6415+6425	
180x70	175-180/67-69	68-73	5417+5425		6417+6425	
100x75	95-100/72-74	38-43	5401+5457		6401+6457	
110x75	105-110/72-74	43-48	5403+5457		6403+6457	
120x75	115-120/72-74	48-53	5405+5457		6405+6457	
130x75	125-130/72-74	53-58	5407+5457		6407+6457	
140x75	135-140/72-74	58-63	5409+5457		6409+6457	
150x75	145-150/72-74	63-68	5411+5457		6411+6457	
160x75	155-160/72-74	63-68	5413+5457		6413+6457	
170x75	165-170/72-74	68-73	5415+5457		6415+6457	
180x75	175-180/72-74	68-73	5417+5457		6417+6457	
100x80	95-100/77-79	38-43	5401+5426		6401+6426	
110x80	105-110/77-79	43-48	5403+5426		6403+6426	
120x80	115-120/77-79	48-53	5405+5426		6405+6426	
130x80	125-130/77-79	53-58	5407+5426		6407+6426	
140x80	135-140/77-79	58-63	5409+5426		6409+6426	
150x80	145-150/77-79	63-68	5411+5426		6411+6426	
160x80	155-160/77-79	63-68	5413+5426		6413+6426	
170x80	165-170/77-79	68-73	5415+5426		6415+6426	
180x80	175-180/77-79	68-73	5417+5426		6417+6426	
100x90	95-100/87-89	38-43	5401+5427		6401+6427	
110x90	105-110/87-89	43-48	5403+5427		6403+6427	
120x90	115-120/87-89	48-53	5405+5427		6405+6427	
130x90	125-130/87-89	53-58	5407+5427		6407+6427	
140x90	135-140/87-89	58-63	5409+5427		6409+6427	
150x90	145-150/87-89	63-68	5411+5427		6411+6427	
160x90	155-160/87-89	63-68	5413+5427		6413+6427	
170x90	165-170/87-89	68-73	5415+5427		6415+6427	
180x90	175-180/87-89	68-73	5417+5427		6417+6427	

Si possono fare abbinamenti con misure intermedie dei frontali fino a 2 m

Descrizione	Articolo
Profilo espansione +1,5 cm (valido solo per frontale)	5429
Profilo di unione fisso-fisso (indicare il verso), vedi pag. 167	0182

BASIC FREE

Aumento del passaggio di entrata / Prezzo inferiore / Stessa funzione





H196

Altezza

1-6
cm

Incrocio



6mm

Vetro



Scorrevoli



Reversibile

aluminio
AL
aluminiumclear
tinted
glass● Nero
○ Bianco
● Titanio
vedi pag. 92

PASSO 1: selezionare la misura dei profili
PASSO 2: selezionare la misura dei cristalli

PASSO 1: PROFILI

Descrizione	Art.
Profili ed accessori fino 140 + KIT FREE	5434+5447
Profili ed accessori fino 180 + KIT FREE	5438+5447
Profili ed accessori fino 200 + KIT FREE	5446+5447

Composizione per articoli/prezzo a pagina 293.

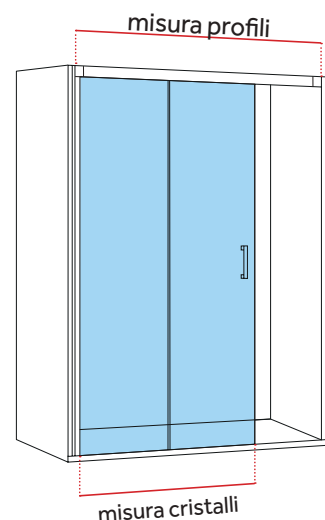

PASSO 2: CRISTALLI

Descrizione	Estensibilità
BASIC FREE 100	95-100
BASIC FREE 105	100-105
BASIC FREE 110	105-110
BASIC FREE 115	110-115
BASIC FREE 120	115-120
BASIC FREE 125	120-125
BASIC FREE 130	125-130
BASIC FREE 135	130-135
BASIC FREE 140	135-140
BASIC FREE 145	140-145
BASIC FREE 150	145-150
BASIC FREE 155	150-155
BASIC FREE 160	155-160
BASIC FREE 165	160-165
BASIC FREE 170	165-170
BASIC FREE 175	170-175
BASIC FREE 180	175-180
BASIC FREE 190	180-190
BASIC FREE 200	190-200

TRASPARENTE		FROST PLUS	
Art.		Art.	
5001		6001	
5002		6002	
5003		6003	
5004		6004	
5005		6005	
5006		6006	
5007		6007	
5008		6008	
5009		6009	
5010		6010	
5011		6011	
5012		6012	
5013		6013	
5014		6014	
5015L		6015L	
5016L		6016L	
5017L		6017L	
5023L		6023L	
5024L		6024L	



Profileria in alluminio lucido con freno anti-ribaltamento



Doppio cuscinetto di ultima generazione in nylon



Adorno in alluminio opzionale



Innovativo sistema di guide con pulsante per liberare l'anta e facilitarne la pulizia

BASIC FREE ANGULAR

Aumento del passaggio di entrata / Prezzo inferiore / Stessa funzione



Box doccia su misura e cristalli speciali	TRASPARENTE	FROST PLUS PARSOL / OPACO	TAGLIO
Altezza fino 195 cm			
Altezza 195 a 220 cm			

*Tempo di consegna 3 settimane (maggiori informazioni a pag. 280)



H196

Altezza

1-6
cm

Incrocio



6mm

Vetro



Scorrevoli



Reversibile

aluminio
AL
aluminiumclear
shield
glass● Nero
○ Bianco
● Titanio
vedi pag. 92combinazioni angolari **BASIC FREE**

Cm		Estensibilità		TRASPARENTE		FROST PLUS	
Cm		Articoli		Articoli		Articoli	
70x70		5018+5423+5447		6018+5423+5447			
75x70		5029+5423+5447		6029+5423+5447			
80x70		5019+5423+5447		6019+5423+5447			
85x70		5030+5423+5447		6030+5423+5447			
90x70		5020+5423+5447		6020+5423+5447			
95x70		5031+5423+5447		6031+5423+5447			
100x70		5021+5423+5447		6021+5423+5447			
110x70		5002+5423+5447		6002+5423+5447			
120x70		5022+5423+5447		6022+5423+5447			
130x70		5006+5424+5447		6006+5424+5447			
140x70		5008+5424+5447		6008+5424+5447			
Cm		Articoli		Articoli		Articoli	
75x75		5029+5423+5447		6029+5423+5447			
80x75		5019+5423+5447		6019+5423+5447			
85x75		5030+5423+5447		6030+5423+5447			
90x75		5020+5423+5447		6020+5423+5447			
95x75		5031+5423+5447		6031+5423+5447			
100x75		5021+5423+5447		6021+5423+5447			
110x75		5002+5423+5447		6002+5423+5447			
120x75		5022+5423+5447		6022+5423+5447			
130x75		5006+5424+5447		6006+5424+5447			
140x75		5008+5424+5447		6008+5424+5447			
Cm		Articoli		Articoli		Articoli	
80x80		5019+5423+5447		6019+5423+5447			
85x80		5030+5423+5447		6030+5423+5447			
90x80		5020+5423+5447		6020+5423+5447			
95x80		5031+5423+5447		6031+5423+5447			
100x80		5021+5423+5447		6021+5423+5447			
110x80		5002+5423+5447		6002+5423+5447			
120x80		5022+5423+5447		6022+5423+5447			
130x80		5006+5424+5447		6006+5424+5447			
140x80		5008+5424+5447		6008+5424+5447			
Cm		Articoli		Articoli		Articoli	
90x90		5020+5423+5447		6020+5423+5447			
95x90		5031+5423+5447		6031+5423+5447			
100x90		5021+5423+5447		6021+5423+5447			
110x90		5002+5423+5447		6002+5423+5447			
120x90		5022+5423+5447		6022+5423+5447			
130x90		5006+5424+5447		6006+5424+5447			
140x90		5008+5424+5447		6008+5424+5447			

*Composizione per articoli/prezzo a pagina 293.

Descrizione	Articoli
profilo espansione +1,5 cm	5429

kenna

8mm

"Design all'avanguardia con assenza di profili con porta scorrevole interna."





KENNA 1 fisso + 1 scorrevole





Frontali KENNA 1 fisso + 1 scorrevole

Descrizione	Estensibilità	Apertura	Art.
Frontale doccia KENNA 100	95-100	34-39	6530
Frontale doccia KENNA 105	100-105	37-42	6531
Frontale doccia KENNA 110	105-110	39-44	6532
Frontale doccia KENNA 115	110-115	42-47	6533
Frontale doccia KENNA 120	115-120	44-49	6534
Frontale doccia KENNA 125	120-125	47-52	6535
Frontale doccia KENNA 130	125-130	49-54	6536
Frontale doccia KENNA 135	130-135	52-57	6537
Frontale doccia KENNA 140	135-140	52-57	6538
Frontale doccia KENNA 145	140-145	57-62	6539
Frontale doccia KENNA 150	145-150	57-62	6540
Frontale doccia KENNA 155	150-155	62-67	6541
Frontale doccia KENNA 160	155-160	64-69	6542
Frontale doccia KENNA 165	160-165	64-69	6543
Frontale doccia KENNA 170	165-170	64-69	6544
Frontale doccia KENNA 175	170-175	64-69	6545
Frontale doccia KENNA 180	175-180	64-69	6546



Opzione barra parallela 200 cm, art. 5546



Barra e guida snodabile in acciaio



Opzione barra parallela



Doppia maniglia metallica



Cuscinetto interno anta

KENNA FREE 1 fisso+1 scorrevole



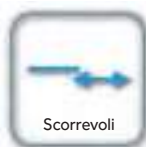

Frontali KENNA FREE 1 fisso + 1 scorrevole

Descrizione	Estensibilità	Descrizione	
Frontale doccia KENNA free 100	93-98	6530	
Frontale doccia KENNA free 105	98-103	6531	
Frontale doccia KENNA free 110	103-108	6532	
Frontale doccia KENNA free 115	108-113	6533	
Frontale doccia KENNA free 120	113-118	6534	
Frontale doccia KENNA free 125	118-123	6535	
Frontale doccia KENNA free 130	123-128	6536	
Frontale doccia KENNA free 135	128-133	6537	
Frontale doccia KENNA free 140	133-138	6538	
Frontale doccia KENNA free 145	138-143	6539	
Frontale doccia KENNA free 150	143-148	6540	
Frontale doccia KENNA free 155	148-153	6541	
Frontale doccia KENNA free 160	153-158	6542	
Frontale doccia KENNA free 165	158-163	6543	
Frontale doccia KENNA free 170	163-168	6544	
Frontale doccia KENNA free 175	168-173	6545	
Frontale doccia KENNA free 180	173-178	6546	



Barra e guida snodabile in acciaio



Doppia maniglia metallica



Cuscinetto interno anta



Opzione barra parallela

KENNA frontale + laterale fisso 8 mm



Descrizione	Estensibilità	Art.	
Laterale fisso KENNA 70	67-69	6547	
Laterale fisso KENNA 75	72-74	6548	
Laterale fisso KENNA 80	77-79	6549	
Laterale fisso KENNA 90	87-89	6550	

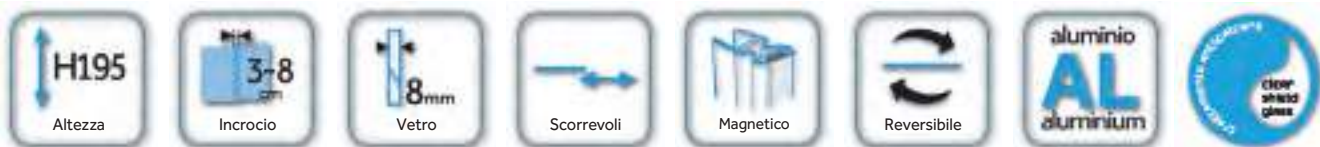

Combinazioni frontali KENNA + laterale fisso 8 mm

Cm	Estensibilità	Articoli	Cm	Estensibilità	Articoli
100x70	95-100/67-69	6530+6547	100x75	95-100/72-74	6530+6548
110x70	105-110/67-69	6532+6547	110x75	105-110/72-74	6532+6548
120x70	115-120/67-69	6534+6547	120x75	115-120/72-74	6534+6548
130x70	125-130/67-69	6536+6547	130x75	125-130/72-74	6536+6548
140x70	135-140/67-69	6538+6547	140x75	135-140/72-74	6538+6548
150x70	145-150/67-69	6540+6547	150x75	145-150/72-74	6540+6548
160x70	155-160/67-69	6542+6547	160x75	155-160/72-74	6542+6548
170x70	165-170/67-69	6544+6547	170x75	165-170/72-74	6544+6548
180x70	175-180/67-69	6546+6547	180x75	175-180/72-74	6546+6548
Cm	Estensibilità	Articoli	Cm	Estensibilità	Articoli
100x80	95-100/77-79	6530+6549	100x90	95-100/87-89	6530+6550
110x80	105-110/77-79	6532+6549	110x90	105-110/87-89	6532+6550
120x80	115-120/77-79	6534+6549	120x90	115-120/87-89	6534+6550
130x80	125-130/77-79	6536+6549	130x90	125-130/87-89	6536+6550
140x80	135-140/77-79	6538+6549	140x90	135-140/87-89	6538+6550
150x80	145-150/77-79	6540+6549	150x90	145-150/87-89	6540+6550
160x80	155-160/77-79	6542+6549	160x90	155-160/87-89	6542+6550
170x80	165-170/77-79	6544+6549	170x90	165-170/87-89	6544+6550
180x80	175-180/77-79	6546+6549	180x90	175-180/87-89	6546+6550

Si possono fare combinazioni con misure intermedie dei frontali fino 175 cm. La apertura +2 cm del frontale.



Doppia maniglia metallica



Cuscinetto interno anta



Barra e guida snodabile in acciaio



Laterali fissi su misura (maggiori informazioni a pagina 282)

Descrizione	Art.	Taglio
misura fino 40 cm	1365	
misura da 40 fino 80 cm	1366	
misura da 80 fino 120 cm	1367	

*Tempo di consegna 3 settimane

vitro

"L'importanza del vetro con il suo design innovativo"

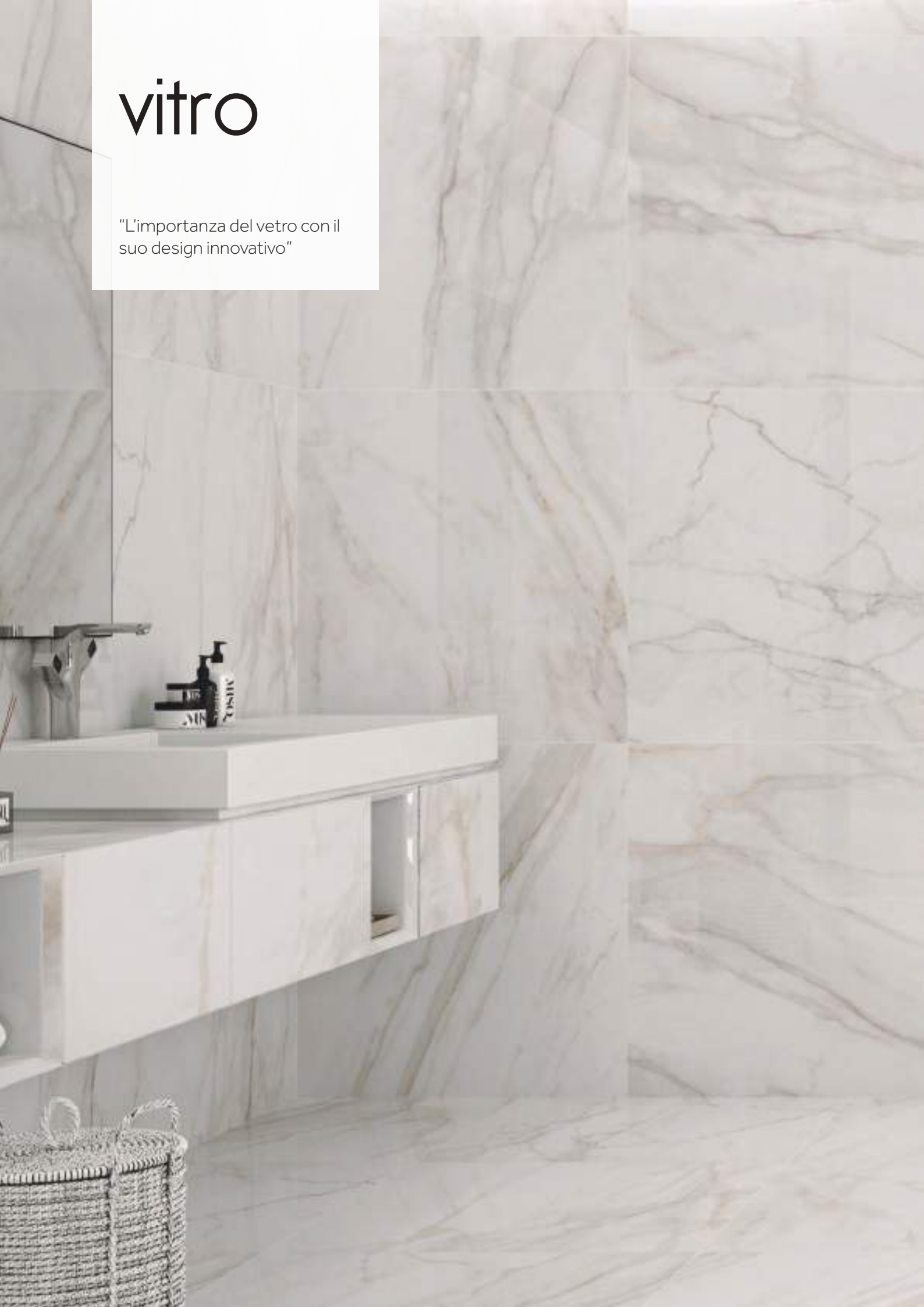



VITRO 1 fisso + 1 scorrevole



Box doccia su misura e cristalli speciali

TRASPARENTE

FROST PLUS
PARSOL / OPACO

TAGLIO

*Tempo di consegna 3 settimane (maggiori informazioni a pag. 280)



Frontali VITRO

Descrizione	Estensibilità	Apertura	Articoli
Frontale doccia VITRO 100	95-100	36-41	5501
Frontale doccia VITRO 105	100-105	36-41	5502
Frontale doccia VITRO 110	105-110	41-46	5503
Frontale doccia VITRO 115	110-115	41-46	5504
Frontale doccia VITRO 120	115-120	46-51	5505
Frontale doccia VITRO 125	120-125	46-51	5506
Frontale doccia VITRO 130	125-130	51-56	5507
Frontale doccia VITRO 135	130-135	51-56	5508
Frontale doccia VITRO 140	135-140	56-61	5509
Frontale doccia VITRO 145	140-145	56-61	5510
Frontale doccia VITRO 150	145-150	61-66	5511
Frontale doccia VITRO 155	150-155	61-66	5512
Frontale doccia VITRO 160	155-160	61-66	5513
Frontale doccia VITRO 165	160-165	61-66	5514
Frontale doccia VITRO 170	165-170	66-71	5515
Frontale doccia VITRO 175	170-175	66-71	5516
Frontale doccia VITRO 180	175-180	66-71	5517
Profilo espansione +1,5 cm			5429
Opzione barra inox parallela fino 2 m			5546
Adorno in alluminio 195x3,8 cm			0007

Composizione per articoli/prezzo a pagina 293.

OPZIONE VITRO FREE



L'estensibilità perde 2 cm

OPZIONE BARRA PARALLELA ref 5546



VITRO SPAZIO 2 fissi + 2 scorrevoli





Frontali VITRO SPAZIO 2 fissi + 2 scorrevoli

Descrizione	Estensibilità	Apertura	Articoli
VITRO SPAZIO 140 (75+75)	130-140	44-54	5029+5029+5552
VITRO SPAZIO 150 (80+80)	140-150	54-64	5019+5019+5552
VITRO SPAZIO 160 (85+85)	150-160	62-72	5030+5030+5552
VITRO SPAZIO 170 (90+90)	160-170	54-74	5020+5020+5552
VITRO SPAZIO 180 (95+95)	170-180	70-80	5031+5031+5554
VITRO SPAZIO 190 (100+100)	180-190	64-84	5021+5021+5554
VITRO SPAZIO 200 (100+100)	188-198	74-84	5001+5001+5554
VITRO SPAZIO 210 (105+105)	198-208	74-84	5002+5002+5554
Adorno in alluminio 195x3,8 cm			0007

Si può combinare con il laterale fisso di pag. 52 usando art. 0182. L'estensibilità aumenta 1,2 cm in uno dei lati.
Composizione per articoli/prezzo a pagina 293.



Cuscinetto interno guida



Riduzione dist. tra i cristalli



Braccetto orientabile



	TRASPARENTE	FROST PLUS PARSOL / OPACO	TAGLIO
Box doccia su misura e cristalli speciali			

*Tempo di consegna 3 settimane (maggiori informazioni a pag. 280)

VITRO apertura angolare



Guida e supporto fisso in acciaio



Maniglia in metallo



Nuovo cuscin. minimal blindato



Riduzione dist. tra i cristalli



Combinazioni VITRO apertura angolare

Cm	Estensibilità	Apertura	Articoli
70X67	62-67/62-67	32-35	5018+5018+5523
80X67	72-77/62-67	36-39	5019+5018+5523
90X67	82-87/62-67	40-43	5020+5018+5523
100X67	92-97/62-67	43-46	5021+5018+5523
110X67	105-110/62-67	47-50	5003+5018+5523
120X67	112-117/62-67	49-52	5022+5018+5523
130X67	125-130/62-67	50-53	5007+5018+5524
140X67	135-140/62-67	55-58	5009+5018+5524
Cm	Estensibilità	Apertura	Articoli
80X72	77-82/67-72	39-42	5030+5029+5523
90X72	87-92/67-72	42-45	5031+5029+5523
100X72	95-100/67-72	46-49	5001+5029+5523
110X72	105-110/67-72	48-51	5003+5029+5523
120X72	112-117/67-72	50-53	5022+5029+5523
130X72	125-130/67-72	51-54	5007+5029+5524
140X72	135-140/67-72	56-59	5009+5029+5524
Cm	Estensibilità	Apertura	Articoli
75X77	72-77/72-77	38-41	5019+5019+5523
80X77	77-82/72-77	40-43	5030+5019+5523
90X77	87-92/72-77	44-47	5031+5019+5523
100X77	95-100/72-77	48-51	5001+5019+5523
110X77	105-110/72-77	50-53	5003+5019+5523
120X77	112-117/72-77	51-54	5022+5019+5523
130X77	125-130/72-77	56-59	5007+5019+5524
140X77	135-140/72-77	59-62	5009+5019+5524
Cm	Estensibilità	Apertura	Articoli
80X82	77-82/77-82	42-45	5030+5030+5523
90X82	87-92/77-82	46-49	5031+5030+5523
100X82	95-100/77-82	50-53	5001+5030+5523
110X82	105-110/77-82	51-54	5003+5030+5523
120X82	112-117/77-82	56-59	5022+5030+5523
130X82	125-130/77-82	59-62	5007+5030+5524
140X82	135-140/77-82	61-64	5009+5030+5524
Cm	Estensibilità	Apertura	Articoli
90X92	87-92/87-92	46-49	5031+5031+5523
100X92	95-100/87-92	50-53	5001+5031+5523
110X92	105-110/87-92	51-54	5003+5031+5523
120X92	112-117/87-92	56-59	5022+5031+5523
130X92	125-130/87-92	59-62	5007+5031+5524
140X92	135-140/87-92	63-66	5009+5031+5524

Adorno in alluminio 195x3,8 cm

0007

Si possono combinare frontali di misure intermedie, estensibilità +2 cm. Composizione per articoli/prezzo a pagina 293.

VITRO frontale + laterale fisso 8 mm



Descrizione	Estensibilità	Articoli	
Laterale fisso VITRO 70	67-69	5525	
Laterale fisso VITRO 75	72-74	5557	
Laterale fisso VITRO 80	77-79	5526	
Laterale fisso VITRO 90	87-89	5527	

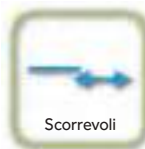

Combinazioni frontali VITRO + laterale fisso 8 mm

Cm	Estensibilità	Articoli	Cm	Estensibilità	Articoli
100x70	95-100/67-69	5501+5525	100x75	95-100/72-74	5501+5557
110x70	105-110/67-69	5503+5525	110x75	105-110/72-74	5503+5557
120x70	115-120/67-69	5505+5525	120x75	115-120/72-74	5505+5557
130x70	125-130/67-69	5507+5525	130x75	125-130/72-74	5507+5557
140x70	135-140/67-69	5509+5525	140x75	135-140/72-74	5509+5557
150x70	145-150/67-69	5511+5525	150x75	145-150/72-74	5511+5557
160x70	155-160/67-69	5513+5525	160x75	155-160/72-74	5513+5557
170x70	165-170/67-69	5515+5525	170x75	165-170/72-74	5515+5557
180x70	175-180/67-69	5517+5525	180x75	175-180/72-74	5517+5557
Cm	Estensibilità	Articoli	Cm	Estensibilità	Articoli
100x80	95-100/77-79	5501+5526	100x90	95-100/87-89	5501+5527
110x80	105-110/77-79	5503+5526	110x90	105-110/87-89	5503+5527
120x80	115-120/77-79	5505+5526	120x90	115-120/87-89	5505+5527
130x80	125-130/77-79	5507+5526	130x90	125-130/87-89	5507+5527
140x80	135-140/77-79	5509+5526	140x90	135-140/87-89	5509+5527
150x80	145-150/77-79	5511+5526	150x90	145-150/87-89	5511+5527
160x80	155-160/77-79	5513+5526	160x90	155-160/87-89	5513+5527
170x80	165-170/77-79	5515+5526	170x90	165-170/87-89	5515+5527
180x80	175-180/77-79	5517+5526	180x90	175-180/87-89	5517+5527

Adorno in alluminio opzionale

0007

Opzione profilo unione fisso + fisso utilizzando l'art. 0182, aumenta la estensibilità di 1,2 cm su uno dei lati. **È necessario laterale fisso su misura.** Si possono combinare frontali di misure intermedie, l'estensibilità non cambia. Le aperture sono le stesse dei frontali.



Guida e supporto fisso in acciaio



Maniglia in metallo



Nuovo cuscin. minimal blindato



Dettaglio unione con lat. fisso



Laterali fissi su misura (maggiori informazioni a pagina 282)

Descrizione	Articoli	Taglio
Laterale fisso su misura VITRO fino 40 cm	1351	
Laterale fisso su misura VITRO da 40 fino 80 cm	1352	
Laterale fisso su misura VITRO da 80 fino 120 cm	1353	

*Tempo di consegna 3 settimane

VITRO frontali + fisso in linea



Descrizione	Cm	Estensibilità	Articoli
VITRO 100+ FISSO 20	120	113-120	5001+5534+1200+1213
VITRO 105+ FISSO 20	125	117-125	5002+5534+1200+1213
VITRO 110+ FISSO 20	130	123-130	5003+5534+1200+1213
VITRO 115+ FISSO 20	135	128-135	5004+5534+1200+1213
VITRO 120+ FISSO 20	140	133-140	5005+5534+1200+1213
VITRO 125+ FISSO 20	145	138-145	5006+5538+1200+1213
VITRO 130+ FISSO 20	150	143-150	5007+5538+1200+1213
VITRO 135+ FISSO 20	155	147-155	5008+5538+1200+1213
VITRO 140+ FISSO 20	160	152-160	5009+5538+1200+1213
VITRO 145+ FISSO 20	165	157-165	5010+5538+1200+1213
VITRO 150+ FISSO 20	170	162-170	5011+5538+1200+1213
VITRO 155+ FISSO 20	175	167-175	5012+5538+1200+1213
VITRO 160+ FISSO 20	180	172-180	5013+5538+1200+1213



Descrizione	Cm	Estensibilità	Articoli
VITRO 100+ FISSO 25	125	117-125	5001+5534+1201+1213
VITRO 105+ FISSO 25	130	123-130	5002+5534+1201+1213
VITRO 110+ FISSO 25	135	128-135	5003+5534+1201+1213
VITRO 115+ FISSO 25	140	133-140	5004+5534+1201+1213
VITRO 120+ FISSO 25	145	138-145	5005+5538+1201+1213
VITRO 125+ FISSO 25	150	143-150	5006+5538+1201+1213
VITRO 130+ FISSO 25	155	147-155	5007+5538+1201+1213
VITRO 135+ FISSO 25	160	152-160	5008+5538+1201+1213
VITRO 140+ FISSO 25	165	157-165	5009+5538+1201+1213
VITRO 145+ FISSO 25	170	162-170	5010+5538+1201+1213
VITRO 150+ FISSO 25	175	167-175	5011+5538+1201+1213
VITRO 155+ FISSO 25	180	172-180	5012+5538+1201+1213
VITRO 100+ FISSO 30	130	123-130	5001+5534+1202+1213
VITRO 105+ FISSO 30	135	128-135	5002+5534+1202+1213
VITRO 110+ FISSO 30	140	133-140	5003+5534+1202+1213
VITRO 115+ FISSO 30	145	138-145	5004+5538+1202+1213
VITRO 120+ FISSO 30	150	143-150	5005+5538+1202+1213
VITRO 125+ FISSO 30	155	147-155	5006+5538+1202+1213
VITRO 130+ FISSO 30	160	152-160	5007+5538+1202+1213
VITRO 135+ FISSO 30	165	157-165	5008+5538+1202+1213
VITRO 140+ FISSO 30	170	162-170	5009+5538+1202+1213
VITRO 145+ FISSO 30	175	167-175	5010+5538+1202+1213
VITRO 150+ FISSO 30	180	172-180	5011+5538+1202+1213
VITRO 100+ FISSO 40	140	133-140	5001+5534+1203+1213
VITRO 105+ FISSO 40	145	138-145	5002+5538+1203+1213
VITRO 110+ FISSO 40	150	143-150	5003+5538+1203+1213
VITRO 115+ FISSO 40	155	147-155	5004+5538+1203+1213
VITRO 120+ FISSO 40	160	152-160	5005+5538+1203+1213
VITRO 125+ FISSO 40	165	157-165	5006+5538+1203+1213
VITRO 130+ FISSO 40	170	162-170	5007+5538+1203+1213
VITRO 135+ FISSO 40	175	167-175	5008+5538+1203+1213
VITRO 140+ FISSO 40	180	172-180	5009+5538+1203+1213
VITRO 100+ FISSO 50	150	143-150	5001+5538+1204+1213
VITRO 105+ FISSO 50	155	147-155	5002+5538+1204+1213
VITRO 110+ FISSO 50	160	152-160	5003+5538+1204+1213
VITRO 115+ FISSO 50	165	157-165	5004+5538+1204+1213
VITRO 120+ FISSO 50	170	162-170	5005+5538+1204+1213
VITRO 125+ FISSO 50	175	167-175	5006+5538+1204+1213
VITRO 130+ FISSO 50	180	172-180	5007+5538+1204+1213
VITRO 100+ FISSO 60	160	152-160	5001+5538+1205+1213
VITRO 105+ FISSO 60	165	157-165	5002+5538+1205+1213
VITRO 110+ FISSO 60	170	162-170	5003+5538+1205+1213
VITRO 115+ FISSO 60	175	167-175	5004+5538+1205+1213
VITRO 120+ FISSO 60	180	172-180	5005+5538+1205+1213

Opzione profilo unione fisso + fisso usando art. 0182 , aumenta l'estensibilità 1,2 cm in uno dei lati. È necessario laterale fisso su misura.

prestige

"Affidabilità e prestazioni
al miglior prezzo".





PRESTIGE semicircolare



Maniglia in metallo



Doppio cuscinetto rinforzato



Pulsante liberatore

Descrizione	Estensibilità	Apertura	Art.
80x80 RAGGIO ITALIANO R55	76,5-79,5	46	0011
90x90 RAGGIO ITALIANO R55	86,5-89,5	52	0013
80x80 RAGGIO ROCA R50	76,5-79,5	46	0046
90x90 RAGGIO ROCA R50	86,5-89,5	52	0047
Profilo espansione +2 cm			0218
Profilo espansione +4 cm			0029

PRESTIGE FROST PLUS semicircolare



Descrizione	Estensibilità	Apertura	Art.	
80x80 RAGGIO ITALIANO R55	76,5-79,5	46	0052	
90x90 RAGGIO ITALIANO R55	86,5-89,5	52	0053	
80x80 RAGGIO ROCA R50	76,5-79,5	46	0048	
90x90 RAGGIO ROCA R50	86,5-89,5	52	0049	
Profilo espansione +2 cm			0218	
Profilo espansione +4 cm			0029	

PRESTIGE 1 fisso+1 scorrevole



Descrizione	Estensibilità	Apertura	TRASPARENTE		FROST PLUS	
			Articoli		Articoli	
PRESTIGE 100X195	97-103	38	0200		0272	
PRESTIGE 110X195	107-113	43	0201		0273	
PRESTIGE 120X195	117-123	48	0202		0274	
PRESTIGE 130X195	127-133	53	0203		0275	
PRESTIGE 140X195	137-143	58	0204		0276	
PRESTIGE 150X195	147-153	63	0205		0277	
PRESTIGE 160X195	157-163	58	0206		0278	
PRESTIGE 170X195	167-173	63	0207		0279	
Profilo espansione +2 cm					0218	
Profilo espansione +4 cm					0029	

*Si può abbinare al Laterale Fisso STD (vedi pag. 64), l'estensibilità aumenta di 0,7 e si perde l'espansione nel lato in cui si installa il fisso.

PRESTIGE SPAZIO 2 fissi + 2 scorrevoli



Descrizione	Estensibilità	Apertura	TRASPARENTE		FROST PLUS	
			Articoli		Articoli	
PRESTIGE SPAZIO 140X195	136-142	53	0610		0616	
PRESTIGE SPAZIO 150X195	146-152	58	0611		0617	
PRESTIGE SPAZIO 160X195	156-162	63	0612		0618	
PRESTIGE SPAZIO 170X195	166-172	68	0613		0619	
PRESTIGE SPAZIO 180X195	176-182	73	0614		0620	
PRESTIGE SPAZIO 190X195	186-192	78	0615		0621	

Profilo espansione +2 cm

0218

Profilo espansione +4 cm

0029

*Si può abbinare al Laterale Fisso STD (vedi pag. 64), l'estensibilità aumenta di 0,7 e si perde l'espansione nel lato in cui si installa il fisso.

PRESTIGE apertura angolare



Descrizione	TRASPARENTE		FROST PLUS	
	Art.		Art.	
Lato 70 x195 cm PRESTIGE	0313		0295	
Lato 75 x195 cm PRESTIGE	0375		0294	
Lato 80 x195 cm PRESTIGE	0314		0296	
Lato 90 x195 cm PRESTIGE	0315		0297	
Lato 100 x195 cm PRESTIGE	0316		0298	
Lato 120 x195 cm PRESTIGE	0317		0299	



Cm	Estensibilità	Apert.
70x70	67-70 / 67-70	33
80x70	77-80 / 67-70	37
90x70	87-90 / 67-70	41
100x70	97-100 / 67-70	45
110x70	104-107 / 67-70	47
120x70	117-120 / 67-70	50
130x70	124-127 / 67-70	56
140x70	134-137 / 67-70	60
150x70	144-147 / 67-70	64
160x70	154-157 / 67-70	60
170x70	164-167 / 67-70	64
Cm	Estensibilità	Apert.
70x75	67-70 / 72-74	35
75x75	72-74 / 72-74	37
80x75	77-80 / 72-74	39
90x75	87-90 / 72-74	42
100x75	97-100 / 72-74	47
110x75	104-107 / 72-74	49
120x75	117-120 / 72-74	52
130x75	124-127 / 72-74	58
140x75	134-137 / 72-74	62
150x75	144-147 / 72-74	66
160x75	154-157 / 72-74	62
170x75	164-167 / 72-74	66
Cm	Estensibilità	Apert.
80x80	77-80 / 77-80	40
90x80	87-90 / 77-80	44
100x80	97-100 / 77-80	48
110x80	104-107 / 77-80	50
120x80	117-120 / 77-80	52
130x80	124-127 / 77-80	58
140x80	134-137 / 77-80	62
150x80	144-147 / 77-80	66
160x80	154-157 / 77-80	62
170x80	164-167 / 77-80	66
Cm	Estensibilità	Apert.
90x90	87-90 / 87-90	47
100x90	97-100 / 87-90	51
110x90	104-107 / 87-90	53
120x90	117-120 / 87-90	55
130x90	124-127 / 87-90	60
140x90	134-137 / 87-90	64
150x90	144-147 / 87-90	68
160x90	154-157 / 87-90	64
170x90	164-167 / 87-90	68

TRASPARENTE	
Articoli	
0313 + 0313	
0314 + 0313	
0315 + 0313	
0316 + 0313	
0201 + 0313	
0317 + 0313	
0203 + 0313	
0204 + 0313	
0205 + 0313	
0206 + 0313	
0207 + 0313	
Articoli	
0313 + 0375	
0375 + 0375	
0314 + 0375	
0315 + 0375	
0316 + 0375	
0201 + 0375	
0317 + 0375	
0203 + 0375	
0204 + 0375	
0205 + 0375	
0206 + 0375	
0207 + 0375	
Articoli	
0314 + 0314	
0315 + 0314	
0316 + 0314	
0201 + 0314	
0317 + 0314	
0203 + 0314	
0204 + 0314	
0205 + 0314	
0206 + 0314	
0207 + 0314	
Articoli	
0315 + 0315	
0316 + 0315	
0201 + 0315	
0317 + 0315	
0203 + 0315	
0204 + 0315	
0205 + 0315	
0206 + 0315	
0207 + 0315	

FROST PLUS	
Articoli	
0295 + 0295	
0296 + 0295	
0297 + 0295	
0298 + 0295	
0273 + 0295	
0299 + 0295	
0275 + 0295	
0276 + 0295	
0277 + 0295	
0278 + 0295	
0279 + 0295	
Articoli	
0295 + 0294	
0294 + 0294	
0296 + 0294	
0297 + 0294	
0298 + 0294	
0273 + 0294	
0299 + 0294	
0275 + 0294	
0276 + 0294	
0277 + 0294	
0278 + 0294	
0279 + 0294	
Articoli	
0296 + 0296	
0297 + 0296	
0298 + 0296	
0273 + 0296	
0299 + 0296	
0275 + 0296	
0276 + 0296	
0277 + 0296	
0278 + 0296	
0279 + 0296	
Articoli	
0297 + 0297	
0298 + 0297	
0273 + 0297	
0299 + 0297	
0275 + 0297	
0276 + 0297	
0277 + 0297	
0278 + 0297	
0279 + 0297	

Si possono anche ottenere abbinamenti con lati 100 e 120

Descrizione	Articoli
Profilo espansione +2 cm	0218
Profilo espansione +4 cm	0029

PRESTIGE frontale + laterale fisso 8 mm



Descrizione	Estensibilità (min-max)	Articoli	
Laterale fisso STD 8 mm 30x195	26-29	0810	
Laterale fisso STD 8 mm 40x195	36-39	0811	
Laterale fisso STD 8 mm 50x195	46-49	0812	
Laterale fisso STD 8 mm 60x195	56-59	0813	
Laterale fisso STD 8 mm 70x195	66-69	0814	
Laterale fisso STD 8 mm 75x195	71-74	0820	
Laterale fisso STD 8 mm 80x195	76-79	0815	
Laterale fisso STD 8 mm 90x195	86-89	0816	
Laterale fisso STD 8 mm FROST PLUS 70	66-69	0817	
Laterale fisso STD 8 mm FROST PLUS 80	76-79	0818	
Laterale fisso STD 8 mm FROST PLUS 90	86-89	0819	



PRESTIGE + laterale fisso 8 mm



Chiusura con magneti occulto



Doppio cuscinetto rinforzato



Pulsante liberatore

Cm	Estensibilità	Apert.	TRASPARENTE		FROST PLUS	
			Articoli		Articoli	
100x70	97,4-100,4 / 66-69	38	0200 + 0814		0272 + 0817	
110x70	107,4-110,4 / 66-69	43	0201 + 0814		0273 + 0817	
120x70	117,4-120,4 / 66-69	48	0202 + 0814		0274 + 0817	
130x70	127,4-130,4 / 66-69	53	0203 + 0814		0275 + 0817	
140x70	137,4-140,4 / 66-69	58	0204 + 0814		0276 + 0817	
150x70	147,4-150,4 / 66-69	53	0205 + 0814		0277 + 0817	
160x70	157,4-160,4 / 66-69	58	0206 + 0814		0278 + 0817	
170x70	167,4-170,4 / 66-69	63	0207 + 0814		0279 + 0817	
Cm	Estensibilità	Apert.	Articoli		Articoli	
100x80	97,4-100,4 / 76-79	38	0200 + 0815		0272 + 0818	
110x80	107,4-110,4 / 76-79	43	0201 + 0815		0273 + 0818	
120x80	117,4-120,4 / 76-79	48	0202 + 0815		0274 + 0818	
130x80	127,4-130,4 / 76-79	53	0203 + 0815		0275 + 0818	
140x80	137,4-140,4 / 76-79	58	0204 + 0815		0276 + 0818	
150x80	147,4-150,4 / 76-79	53	0205 + 0815		0277 + 0818	
160x80	157,4-160,4 / 76-79	58	0206 + 0815		0278 + 0818	
170x80	167,4-170,4 / 76-79	63	0207 + 0815		0279 + 0818	
Cm	Estensibilità	Apert.	Articoli		Articoli	
100x90	97,4-100,4 / 86-89	38	0200 + 0816		0272 + 0819	
110x90	107,4-110,4 / 86-89	43	0201 + 0816		0273 + 0819	
120x90	117,4-120,4 / 86-89	48	0202 + 0816		0274 + 0819	
130x90	127,4-130,4 / 86-89	53	0203 + 0816		0275 + 0819	
140x90	137,4-140,4 / 86-89	58	0204 + 0816		0276 + 0819	
150x90	147,4-150,4 / 86-89	53	0205 + 0816		0277 + 0819	
160x90	157,4-160,4 / 86-89	58	0206 + 0816		0278 + 0819	
170x90	167,4-170,4 / 86-89	63	0207 + 0816		0279 + 0819	

*Si possono abbinare misure intermedie di frontali.

Descrizione	Articoli
Profilo espansione +2 cm	0218
Profilo espansione +4 cm	0029
Profilo espansione (+ 5,5 cm)	0219



Descrizione	TRASPARENTE		FROST PLUS		Taglio
	Art.	P	Art.	P	
Lat. fisso su misura fino 40 cm	1343		1343+1312		
Lat. fisso su misura da 40 fino 80 cm	1304		1304+1313		
Lat. fisso su misura da 80 fino 120 cm	1310		1310+1315		

*Tempo di consegna 3 settimane (maggiori informazioni a pagina 282)

aktual

"Evoluzione e prestazioni
Prestige senza guida
inferiore"





AKTUAL 1 fisso+1 scorrevole



Descrizione	Estensibilità	Apertura	TRASPARENTE		FROST PLUS	
			Articoli		Articoli	
AKTUAL 100X195	97-103	38	0280		0580	
AKTUAL 110X195	107-113	43	0281		0581	
AKTUAL 120X195	117-123	48	0282		0582	
AKTUAL 130X195	127-133	53	0283		0583	
AKTUAL 140X195	137-143	58	0284		0584	
AKTUAL 150X195	147-153	63	0285		0585	
AKTUAL 160X195	157-163	58	0286		0586	
AKTUAL 170X195	167-173	63	0287		0587	
Profilo espansione +2 cm					0218	
Profilo espansione +4 cm					0029	

*Si può abbinare al Laterale Fisso STD (vedi pag. 72), l'estensibilità aumenta di 0,7 e si perde l'espansione nel lato in cui si installa il fisso.

AKTUAL SPAZIO 2 fissi+2 scorrevoli



Descrizione	Estensibilità	Apertura	TRASPARENTE		FROST PLUS	
			Articoli		Articoli	
AKTUAL SPAZIO 140X195	136-142	53	0570		0588	
AKTUAL SPAZIO 150X195	146-152	58	0571		0589	
AKTUAL SPAZIO 160X195	156-162	63	0572		0590	
AKTUAL SPAZIO 170X195	166-172	68	0573		0591	
AKTUAL SPAZIO 180X195	176-182	73	0574		0592	
AKTUAL SPAZIO 190X195	186-192	78	0575		0593	
Profilo espansione +2 cm					0218	
Profilo espansione +4 cm					0029	

*Si può abbinare al Laterale Fisso STD (vedi pag. 72), l'estensibilità aumenta di 0,7 e si perde l'espansione nel lato in cui si installa il fisso.

AKTUAL apertura angolare



Descrizione	TRASPARENTE		FROST PLUS	
	Art.		Art.	
Lato 70x195 AKTUAL 1 fisso+1 scorrevole	0320		0595	
Lato 80x195 AKTUAL 1 fisso+1 scorrevole	0321		0596	
Lato 90x195 AKTUAL 1 fisso+1 scorrevole	0322		0597	
Lato 100x195 AKTUAL 1 fisso+1 scorrevole	0323		0598	
Lato 120x195 AKTUAL 1 fisso+1 scorrevole	0324		0599	

**H195**

Altezza

**8/6mm**

Vetro



Scorrevoli

**3cm**

Espandibile



Magnetico



Reversibile

aluminio
AL
aluminiumclear
tinted
glasscombinazioni angolari **AKTUAL** apertura angolare

Maniglia metallica



Doppio cuscinetto anti-ribaltamento



Profilo salva goccia metallico

Cm	Estensibilità	Apert.
70x70	67-70 / 67-70	33
80x70	77-80 / 67-70	37
90x70	87-90 / 67-70	41
100x70	97-100 / 67-70	45
110x70	104-107 / 67-70	47
120x70	117-120 / 67-70	50
130x70	124-127 / 67-70	56
140x70	134-137 / 67-70	60
150x70	144-147 / 67-70	64

Cm	Estensibilità	Apert.
80x80	77-80 / 77-80	40
90x80	87-90 / 77-80	44
100x80	97-100 / 77-80	48
110x80	104-107 / 77-80	50
120x80	117-120 / 77-80	52
130x80	124-127 / 77-80	58
140x80	134-137 / 77-80	62
150x80	144-147 / 77-80	66

Cm	Estensibilità	Apert.
90x90	87-90 / 87-90	47
100x90	97-100 / 87-90	51
110x90	104-107 / 87-90	53
120x90	117-120 / 87-90	55
130x90	124-127 / 87-90	60
140x90	134-137 / 87-90	64
150x90	144-147 / 87-90	68

TRASPARENTE		FROST PLUS	
Articoli		Articoli	
0320 + 0320		0595 + 0595	
0321 + 0320		0596 + 0595	
0322 + 0320		0597 + 0595	
0323 + 0320		0598 + 0595	
0281 + 0320		0581 + 0595	
0324 + 0320		0599 + 0595	
0283 + 0320		0583 + 0595	
0284 + 0320		0584 + 0595	
0285 + 0320		0585 + 0595	
0321 + 0321		0596 + 0596	
0322 + 0321		0597 + 0596	
0323 + 0321		0598 + 0596	
0281 + 0321		0581 + 0596	
0324 + 0321		0599 + 0596	
0283 + 0321		0583 + 0596	
0284 + 0321		0584 + 0596	
0285 + 0321		0585 + 0596	
0322 + 0322		0597 + 0597	
0323 + 0322		0598 + 0597	
0281 + 0322		0581 + 0597	
0324 + 0322		0599 + 0597	
0283 + 0322		0583 + 0597	
0284 + 0322		0584 + 0597	
0285 + 0322		0585 + 0597	

Si possono anche ottenere abbinamenti con lati 100 e 120

Descrizione	Descrizione
Profilo espansione +2 cm	0218
Profilo espansione +4 cm	0029

AKTUAL frontale + laterale fisso STD 8 mm



Descrizione	Estensibilità (min-max)	Articolo	
Laterale fisso STD 8 mm 30	26-29	0810	
Laterale fisso STD 8 mm 40	36-39	0811	
Laterale fisso STD 8 mm 50	46-49	0812	
Laterale fisso STD 8 mm 60	56-59	0813	
Laterale fisso STD 8 mm 70	66-69	0814	
Laterale fisso STD 8 mm 75	71-74	0820	
Laterale fisso STD 8 mm 80	76-79	0815	
Laterale fisso STD 8 mm 90	86-89	0816	
Laterale fisso STD 8 mm FROST PLUS 70	66-69	0817	
Laterale fisso STD 8 mm FROST PLUS 80	76-79	0818	
Laterale fisso STD 8 mm FROST PLUS 90	86-89	0819	

**H195**

Altezza

**8/6mm**

Vetro



Scorrevoli

**3cm**

Espandibile



Magnetico



Reversibile

aluminio
AL
aluminiumclear
shield
glass

AKTUAL + laterale fisso 8 mm

Chiusura con magnete
occultoDoppio cuscinetto
anti-ribaltamentoProfilo salva goccia
metallico

Cm	Estensibilità	Apert.
100x70	97,4-100,4 / 66-69	38
110x70	107,4-110,4 / 66-69	43
120x70	117,4-120,4 / 66-69	48
130x70	127,4-130,4 / 66-69	53
140x70	137,4-140,4 / 66-69	58
150x70	147,4-150,4 / 66-69	53
160x70	157,4-160,4 / 66-69	58
170x70	167,4-170,4 / 66-69	63
Cm	Estensibilità	Apert.
100x80	97,4-100,4 / 76-79	38
110x80	107,4-110,4 / 76-79	43
120x80	117,4-120,4 / 76-79	48
130x80	127,4-130,4 / 76-79	53
140x80	137,4-140,4 / 76-79	58
150x80	147,4-150,4 / 76-79	53
160x80	157,4-160,4 / 76-79	58
170x80	167,4-170,4 / 76-79	63
Cm	Estensibilità	Apert.
100x90	97,4-100,4 / 86-89	38
110x90	107,4-110,4 / 86-89	43
120x90	117,4-120,4 / 86-89	48
130x90	127,4-130,4 / 86-89	53
140x90	137,4-140,4 / 86-89	58
150x90	147,4-150,4 / 86-89	53
160x90	157,4-160,4 / 86-89	58
170x90	167,4-170,4 / 86-89	63

TRASPARENTE		FROST PLUS	
Articoli		Articoli	
0280 + 0814		0580 + 0817	
0281 + 0814		0581 + 0817	
0282 + 0814		0582 + 0817	
0283 + 0814		0583 + 0817	
0284 + 0814		0584 + 0817	
0285 + 0814		0585 + 0817	
0286 + 0814		0586 + 0817	
0287 + 0814		0587 + 0817	
Articoli		Articoli	
0280 + 0815		0580 + 0818	
0281 + 0815		0581 + 0818	
0282 + 0815		0582 + 0818	
0283 + 0815		0583 + 0818	
0284 + 0815		0584 + 0818	
0285 + 0815		0585 + 0818	
0286 + 0815		0586 + 0818	
0287 + 0815		0587 + 0818	
Articoli		Articoli	
0280 + 0816		0580 + 0819	
0281 + 0816		0581 + 0819	
0282 + 0816		0582 + 0819	
0283 + 0816		0583 + 0819	
0284 + 0816		0584 + 0819	
0285 + 0816		0585 + 0819	
0286 + 0816		0586 + 0819	
0287 + 0816		0587 + 0819	

*Si possono abbinare misure intermedie di frontali.

Descrizione	Articoli
Profilo espansione +2 cm	0218
Profilo espansione +4 cm	0029
Profilo espansione (+ 5,5 cm)	0219



Descrizione	TRASPARENTE		FROST PLUS		Taglio
	Art.		Art.		
Laterali fissi su misura AKTUAL					
Lat. fisso su misura fino 40 cm	1343		1343+1312		
Lat. fisso su misura da 40 fino 80 cm	1304		1304+1313		
Lat. fisso su misura da 80 fino 120 cm	1310		1310+1315		

*Tempo di consegna 3 settimane. Más información en página 282.



TWENTY GOLD pg.76



TWENTY BLACK pg.84



BASIC TITANIO pg.92



BASIC BLACK pg.92



BASIC WHITE pg.92



BOX DOCCIA COLORE SCORREVOLE IN ALLUMINIO

TWENTY GOLD 1 fisso+1 scorrevole
Oro spazzolato





Frontali **TWENTY GOLD** 1 fisso + 1 scorrevole

Cm	Apertura	Art.	
115-120	46-51	2000+2044	
120-125	49-54	2001+2044	
125-130	51-56	2002+2044	
130-135	54-59	2003+2044	
135-140	56-61	2004+2044	
140-145	59-64	2005+2044	
145-150	61-66	2006+2044	
150-155	64-69	2007+2045	
155-160	66-71	2008+2045	
160-165	69-74	2009+2045	
165-170	71-76	2010+2045	
170-175	74-79	2011+2045	
175-180	76-81	2012+2045	



Guida sganciabile



Cuscinetto occulto



Doppia maniglia metallica



Chiusura/apertura soft close



	TRASPARENTE	FROST PLUS PARSOL / OPACO
Box doccia su misura e cristalli speciali		

*Tempo di consegna 3 settimane (maggiori informazioni a pag. 280)

TWENTY SPAZIO GOLD 2 fissi+2 scorrevoli

Oro spazzolato



Box doccia su misura e cristalli speciali

TRASPARENTE

FROST PLUS
PARSOL / OPACO

TAGLIO

*Tempo di consegna 3 settimane (maggiori informazioni a pag. 280)



TWENTY SPAZIO GOLD 2 fissi + 2 scorrevoli

Descrizione	Estensibilità	Apertura	Art.
TWENTY SPAZIO GOLD 140	131-141	44-54	2031+2031+2047
TWENTY SPAZIO GOLD 150	141-151	49-59	2032+2032+2047
TWENTY SPAZIO GOLD 160	151-161	54-64	2033+2033+2047
TWENTY SPAZIO GOLD 170	161-171	59-69	2034+2034+2047
TWENTY SPAZIO GOLD 180	171-181	64-74	2035+2035+2047
TWENTY SPAZIO GOLD 190	181-191	69-79	2036+2036+2047

*Permette laterale fisso in entrambi i lati



Innovativo sistema antiribaltamento



Cuscinetto occulto



Doppia maniglia metallica



Apertura soft close

TWENTY GOLD apertura angolare

Oro spazzolato



	TRASPARENTE	FROST PLUS PARSOL / OPACO	TAGLIO
Box doccia su misura e cristalli speciali			

*Tempo di consegna 3 settimane (maggiori informazioni a pag. 280)



Combinazioni TWENTY GOLD apertura angolare

Cm	Estensibilità	Apertura	Articoli
70X70	65-70/65-70	30-35	2030+2030+2046
75X70	70-75/65-70	32-37	2031+2030+2046
80X70	75-80/65-70	34-39	2032+2030+2046
85X70	80-85/65-70	36-41	2033+2030+2046
90X70	85-90/65-70	38-43	2034+2030+2046
95X70	90-95/65-70	40-45	2035+2030+2046
100X70	95-100/65-70	42-47	2036+2030+2046
120X70	115-120/65-70	52-57	2037+2030+2046
Cm	Estensibilità	Apertura	Articoli
75X75	70-75/70-75	34-39	2031+2031+2046
80X75	75-80/70-75	36-41	2032+2031+2046
85X75	80-85/70-75	38-43	2033+2031+2046
90X75	85-90/70-75	40-45	2034+2031+2046
95X75	90-95/70-75	42-47	2035+2031+2046
100X75	95-100/70-75	45-50	2036+2031+2046
120X75	115-120/70-75	54-59	2037+2031+2046
Cm	Estensibilità	Apertura	Articoli
80X80	75-80/75-80	38-43	2032+2032+2046
85X80	80-85/75-80	40-45	2033+2032+2046
90X80	85-90/75-80	42-47	2034+2032+2046
95X80	90-95/75-80	45-50	2035+2032+2046
100X80	95-100/75-80	47-52	2036+2032+2046
120X80	115-120/75-80	56-61	2037+2032+2046
Cm	Estensibilità	Apertura	Articoli
90X90	85-90/85-90	47-52	2034+2034+2046
95X90	90-95/85-90	49-54	2035+2034+2046
100X90	95-100/85-90	50-55	2036+2034+2046
120X90	115-120/85-90	60-65	2037+2034+2046



Innovativo sistema antiribaltamento



Cuscinetto occulto



Doppia maniglia metallica



Apertura soft close

TWENTY GOLD frontale + lat. fisso

Oro spazzolato



Descrizione	Estensibilità	Art.	
Laterale fisso TWENTY GOLD 70	66,5-69,5	2048	
Laterale fisso TWENTY GOLD 75	71,5-74,5	2049	
Laterale fisso TWENTY GOLD 80	76,5-79,5	2050	
Laterale fisso TWENTY GOLD 90	86,5-89,5	2051	



Laterali fissi su misura (maggiori informazioni a pagina 282)

Descrizione	Articoli		Taglio
Lat. fisso su misura TWENTY fino 40 cm	1375OR		
Lat. fisso su misura TWENTY da 40 fino 80 cm	1376OR		
Lat. fisso su misura TWENTY da 80 fino 120 cm	1377OR		

*Tempo di consegna 3 settimane



Combinazioni frontali **TWENTY GOLD** + laterale fisso 6 mm

Cm	Estensibilità	Articoli	Cm	Estensibilità	Articoli
120X70	115-120/66,5-69,5	2000+2044+2048	120X75	115-120/71,5-74,5	2000+2044+2049
125X70	120-125/66,5-69,5	2001+2044+2048	125X75	120-125/71,5-74,5	2001+2044+2049
130X70	125-130/66,5-69,5	2002+2044+2048	130X75	125-130/71,5-74,5	2002+2044+2049
135X70	130-135/66,5-69,5	2003+2044+2048	135X75	130-135/71,5-74,5	2003+2044+2049
140X70	135-140/66,5-69,5	2004+2044+2048	140X75	135-140/71,5-74,5	2004+2044+2049
145X70	140-145/66,5-69,5	2005+2044+2048	145X75	140-145/71,5-74,5	2005+2044+2049
150X70	145-150/66,5-69,5	2006+2044+2048	150X75	145-150/71,5-74,5	2006+2044+2049
155X70	150-155/66,5-69,5	2007+2045+2048	155X75	150-155/71,5-74,5	2007+2045+2049
160X70	155-160/66,5-69,5	2008+2045+2048	160X75	155-160/71,5-74,5	2008+2045+2049
165X70	160-165/66,5-69,5	2009+2045+2048	165X75	160-165/71,5-74,5	2009+2045+2049
170X70	165-170/66,5-69,5	2010+2045+2048	170X75	165-170/71,5-74,5	2010+2045+2049
175X70	170-175/66,5-69,5	2011+2045+2048	175X75	170-175/71,5-74,5	2011+2045+2049
180X70	175-180/66,5-69,5	2012+2045+2048	180X75	175-180/71,5-74,5	2012+2045+2049
Cm	Estensibilità	Articoli	Cm	Estensibilità	Articoli
120X80	115-120/76,5-79,5	2000+2044+2050	120X90	115-120/86,5-89,5	2000+2044+2051
125X80	120-125/76,5-79,5	2001+2044+2050	125X90	120-125/86,5-89,5	2001+2044+2051
130X80	125-130/76,5-79,5	2002+2044+2050	130X90	125-130/86,5-89,5	2002+2044+2051
135X80	130-135/76,5-79,5	2003+2044+2050	135X90	130-135/86,5-89,5	2003+2044+2051
140X80	135-140/76,5-79,5	2004+2044+2050	140X90	135-140/86,5-89,5	2004+2044+2051
145X80	140-145/76,5-79,5	2005+2044+2050	145X90	140-145/86,5-89,5	2005+2044+2051
150X80	145-150/76,5-79,5	2006+2044+2050	150X90	145-150/86,5-89,5	2006+2044+2051
155X80	150-155/76,5-79,5	2007+2045+2050	155X90	150-155/86,5-89,5	2007+2045+2051
160X80	155-160/76,5-79,5	2008+2045+2050	160X90	155-160/86,5-89,5	2008+2045+2051
165X80	160-165/76,5-79,5	2009+2045+2050	165X90	160-165/86,5-89,5	2009+2045+2051
170X80	165-170/76,5-79,5	2010+2045+2050	170X90	165-170/86,5-89,5	2010+2045+2051
175X80	170-175/76,5-79,5	2011+2045+2050	175X90	170-175/86,5-89,5	2011+2045+2051
180X80	175-180/76,5-79,5	2012+2045+2050	180X90	175-180/86,5-89,5	2012+2045+2051

Le aperture sono le stesse dei frontali



Guida sganciabile



Cuscinetto occulto



Doppia maniglia metallica



Chiusura/apertura soft close

TWENTY BLACK 1 fisso+1 scorrevole





Frontali TWENTY BLACK 1 fisso + 1 scorrevole

Cm	Apertura	Art.	
115-120	46-51	2000+2023	
120-125	49-54	2001+2023	
125-130	51-56	2002+2023	
130-135	54-59	2003+2023	
135-140	56-61	2004+2023	
140-145	59-64	2005+2023	
145-150	61-66	2006+2023	
150-155	64-69	2007+2024	
155-160	66-71	2008+2024	
160-165	69-74	2009+2024	
165-170	71-76	2010+2024	
170-175	74-79	2011+2024	
175-180	76-81	2012+2024	



Guida sganciabile



Cuscinetto occulto



Doppia maniglia metallica



Chiusura/apertura soft close



	TRASPARENTE	FROST PLUS PARSOL / OPACO
Box doccia su misura e cristalli speciali		

*Tempo di consegna 3 settimane (maggiori informazioni a pag. 280)

TWENTY SPAZIO BLACK 2 fissi+ 2 scorrevoli



Box doccia su misura e cristalli speciali

TRASPARENTE

FROST PLUS
PARSOL / OPACO

TAGLIO

*Tempo di consegna 3 settimane (maggiori informazioni a pag. 280)



TWENTY SPAZIO BLACK 2 fissi + 2 scorrevoli

Descrizione	Estensibilità	Apertura	Art.
TWENTY SPAZIO BLACK 140	131-141	44-54	2031+2031+2043
TWENTY SPAZIO BLACK 150	141-151	49-59	2032+2032+2043
TWENTY SPAZIO BLACK 160	151-161	54-64	2033+2033+2043
TWENTY SPAZIO BLACK 170	161-171	59-69	2034+2034+2043
TWENTY SPAZIO BLACK 180	171-181	64-74	2035+2035+2043
TWENTY SPAZIO BLACK 190	181-191	69-79	2036+2036+2043

*Permette laterale fisso in entrambi i lati



Innovativo sistema antiribaltamento



Cuscinetto occulto



Doppia maniglia metallica



Apertura soft close

TWENTY BLACK apertura angolare



Box doccia su misura e cristalli speciali

TRASPARENTE

FROST PLUS
PARSOL / OPACO

TAGLIO

*Tempo di consegna 3 settimane (maggiori informazioni a pag. 280)



Combinazioni TWENTY BLACK apertura angolare

Cm	Estensibilità	Apertura	Articoli
70X70	65-70/65-70	30-35	2030+2030+2039
75X70	70-75/65-70	32-37	2031+2030+2039
80X70	75-80/65-70	34-39	2032+2030+2039
85X70	80-85/65-70	36-41	2033+2030+2039
90X70	85-90/65-70	38-43	2034+2030+2039
95X70	90-95/65-70	40-45	2035+2030+2039
100X70	95-100/65-70	42-47	2036+2030+2039
120X70	115-120/65-70	52-57	2037+2030+2039
Cm	Estensibilità	Apertura	Articoli
75X75	70-75/70-75	34-39	2031+2031+2039
80X75	75-80/70-75	36-41	2032+2031+2039
85X75	80-85/70-75	38-43	2033+2031+2039
90X75	85-90/70-75	40-45	2034+2031+2039
95X75	90-95/70-75	42-47	2035+2031+2039
100X75	95-100/70-75	45-50	2036+2031+2039
120X75	115-120/70-75	54-59	2037+2031+2039
Cm	Estensibilità	Apertura	Articoli
80X80	75-80/75-80	38-43	2032+2032+2039
85X80	80-85/75-80	40-45	2033+2032+2039
90X80	85-90/75-80	42-47	2034+2032+2039
95X80	90-95/75-80	45-50	2035+2032+2039
100X80	95-100/75-80	47-52	2036+2032+2039
120X80	115-120/75-80	56-61	2037+2032+2039
Cm	Estensibilità	Apertura	Articoli
90X90	85-90/85-90	47-52	2034+2034+2039
95X90	90-95/85-90	49-54	2035+2034+2039
100X90	95-100/85-90	50-55	2036+2034+2039
120X90	115-120/85-90	60-65	2037+2034+2039



Innovativo sistema antiribaltamento



Cuscinetto occulto



Doppia maniglia metallica



Apertura soft close

TWENTY BLACK frontale + lat. fisso



Descrizione	Estensibilità	Art.	
Laterale fisso TWENTY BLACK 70	66,5-69,5	2017	
Laterale fisso TWENTY BLACK 75	71,5-74,5	2018	
Laterale fisso TWENTY BLACK 80	76,5-79,5	2019	
Laterale fisso TWENTY BLACK 90	86,5-89,5	2020	



Laterali fissi su misura (maggiori informazioni a pagina 282)

Descrizione	Articoli		Taglio
Lat. fisso su misura TWENTY fino 40 cm	1375N		
Lat. fisso su misura TWENTY da 40 fino 80 cm	1376N		
Lat. fisso su misura TWENTY da 80 fino 120 cm	1377N		

*Tempo di consegna 3 settimane



Combinazioni frontali **TWENTY BLACK** + laterale fisso 6 mm

Cm	Estensibilità	Articoli	Cm	Estensibilità	Articoli
120X70	115-120/66,5-69,5	2000+2023+2017	120X75	115-120/71,5-74,5	2000+2023+2018
125X70	120-125/66,5-69,5	2001+2023+2017	125X75	120-125/71,5-74,5	2001+2023+2018
130X70	125-130/66,5-69,5	2002+2023+2017	130X75	125-130/71,5-74,5	2002+2023+2018
135X70	130-135/66,5-69,5	2003+2023+2017	135X75	130-135/71,5-74,5	2003+2023+2018
140X70	135-140/66,5-69,5	2004+2023+2017	140X75	135-140/71,5-74,5	2004+2023+2018
145X70	140-145/66,5-69,5	2005+2023+2017	145X75	140-145/71,5-74,5	2005+2023+2018
150X70	145-150/66,5-69,5	2006+2023+2017	150X75	145-150/71,5-74,5	2006+2023+2018
155X70	150-155/66,5-69,5	2007+2024+2017	155X75	150-155/71,5-74,5	2007+2024+2018
160X70	155-160/66,5-69,5	2008+2024+2017	160X75	155-160/71,5-74,5	2008+2024+2018
165X70	160-165/66,5-69,5	2009+2024+2017	165X75	160-165/71,5-74,5	2009+2024+2018
170X70	165-170/66,5-69,5	2010+2024+2017	170X75	165-170/71,5-74,5	2010+2024+2018
175X70	170-175/66,5-69,5	2011+2024+2017	175X75	170-175/71,5-74,5	2011+2024+2018
180X70	175-180/66,5-69,5	2012+2024+2017	180X75	175-180/71,5-74,5	2012+2024+2018
Cm	Estensibilità	Articoli	Cm	Estensibilità	Articoli
120X80	115-120/76,5-79,5	2000+2023+2019	120X90	115-120/86,5-89,5	2000+2023+2020
125X80	120-125/76,5-79,5	2001+2023+2019	125X90	120-125/86,5-89,5	2001+2023+2020
130X80	125-130/76,5-79,5	2002+2023+2019	130X90	125-130/86,5-89,5	2002+2023+2020
135X80	130-135/76,5-79,5	2003+2023+2019	135X90	130-135/86,5-89,5	2003+2023+2020
140X80	135-140/76,5-79,5	2004+2023+2019	140X90	135-140/86,5-89,5	2004+2023+2020
145X80	140-145/76,5-79,5	2005+2023+2019	145X90	140-145/86,5-89,5	2005+2023+2020
150X80	145-150/76,5-79,5	2006+2023+2019	150X90	145-150/86,5-89,5	2006+2023+2020
155X80	150-155/76,5-79,5	2007+2024+2019	155X90	150-155/86,5-89,5	2007+2024+2020
160X80	155-160/76,5-79,5	2008+2024+2019	160X90	155-160/86,5-89,5	2008+2024+2020
165X80	160-165/76,5-79,5	2009+2024+2019	165X90	160-165/86,5-89,5	2009+2024+2020
170X80	165-170/76,5-79,5	2010+2024+2019	170X90	165-170/86,5-89,5	2010+2024+2020
175X80	170-175/76,5-79,5	2011+2024+2019	175X90	170-175/86,5-89,5	2011+2024+2020
180X80	175-180/76,5-79,5	2012+2024+2019	180X90	175-180/86,5-89,5	2012+2024+2020

Le aperture sono le stesse dei frontali



Guida sganciabile



Cuscinetto occulto



Doppia maniglia metallica



Chiusura/apertura soft close

BASIC COLORE

FRONTALE PROFILI NERI



Profili con stop. anti-ribaltamento



Doppio cuscinetto di ultima generazione in nylon



Innovativo sistema di guide con pulsante per liberare l'anta



Adorno in alluminio opzionale

FRONTALE PROFILI BIANCHI



FRONTALE PROFILI TITANIO



Opzione maniglia ultrapiatta nera 22x1,6x0,7 cm

Art.	P
9031	38



Estensibilità	Apert.	TRASPARENTE		FROST PLUS	
		NERO	BIANCO	NERO	BIANCO
95-100	36-41	5001+5493	5001+5583	6001+5493	6001+5583
100-105	36-41	5002+5493	5002+5583	6002+5493	6002+5583
105-110	41-46	5003+5493	5003+5583	6003+5493	6003+5583
110-115	41-46	5004+5493	5004+5583	6004+5493	6004+5583
115-120	46-51	5005+5493	5005+5583	6005+5493	6005+5583
120-125	46-51	5006+5493	5006+5583	6006+5493	6006+5583
125-130	51-56	5007+5493	5007+5583	6007+5493	6007+5583
130-135	51-56	5008+5493	5008+5583	6008+5493	6008+5583
135-140	56-61	5009+5493	5009+5583	6009+5493	6009+5583
140-145	56-61	5010+5494	5010+5584	6010+5494	6010+5584
145-150	61-66	5011+5494	5011+5584	6011+5494	6011+5584
150-155	61-66	5012+5494	5012+5584	6012+5494	6012+5584
155-160	61-66	5013+5494	5013+5584	6013+5494	6013+5584
160-165	61-66	5014+5494	5014+5584	6014+5494	6014+5584
165-170	66-71	5015L+5494	5015L+5584	6015L+5494	6015L+5584
170-175	66-71	5016L+5494	5016L+5584	6016L+5494	6016L+5584
175-180	66-71	5017L+5494	5017L+5584	6017L+5494	6017L+5584
180-190	66-71	5023L+5495	5023L+5585	6023L+5495	6023L+5585
190-200	66-71	5024L+5495	5024L+5585	6024L+5495	6024L+5585

Composizione per articoli/prezzo a pagina 293.

Opzione profili +30 p

Descrizione	TITANIO	
	Art.	
Accessori frontali fino 140 cm	5560	
Accessori de 140 cm fino 180 cm	5561	
Accessori de 180 cm fino 200 cm	5562	

Sostituire articolo bianco/nero con articolo titanio

Accessori

Descrizione	NERO		BIANCO		TITANIO	
	Art.		Art.		Art.	
Profilo espansione +1,5 cm	5477		5473		5478	
Adorno in alluminio 195x3,8 cm	0007N		0007B		0007T	



	TRASPARENTE	FROST PLUS PARSOL / OPACO	TAGLIO
Box doccia su misura e cristalli speciali			

*Tempo di consegna 3 settimane (maggiori informazioni a pag. 280)

BASIC SPAZIO COLORE

PROFILI TITANIO



Profili con stop. anti-ribaltamento



Doppio cuscinetto di ultima generazione in nylon



Innovativo sistema di guide con pulsante per liberare l'anta

FRONTALE PROFILI BIANCHI



FRONTALE PROFILI NERI



Opzione maniglia ultrapiatta nera 22x1,6x0,7 cm

Art.	
9031	



Estensibilità	Apert.	TRASPARENTE		FROST PLUS	
		NERO	BIANCO	NERO	BIANCO
132-142	46-56	5029+5029+5496	5029+5029+5586	6029+6029+5496	6029+6029+5586
142-152	56-66	5019+5019+5496	5019+5019+5586	6019+6019+5496	6019+6019+5586
152-162	54-64	5030+5030+5496	5030+5030+5586	6030+6030+5496	6030+6030+5586
162-172	66-76	5020+5020+5496	5020+5020+5586	6020+6020+5496	6020+6020+5586
172-182	62-72	5031+5031+5497	5031+5031+5587	6031+6031+5497	6031+6031+5587
182-192	76-86	5021+5021+5497	5021+5021+5587	6021+6021+5497	6021+6021+5587
190-200	76-86	5001+5001+5497	5001+5001+5587	6001+6001+5497	6001+6001+5587
200-210	76-86	5002+5002+5497	5002+5002+5587	6002+6002+5497	6002+6002+5587

Composizione per articoli/prezzo a pagina 293.

Opzione profili +30 p

Descrizione	TITANIO	
	Art.	
Accessori frontali fino 172 cm	5565	
Accessori de 172 cm fino 210 cm	5566	

Sostituire articolo bianco/nero con articolo titanio

Accessori

Descrizione	NERO		BIANCO		TITANIO	
	Art.		Art.		Art.	
Profilo espansione +1,5 cm	5477		5473		5478	
Adorno in alluminio 195x3,8 cm	0007N		0007B		0007T	
Profilo di unione fisso-fisso (indicare il verso)	0991		0182B			



	TRASPARENTE	FROST PLUS PARSOL / OPACO	TAGLIO
Box doccia su misura e cristalli speciali			

*Tempo di consegna 3 settimane (maggiori informazioni a pag. 280)

BASIC COLORE apertura angolare

PROFILI NERI



Profili con stop. anti-ribaltamento



Doppio cuscinetto di ultima generazione in nylon



Innovativo sistema di guide con pulsante per liberare l'anta

FRONTALE PROFILI BIANCHI



FRONTALE PROFILI TITANIO



Opzione maniglia ultrapiatta nera 22x1,6x0,7 cm

Art.	
9031	

Cm	Estensibilità	TRASPARENTE		FROST PLUS	
		NERO	BIANCO	NERO	BIANCO
Combinazioni c/LATI 70 fisso+scorrevole					
70x70	65-70/65-70	5018+5018+5490	5018+5018+5580	6018+6018+5490	6018+6018+5580
75x70	70-75/65-70	5029+5018+5490	5029+5018+5580	6029+6018+5490	6029+6018+5580
80x70	75-80/65-70	5019+5018+5490	5019+5018+5580	6019+6018+5490	6019+6018+5580
85x70	80-85/65-70	5030+5018+5490	5030+5018+5580	6030+6018+5490	6030+6018+5580
90x70	85-90/65-70	5020+5018+5490	5020+5018+5580	6020+6018+5490	6020+6018+5580
95x70	90-95/65-70	5031+5018+5490	5031+5018+5580	6031+6018+5490	6031+6018+5580
100x70	95-100/65-70	5021+5018+5490	5021+5018+5580	6021+6018+5490	6021+6018+5580
110x70	105-109/65-70	5002+5018+5490	5002+5018+5580	6002+6018+5490	6002+6018+5580
120x70	115-120/65-70	5022+5018+5490	5022+5018+5580	6022+6018+5490	6022+6018+5580
130x70	125-129/65-70	5006+5018+5491	5006+5018+5581	6006+6018+5491	6006+6018+5581
140x70	135-139/65-70	5008+5018+5491	5008+5018+5581	6008+6018+5491	6008+6018+5581
Combinazioni c/LATI 75 fisso+scorrevole					
75x75	70-75/70-75	5029+5029+5490	5029+5029+5580	6029+6029+5490	6029+6029+5580
80x75	75-80/70-75	5019+5029+5490	5019+5029+5580	6019+6029+5490	6019+6029+5580
85x75	80-85/70-75	5030+5029+5490	5030+5029+5580	6030+6029+5490	6030+6029+5580
90x75	85-90/70-75	5020+5029+5490	5020+5029+5580	6020+6029+5490	6020+6029+5580
95x75	90-95/70-75	5031+5029+5490	5031+5029+5580	6031+6029+5490	6031+6029+5580
100x75	95-100/70-75	5021+5029+5490	5021+5029+5580	6021+6029+5490	6021+6029+5580
100x75	105-109/70-75	5002+5029+5490	5002+5029+5580	6002+6029+5490	6002+6029+5580
120x75	115-120/70-75	5022+5029+5490	5022+5029+5580	6022+6029+5490	6022+6029+5580
130x75	125-129/70-75	5006+5029+5491	5006+5029+5581	6006+6029+5491	6006+6029+5581
140x75	135-139/70-75	5008+5029+5491	5008+5029+5581	6008+6029+5491	6008+6029+5581
Combinazioni c/LATI 80 fisso+scorrevole					
80x80	75-80/75-80	5019+5019+5490	5019+5019+5580	6019+6019+5490	6019+6019+5580
85x80	80-85/75-80	5030+5019+5490	5030+5019+5580	6030+6019+5490	6030+6019+5580
90x80	85-90/75-80	5020+5019+5490	5020+5019+5580	6020+6019+5490	6020+6019+5580
95x80	90-95/75-80	5031+5019+5490	5031+5019+5580	6031+6019+5490	6031+6019+5580
100x80	95-100/75-80	5021+5019+5490	5021+5019+5580	6021+6019+5490	6021+6019+5580
110x80	105-109/75-80	5002+5019+5490	5002+5019+5580	6002+6019+5490	6002+6019+5580
120x80	115-120/75-80	5022+5019+5490	5022+5019+5580	6022+6019+5490	6022+6019+5580
130x80	125-129/75-80	5006+5019+5491	5006+5019+5581	6006+6019+5491	6006+6019+5581
140x80	135-139/75-80	5008+5019+5491	5008+5019+5581	6008+6019+5491	6008+6019+5581
Combinazioni c/LATI 90 fisso+scorrevole					
90x90	85-90/85-90	5020+5020+5490	5020+5020+5580	6020+6020+5490	6020+6020+5580
95x90	90-95/85-90	5031+5020+5490	5031+5020+5580	6031+6020+5490	6031+6020+5580
100x90	95-100/85-90	5021+5020+5490	5021+5020+5580	6021+6020+5490	6021+6020+5580
110x90	105-109/85-90	5002+5020+5490	5002+5020+5580	6002+6020+5490	6002+6020+5580
120x90	115-120/85-90	5022+5020+5490	5022+5020+5580	6022+6020+5490	6022+6020+5580
130x90	125-129/85-90	5006+5020+5491	5006+5020+5581	6006+6020+5491	6006+6020+5581
140x90	135-139/85-90	5008+5020+5491	5008+5020+5581	6008+6020+5491	6008+6020+5581

Composizione per articoli/prezzo a pagina 293. Aperture vedi pagina 29.

Opzione profili +30 p

Descrizione	TITANIO	
	Art.	
Accessori fino 120x90 cm	5563	
Accessori fino 140x100 cm	5564	

Sostituire articolo bianco/nero con articolo titanio

BASIC COLORE con laterale fisso

PROFILINERI



FRONTALE PROFILI BIANCHI



FRONTALE PROFILI TITANIO



Frontali e lat. fissi
su misura
(vedi pag. 280 e 282)

PASSO 1: Selezionare la misura/colore dei PROFILI

PASSO 2: Selezionare la misura/finitura dei FRONTALI+LAT. FISSO

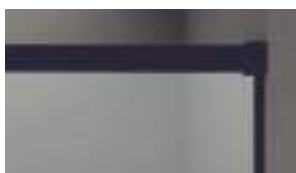

PASSO 1: PROFILI

Descrizione

Accessori fino 140 cm

Accessori fino 180 cm

NERO

Art.

5493+5492

5494+5492

BIANCO

Art.

5583+5588

5584+5588

TITANIO

Art.

5560+5567

5561+5567



PASSO 2: FRONTALI+LAT. FISSO

		TRASPARENTE		FROST PLUS	
Cm	Estensibilità (cm)	Art.		Art.	
Combinazioni c/ LATERALE FISSO DA 70					
100x70	Cristalli da 95-100/67-69	5001+5025		6001+6025	
110x70	Cristalli da 105-110/67-69	5003+5025		6003+6025	
120x70	Cristalli da 115-120/67-69	5005+5025		6005+6025	
130x70	Cristalli da 125-130/67-69	5007+5025		6007+6025	
140x70	Cristalli da 135-140/67-69	5009+5025		6009+6025	
150x70	Cristalli da 145-150/67-69	5011+5025		6011+6025	
160x70	Cristalli da 155-160/67-69	5013+5025		6013+6025	
170x70	Cristalli da 165-170/67-69	5015L+5025		6015L+6025	
180x70	Cristalli da 175-180/67-69	5017L+5025		6017L+6025	
Combinazioni c/ LATERALE FISSO DA 75					
100x75	Cristalli da 95-100/72-74	5001+5057		6001+6057	
110x75	Cristalli da 105-110/72-74	5003+5057		6003+6057	
120x75	Cristalli da 115-120/72-74	5005+5057		6005+6057	
130x75	Cristalli da 125-130/72-74	5007+5057		6007+6057	
140x75	Cristalli da 135-140/72-74	5009+5057		6009+6057	
150x75	Cristalli da 145-150/72-74	5011+5057		6011+6057	
160x75	Cristalli da 155-160/72-74	5013+5057		6013+6057	
170x75	Cristalli da 165-170/72-74	5015L+5057		6015L+6057	
180x75	Cristalli da 175-180/72-74	5017L+5057		6017L+6057	
Combinazioni c/ LATERALE FISSO DA 80					
100x80	Cristalli da 95-100/77-79	5001+5026		6001+6026	
110x80	Cristalli da 105-110/77-79	5003+5026		6003+6026	
120x80	Cristalli da 115-120/77-79	5005+5026		6005+6026	
130x80	Cristalli da 125-130/77-79	5007+5026		6007+6026	
140x80	Cristalli da 135-140/77-79	5009+5026		6009+6026	
150x80	Cristalli da 145-150/77-79	5011+5026		6011+6026	
160x80	Cristalli da 155-160/77-79	5013+5026		6013+6026	
170x80	Cristalli da 165-170/77-79	5015L+5026		6015L+6026	
180x80	Cristalli da 175-180/77-79	5017L+5026		6017L+6026	
Combinazioni c/ LATERALE FISSO DA 90					
100x90	Cristalli da 95-100/87-89	5001+5027		6001+6027	
110x90	Cristalli da 105-110/87-89	5003+5027		6003+6027	
120x90	Cristalli da 115-120/87-89	5005+5027		6005+6027	
130x90	Cristalli da 125-130/87-89	5007+5027		6007+6027	
140x90	Cristalli da 135-140/87-89	5009+5027		6009+6027	
150x90	Cristalli da 145-150/87-89	5011+5027		6011+6027	
160x90	Cristalli da 155-160/87-89	5013+5027		6013+6027	
170x90	Cristalli da 165-170/87-89	5015L+5027		6015L+6027	
180x90	Cristalli da 175-180/87-89	5017L+5027		6017L+6027	

*Profilo di unione fisso-fisso NERO art. 0991 (indicare il verso).

*Profilo di unione fisso-fisso BIANCO art. 0182B (indicare il verso).

BASIC FISSO + PORTA + FISSO

PROFILINERI



Profili con stop. anti-ribaltamento



Doppio cuscinetto di ultima generazione in nylon



Innovativo sistema di guide con pulsante per liberare l'anta e facilitarne la pulizia



Frontali su misura (vedi pag. 280)

PROFILI BIANCHI



PROFILI TITANIO



Opzione maniglia ultrapiatta nera 22x1,6x0,7 cm

Art.	
9031	

PASSO 1: Selezionare la misura/colore dei PROFILI

PASSO 2: Selezionare la misura/finitura FISSO IN LINEA

PASSO 3: Selezionare la misura/finitura dei FRONTALI

Estensibilità = Estensibilità Min/Max frontale + misura fisso in linea



PASSO 1: PROFILI

Descrizione	NERO		BIANCO		TITANIO	
	Art.		Art.		Art.	
Accessori frontali fino 140 cm	5493+5467N		5583+5467B		5560+5467T	
Accessori frontali fino 180 cm	5494+5467N		5584+5467B		5561+5467T	
Accessori frontali fino 200 cm	5495+5467N		5585+5467B		5562+5467T	

PASSO 2: FISSO IN LINEA

Cm fisso	TRASPARENTE		FROST PLUS	
	Art.		Art.	
Fisso da 30 cm	5018F		6018F	
Fisso da 35 cm	5019F		6019F	
Fisso da 40 cm	5020F		6020F	
Fisso da 45 cm	5021F		6021F	
Fisso da 52 cm	5002F		6002F	
Fisso da 55 cm	5022F		6022F	
Fisso da 57 cm	5004F		6004F	

PASSO 3: FRONTALI

Descrizione	Estensibilità (cm)	TRASPARENTE		FROST PLUS	
		Art.		Art.	
Fisso + Porta frontale da 100	95-100	5001		6001	
Fisso + Porta frontale da 105	100-105	5002		6002	
Fisso + Porta frontale da 110	105-110	5003		6003	
Fisso + Porta frontale da 115	110-115	5004		6004	
Fisso + Porta frontale da 120	115-120	5005		6005	
Fisso + Porta frontale da 125	120-125	5006		6006	
Fisso + Porta frontale da 130	125-130	5007		6007	
Fisso + Porta frontale da 135	130-135	5008		6008	
Fisso + Porta frontale da 140	135-140	5009		6009	
Fisso + Porta frontale da 145	140-145	5010		6010	
Fisso + Porta frontale da 150	145-150	5011		6011	
Fisso + Porta frontale da 155	150-155	5012		6012	
Fisso + Porta frontale da 160	155-160	5013		6013	
Fisso + Porta frontale da 165	160-165	5014		6014	
Fisso + Porta frontale da 170	165-170	5015L		6015L	
Fisso + Porta frontale da 175	170-175	5016L		6016L	
Fisso + Porta frontale da 180	175-180	5017L		6017L	
Fisso + Porta frontale da 190	180-190	5023L		6023L	
Fisso + Porta frontale da 200	190-200	5024L		6024L	

A misura e speciali, vedi pag. 280.

BASIC FREE COLORE

PROFILI BIANCHI



Profili con stop. anti-ribaltamento



Doppio cuscinetto di ultima generazione in nylon



Innovativo sistema di guide con pulsante per liberare l'anta e facilitarne la pulizia

PROFILI TITANIO



PROFILI NERI



Opzione maniglia ultrapiatta nera 22x1,6x0,7 cm

Art.	
9031	

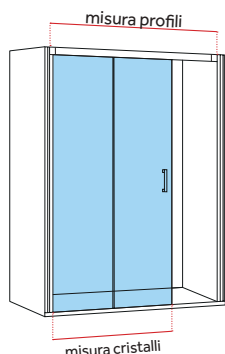

PASSO 1: Selezionare la misura/colore dei PROFILI
PASSO 2: Selezionare la misura/finitura dei CRISTALLI



PASSO 1: PROFILI

Descrizione	NERO		BIANCO		TITANIO	
	Art.		Art.		Art.	
Prof. e acc. fino 140 + KIT FREE	5493+5447N		5583+5447B		5560+5447T	
Prof. e acc. fino 180 + KIT FREE	5494+5447N		5584+5447B		5561+5447T	
Prof. e acc. fino 200 + KIT FREE	5495+5447N		5585+5447B		5562+5447T	

*Composizione per articoli/prezzo a pagina 293.

PASSO 2: CRISTALLI

Estensibilità (cm)	TRASPARENTE		FROST PLUS	
	Art.		Art.	
Cristalli da 95-100	5001		6001	
Cristalli da 100-105	5002		6002	
Cristalli da 105-110	5003		6003	
Cristalli da 110-115	5004		6004	
Cristalli da 115-120	5005		6005	
Cristalli da 120-125	5006		6006	
Cristalli da 125-130	5007		6007	
Cristalli da 130-135	5008		6008	
Cristalli da 135-140	5009		6009	
Cristalli da 140-145	5010		6010	
Cristalli da 145-150	5011		6011	
Cristalli da 150-155	5012		6012	
Cristalli da 155-160	5013		6013	
Cristalli da 160-165	5014		6014	
Cristalli da 165-170	5015L		6015L	
Cristalli da 170-175	5016L		6016L	
Cristalli da 175-180	5017L		6017L	
Cristalli da 180-190	5023L		6023L	
Cristalli da 190-200	5024L		6024L	



Box doccia su misura e cristalli speciali	TRASPARENTE	FROST PLUS PARSOL / OPACO	TAGLIO

*Tempo di consegna 3 settimane (maggiori informazioni a pag. 280)

VETRUM pg.106



TEMPLE pg.118



ROTARY pg.126



FUTURA pg.134



MOVING pg.153



ACCIAIO

**BOX DOCCIA
ACCIAIO
SCORREVOLI**

vetrum

10/8mm

"Design e qualità insuperabili
con totale assenza di profili."





VETRUM

VETRUM 1 fisso + 1 scorrevole





Frontali VETRUM 1 fisso+1 scorrevole

Descrizione	Estensibilità	Apertura	Articoli
Frontale doccia VETRUM 115	113-118	39,7-44,3	1070
Frontale doccia VETRUM 120	117-122	40,7-45,7	1050
Frontale doccia VETRUM 125	122-127	40,7-45,7	1051
Frontale doccia VETRUM 130	127-132	45,7-50,7	1052
Frontale doccia VETRUM 135	132-137	45,7-50,7	1053
Frontale doccia VETRUM 140	137-142	50,7-55,7	1054
Frontale doccia VETRUM 145	142-147	50,7-55,7	1055
Frontale doccia VETRUM 150	147-152	55,7-60,7	1056
Frontale doccia VETRUM 155	152-157	55,7-60,7	1057
Frontale doccia VETRUM 160	157-162	60,7-65,7	1058
Frontale doccia VETRUM 165	162-167	60,7-65,7	1059
Frontale doccia VETRUM 170	167-172	65,7-70,7	1060
Frontale doccia VETRUM 175	172-177	60,7-65,7	1061
Frontale doccia VETRUM 180	177-182	65,7-70,7	1062
Profilo espansione +1 cm			1073
Possibilità chiusura profilo inox + guarnizione a bolle *Con questo sistema l'estensibilità diminuisce di 2 cm			1072
Opzione barra inox parallela fino 2 m			5546



Guida e cuscinetto inferiore in acciaio



Cuscinetto acciaio integrato



Opzione barra parallela

VETRUM FREE 1 fisso + 1 scorrevole



Descrizione	Articoli
Freno vetrum free	1071



H202

Altezza



1-6
cm

Incrocio



10/8
mm

Vetro



Scorrevoli



Reversibile



STAINLESS
INOX
STEEL



COPERTURA
GARANTITA

Frontali VETRUM FREE

Descrizione	Estensibilità	Articoli	
Frontale doccia VETRUM FREE 115	111-116	1070 + 1071	
Frontale doccia VETRUM FREE 120	115-120	1050 + 1071	
Frontale doccia VETRUM FREE 125	120-125	1051 + 1071	
Frontale doccia VETRUM FREE 130	125-130	1052 + 1071	
Frontale doccia VETRUM FREE 135	130-135	1053 + 1071	
Frontale doccia VETRUM FREE 140	135-140	1054 + 1071	
Frontale doccia VETRUM FREE 145	140-145	1055 + 1071	
Frontale doccia VETRUM FREE 150	145-150	1056 + 1071	
Frontale doccia VETRUM FREE 155	150-155	1057 + 1071	
Frontale doccia VETRUM FREE 160	155-160	1058 + 1071	
Frontale doccia VETRUM FREE 165	160-165	1059 + 1071	
Frontale doccia VETRUM FREE 170	165-170	1060 + 1071	
Frontale doccia VETRUM FREE 175	170-175	1061 + 1071	
Frontale doccia VETRUM FREE 180	175-180	1062 + 1071	
Profilo espansione +1 cm		1073	



Cuscinetto acciaio integrato



Barra acciaio est. 108 cm ed orientabile



Freno porta scorrevole

VETRUM SPAZIO 2 fissi + 2 scorrevoli



Descrizione

Articoli

Kit di trasformazione spazio

1071



Frontali **VETRUM** 2 fissi + 2 scorrevoli

Descrizione	Estensibilità	Apertura	Articoli
VETRUM SPAZIO 2 fissi + 2 scorrevoli 150x202	134-154	30-50	1067+1067+1071
VETRUM SPAZIO 2 fissi + 2 scorrevoli 170x202	154-174	40-60	1068+1068+1071
VETRUM SPAZIO 2 fissi + 2 scorrevoli 190x202	174-194	50-70	1069+1069+1071
VETRUM SPAZIO 2 fissi + 2 scorrevoli 210x202	213-233	69-89	1070+1070+1071
Profilo espansione +1 cm			1073



Guida e cuscinetto inferiore in acciaio



Cuscinetto acciaio integrato



Barra acciaio est. 108 cm ed orientabile

VETRUM apertura angolare



Descrizione	Articoli	
Lato VETRUM 70 1 fisso+1 scorrevole	1066	
Lato VETRUM 80 1 fisso+1 scorrevole	1067	
Lato VETRUM 90 1 fisso+1 scorrevole	1068	
Lato VETRUM 100 1 fisso+1 scorrevole	1069	
Lato VETRUM 120 1 fisso+1 scorrevole	1070	



VETRUM apertura angolare

Cm	Estensibilità	Apertura	Articoli
70x70	65-70/65-70	26-29	1066+1066
80x70	75-80/65-70	29-32	1067+1066
90x70	85-90/65-70	33-36	1068+1066
100x70	95-100/65-70	37-40	1069+1066
115x70	114-119/65-70	44-49	1070+1066
120x70	118-123/65-70	44-49	1050+1066
125x70	123-128/65-70	45-50	1051+1066
130x70	128-133/65-70	49-54	1052+1066
135x70	133-138/65-70	49-54	1053+1066
140x70	138-143/65-70	55-60	1054+1066
145x70	143-148/65-70	55-60	1055+1066
150x70	148-153/65-70	59-64	1056+1066
Cm	Estensibilità	Apertura	Articoli
80x80	75-80/75-80	33-36	1067+1067
90x80	85-90/75-80	36-39	1068+1067
100x80	95-100/75-80	40-43	1069+1067
115x80	114-119/75-80	46-51	1070+1067
120x80	118-123/75-80	46-51	1050+1067
125x80	123-128/75-80	47-52	1051+1067
130x80	128-133/75-80	51-56	1052+1067
135x80	133-138/75-80	51-56	1053+1067
140x80	138-143/75-80	56-61	1054+1067
145x80	143-148/75-80	56-61	1055+1067
150x80	148-153/75-80	60-65	1056+1067
Cm	Estensibilità	Apertura	Articoli
90x90	85-90/85-90	40-43	1068+1068
100x90	95-100/85-90	43-46	1069+1068
115x90	114-119/85-90	51-54	1070+1068
120x90	118-123/85-90	51-54	1050+1068
125x90	123-128/85-90	50-55	1051+1068
130x90	128-133/85-90	54-59	1052+1068
135x90	133-138/85-90	54-59	1053+1068
140x90	138-143/85-90	58-63	1054+1068
145x90	143-148/85-90	58-63	1055+1068
150x90	148-153/85-90	63-68	1056+1068

Profilo espansione +1 cm

1073

VETRUM frontale + laterale fisso



Descrizione	Estensibilità	Articoli	
Laterale fisso 70 VETRUM 10 mm + braccetto	67-69	1063	
Laterale fisso 75 VETRUM 10 mm + braccetto	72-74	1115	
Laterale fisso 80 VETRUM 10 mm + braccetto	77-79	1064	
Laterale fisso 90 VETRUM 10 mm + braccetto	87-89	1065	



Combinazioni VETRUM frontale + laterale fisso

Cm	Estensibilità	Articoli	Cm	Estensibilità	Articoli
115x70	113-117 / 67-69	1070 +1063	115x75	113-117 / 72-74	1070 + 1115
120x70	116-121 / 67-69	1050 +1063	120x75	116-121 / 72-74	1050 + 1115
125x70	121-126 / 67-69	1051 +1063	125x75	121-126 / 72-74	1051 + 1115
130x70	126-131 / 67-69	1052 +1063	130x75	126-131 / 72-74	1052 + 1115
135x70	131-136 / 67-69	1053 +1063	135x75	131-136 / 72-74	1053 + 1115
140x70	136-141 / 67-69	1054 +1063	140x75	136-141 / 72-74	1054 + 1115
145x70	141-146 / 67-69	1055 +1063	145x75	141-146 / 72-74	1055 + 1115
150x70	146-151 / 67-69	1056 +1063	150x75	146-151 / 72-74	1056 + 1115
155x70	151-156 / 67-69	1057 +1063	155x75	151-156 / 72-74	1057 + 1115
160x70	156-161 / 67-69	1058 +1063	160x75	156-161 / 72-74	1058 + 1115
165x70	161-166 / 67-69	1059 +1063	165x75	161-166 / 72-74	1059 + 1115
170x70	166-171 / 67-69	1060 +1063	170x75	166-171 / 72-74	1060 + 1115
175x70	171-176 / 67-69	1061 +1063	175x75	171-176 / 72-74	1061 + 1115
180x70	176-181 / 67-69	1062 +1063	180x75	176-181 / 72-74	1062 + 1115
115x80	113-117 / 77-79	1070 + 1064	115x90	113-117 / 87-89	1070 + 1065
120x80	116-121 / 77-79	1050 +1064	120x90	116-121 / 87-89	1050 +1065
125x80	121-126 / 77-79	1051 +1064	125x90	121-126 / 87-89	1051 +1065
130x80	126-131 / 77-79	1052 +1064	130x90	126-131 / 87-89	1052 +1065
135x80	131-136 / 77-79	1053 +1064	135x90	131-136 / 87-89	1053 +1065
140x80	136-141 / 77-79	1054 +1064	140x90	136-141 / 87-89	1054 +1065
145x80	141-146 / 77-79	1055 +1064	145x90	141-146 / 87-89	1055 +1065
150x80	146-151 / 77-79	1056 +1064	150x90	146-151 / 87-89	1056 +1065
155x80	151-156 / 77-79	1057 +1064	155x90	151-156 / 87-89	1057 +1065
160x80	156-161 / 77-79	1058 +1064	160x90	156-161 / 87-89	1058 +1065
165x80	161-166 / 77-79	1059 +1064	165x90	161-166 / 87-89	1059 +1065
170x80	166-171 / 77-79	1060 +1064	170x90	166-171 / 87-89	1060 +1065
175x80	171-176 / 77-79	1061 +1064	175x90	171-176 / 87-89	1061 +1065
180x80	176-181 / 77-79	1062 +1064	180x90	176-181 / 87-89	1062 +1065

1073 profilo espansione +1 cm

*Le aperture sono le stesse dei frontali.

Laterali fissi su misura (maggiori informazioni a pagina 282)



Descrizione	Articoli	Taglio
Laterale fisso su misura VETRUM fino 40 cm	1340	
Laterale fisso su misura VETRUM da 40 fino 80 cm	1300	
Laterale fisso su misura VETRUM da 80 fino 120 cm	1306	
Profilo di unione fisso + laterale fisso (vedi pag. 285)	1075	

*Tempo di consegna 3 settimane

temple

"La nobiltà e la forza
dell'acciaio alla portata di
tutti"





TEMPLE

TEMPLE 1 fisso + 1 scorrevole



**H195**

Altezza

**1-6**
cm

Incrocio

**6mm**

Vetro

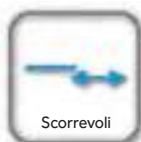

Scorrevoli



G. a palloncino



Reversibile

**STAINLESS
INOX
STEEL****clear
shield
glass**

Frontali TEMPLE 1 fisso+1 scorrevole

Cm	Apertura	TRASPARENTE		FROST PLUS	
		Art.		Art.	
95-100	36-41	5101		6101	
100-105	36-41	5102		6102	
105-110	41-46	5103		6103	
110-115	41-46	5104		6104	
115-120	46-51	5105		6105	
120-125	46-51	5106		6106	
125-130	51-56	5107		6107	
130-135	51-56	5108		6108	
135-140	56-61	5109		6109	
140-145	56-61	5110		6110	
145-150	61-66	5111		6111	
150-155	61-66	5112		6112	
155-160	61-66	5113		6113	
160-165	61-66	5114		6114	
165-170	66-71	5115		6115	
*170-180	66-71	5117		6117	
Profilo espansione per la parte fissa + 1,5 cm				5179	
Adorno in acciaio 195x3,8cm				0008	

*Porta incrocio 1-11 cm



Innovativo sistema di guide con pulsante per liberare l'anta e facilitarne la pulizia



Doppi cuscinetti di ultima generazione in nylon



Adorno in alluminio opzionale



Opzione maniglia	Art.	
Ultrapiatta 22x1,6x0,7 cm	1731	
Lunga 40x1,2x1,5 cm	1732	



Box doccia su misura e cristalli speciali

Altezza fino 195 cm

TRASPARENTE

FROST PLUS
PARSOL / OPACO

*Tempo di consegna 3 settimane (maggiori informazioni a pag. 280)

TEMPLE apertura angolare



Descrizione	TRASPARENTE		FROST PLUS	
	Art.		Art.	
Lato TEMPLE 70 1 fisso+1 scorrevole	5118		6118	
Lato TEMPLE 75 1 fisso+1 scorrevole	5129		6129	
Lato TEMPLE 80 1 fisso+1 scorrevole	5119		6119	
Lato TEMPLE 90 1 fisso+1 scorrevole	5120		6120	
Lato TEMPLE 100 1 fisso+1 scorrevole	5121		6121	
Lato TEMPLE 120 1 fisso+1 scorrevole	5122		6122	
kit unione angolare lato+lato	5123			
Kit unione angolare frontale+lato	5124			

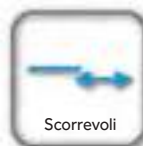

TEMPLE apertura angolare

Cm	Estensibilità	Apert.	TRASPARENTE		FROST PLUS	
Cm	Estensibilità	Apert.	Articoli		Articoli	
70x70	65-70 / 65-70	34-37	5118+5118+5123		6118+6118+5123	
75x70	70-75 / 65-70	36-39	5129+5118+5123		6129+6118+5123	
80x70	75-80 / 65-70	38-41	5119+5118+5123		6119+6118+5123	
90x70	85-90 / 65-70	42-45	5120+5118+5123		6120+6118+5123	
100x70	95-100 / 65-70	46-49	5121+5118+5123		6121+6118+5123	
110x70	104-109 / 65-70	47-50	5102+5118+5124		6102+6118+5124	
120x70	115-120 / 65-70	50-53	5122+5118+5123		6122+6118+5123	
130x70	125-129 / 65-70	55-58	5106+5118+5124		6106+6118+5124	
140x70	135-139 / 65-70	59-62	5108+5118+5124		6108+6118+5124	
Cm	Estensibilità	Apert.	Articoli		Articoli	
75x75	70-75 / 70-75	38-41	5129+5129+5123		6129+6129+5123	
80x75	75-80 / 70-75	40-43	5119+5129+5123		6119+6129+5123	
90x75	85-90 / 70-75	45-48	5120+5129+5123		6120+6129+5123	
100x75	95-100 / 70-75	48-51	5121+5129+5123		6121+6129+5123	
110x75	104-109 / 70-75	49-52	5102+5129+5124		6102+6129+5124	
120x75	115-120 / 70-75	52-55	5122+5129+5123		6122+6129+5123	
130x75	125-129 / 70-75	57-60	5106+5129+5124		6106+6129+5124	
140x75	135-139 / 70-75	61-64	5108+5129+5124		6108+6129+5124	
Cm	Estensibilità	Apert.	Articoli		Articoli	
80x80	75-80 / 75-80	41-44	5119+5119+5123		6119+6119+5123	
90x80	85-90 / 75-80	45-48	5120+5119+5123		6120+6119+5123	
100x80	95-100 / 75-80	49-52	5121+5119+5123		6121+6119+5123	
110x80	104-109 / 75-80	50-53	5102+5119+5124		6102+6119+5124	
120x80	115-120 / 75-80	53-56	5122+5119+5123		6122+6119+5123	
130x80	125-129 / 75-80	57-61	5106+5119+5124		6106+6119+5124	
140x80	135-139 / 75-80	62-65	5108+5119+5124		6108+6119+5124	
Cm	Estensibilità	Apert.	Articoli		Articoli	
90x90	85-90 / 85-90	48-51	5120+5120+5123		6120+6120+5123	
100x90	95-100 / 85-90	52-55	5121+5120+5123		6121+6120+5123	
110x90	104-109 / 85-90	53-56	5102+5120+5124		6102+6120+5124	
120x90	115-120 / 85-90	55-58	5122+5120+5123		6122+6120+5123	
130x90	125-129 / 85-90	61-63	5106+5120+5124		6106+6120+5124	
140x90	135-139 / 85-90	64-67	5108+5120+5124		6108+6120+5124	

*Si possono abbinare misure intermedie. L'estensibilità +4 cm rispetto alla estensibilità del frontale

Descrizione	Articoli
Profilo espansione +1,5 cm	5179



Box doccia su misura e cristalli speciali	TRASPARENTE	FROST PLUS PARSOL / OPACO	TAGLIO
Altezza fino 195 cm			

*Tempo di consegna 3 settimane (maggiori informazioni a pag. 280)

TEMPLE frontale + laterale fisso 8 mm



Descrizione	Estensibilità	TRASPARENTE		FROST PLUS	
		Art.		Art.	
Laterale fisso TEMPLE 70	67-69	5125		6125	
Laterale fisso TEMPLE 75	72-74	5157		6157	
Laterale fisso TEMPLE 80	77-79	5126		6126	
Laterale fisso TEMPLE 90	87-89	5127		6127	



Laterali fissi su misura

Descrizione	TRASPARENTE		FROST PLUS		Taglio
	Art.		Art.		
Lat. fisso su misura fino 40 cm	1349		1349+1312		
Lat. fisso su misura da 40 fino 80 cm	1302		1302+1313		
Lat. fisso su misura da 80 fino 120 cm	1308		1308+1315		

*Tempo di consegna 3 settimane (maggiori informazioni a pagina 282)



Frontali + laterale fisso 8 mm

		TRASPARENTE		FROST PLUS	
Cm	Estensibilità	Articoli		Articoli	
100x70	95-100/67-69	5101+5125		6101+6125	
110x70	105-110/67-69	5103+5125		6103+6125	
120x70	115-120/67-69	5105+5125		6105+6125	
130x70	125-130/67-69	5107+5125		6107+6125	
140x70	135-140/67-69	5109+5125		6109+6125	
150x70	145-150/67-69	5111+5125		6111+6125	
160x70	155-160/67-69	5113+5125		6113+6125	
170x70	165-170/67-69	5115+5125		6115+6125	
*180x70	170-180/67-69	5117+5125		6117+6125	
100x75	95-100/72-74	5101+5157		6101+6157	
110x75	105-110/72-74	5103+5157		6103+6157	
120x75	115-120/72-74	5105+5157		6105+6157	
130x75	125-130/72-74	5107+5157		6107+6157	
140x75	135-140/72-74	5109+5157		6109+6157	
150x75	145-150/72-74	5111+5157		6111+6157	
160x75	155-160/72-74	5113+5157		6113+6157	
170x75	165-170/72-74	5115+5157		6115+6157	
*180x75	170-180/72-74	5117+5157		6117+6157	
100x80	95-100/77-79	5101+5126		6101+6126	
110x80	105-110/77-79	5103+5126		6103+6126	
120x80	115-120/77-79	5105+5126		6105+6126	
130x80	125-130/77-79	5107+5126		6107+6126	
140x80	135-140/77-79	5109+5126		6109+6126	
150x80	145-150/77-79	5111+5126		6111+6126	
160x80	155-160/77-79	5113+5126		6113+6126	
170x80	165-170/77-79	5115+5126		6115+6126	
*180x80	170-180/77-79	5117+5126		6117+6126	
100x90	95-100/87-89	5101+5127		6101+6127	
110x90	105-110/87-89	5103+5127		6103+6127	
120x90	115-120/87-89	5105+5127		6105+6127	
130x90	125-130/87-89	5107+5127		6107+6127	
140x90	135-140/87-89	5109+5127		6109+6127	
150x90	145-150/87-89	5111+5127		6111+6127	
160x90	155-160/87-89	5113+5127		6113+6127	
170x90	165-170/87-89	5115+5127		6115+6127	
*180x90	170-180/87-89	5117+5127		6117+6127	

Si possono abbinare misure intermedie di frontali
*Porta incrocio 1-11 cm

Descrizione	Articoli
Profilo espansione +1,5 cm (valido solo per frontale)	5179
Profilo di unione fisso-fisso (maggiori info pag. 285)	1075

rotary

"Elegante combinazione
di linee dritte e circolari in
acciaio"





ROTARY

ROTARY 1 fisso + 1 scorrevole





Frontali **ROTARY** 1 fisso+1 scorrevole

Cm	Apertura	TRASPARENTE		FROST PLUS	
		Art.		Art.	
95-100	36 - 41	5201		6201	
100-105	36 - 41	5202		6202	
105-110	41 - 46	5203		6203	
110-115	41 - 46	5204		6204	
115-120	46 - 51	5205		6205	
120-125	46 - 51	5206		6206	
125-130	51 - 56	5207		6207	
130-135	51 - 56	5208		6208	
135-140	56 - 61	5209		6209	
140-145	56 - 61	5210		6210	
145-150	61 - 66	5211		6211	
150-155	61 - 66	5212		6212	
155-160	61 - 66	5213		6213	
160-165	61 - 66	5214		6214	
165-170	66 - 71	5215		6215	
*170-180	66 - 71	5217		6217	
Profilo espansione per la parte fissa + 1,5 cm				5179	
Adorno in acciaio 193,7x3,4 cm				0008	

*Porta incrocio 1-11 cm



Innovativo sistema di guide con pulsante per liberare l'anta e facilitarne la pulizia



Cuscinetto innovativo con guida anti-ribaltamento



Adorno in alluminio opzionale

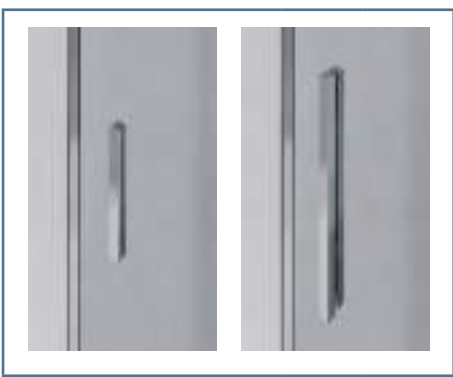

Opzione maniglia	Art.	
Ultrapiatte 22x1,6x0,7 cm	1731	
Lunga 40x1,2x1,5 cm	1732	



Box doccia su misura e cristalli speciali	TRASPARENTE	FROST PLUS PARSOL / OPACO
Altezza fino 197 cm		

*Tempo di consegna 3 settimane (maggiori informazioni a pag. 280)

ROTARY

ROTARY apertura angolare



Descrizione	TRASPARENTE		FROST PLUS	
	Art.		Art.	
Lato ROTARY 70 1 fisso+1 scorrevole	5218		6218	
Lato ROTARY 75 1 fisso+1 scorrevole	5229		6229	
Lato ROTARY 80 1 fisso+1 scorrevole	5219		6219	
Lato ROTARY 90 1 fisso+1 scorrevole	5220		6220	
Lato ROTARY 100 1 fisso+1 scorrevole	5221		6221	
Lato ROTARY 120 1 fisso+1 scorrevole	5222		6222	
Kit unione angolare lato+lato	5223			
Kit unione angolare frontale+lato	5224			



ROTARY apertura angolare

			TRASPARENTE		FROST PLUS	
Cm	Estensibilità	Apertura	Articoli		Articoli	
70x70	65-70 / 65-70	34 - 37	5218+5218+5223		6218+6218+5223	
75x70	70-75 / 65-70	36 - 39	5229+5218+5223		6229+6218+5223	
80x70	75-80 / 65-70	38 - 41	5219+5218+5223		6219+6218+5223	
90x70	85-90 / 65-70	42 - 45	5220+5218+5223		6220+6218+5223	
100x70	95-100 / 65-70	46 - 49	5221+5218+5223		6221+6218+5223	
110x70	104-109 / 65-70	47 - 50	5202+5218+5224		6202+6218+5224	
120x70	115-120 / 65-70	50 - 53	5222+5218+5223		6222+6218+5223	
Cm	Estensibilità	Apertura	Articoli		Articoli	
75x75	70-75 / 70-75	38 - 41	5229+5229+5223		6229+6229+5223	
80x75	75-80 / 70-75	40 - 43	5219+5229+5223		6219+6229+5223	
90x75	85-90 / 70-75	45 - 48	5220+5229+5223		6220+6229+5223	
100x75	95-100 / 70-75	48 - 51	5221+5229+5223		6221+6229+5223	
110x75	104-109 / 70-75	49 - 52	5202+5229+5224		6202+6229+5224	
120x75	115-120 / 70-75	52 - 55	5222+5229+5223		6222+6229+5223	
Cm	Estensibilità	Apertura	Articoli		Articoli	
80x80	75-80 / 75-80	41 - 44	5219+5219+5223		6219+6219+5223	
90x80	85-90 / 75-80	45 - 48	5220+5219+5223		6220+6219+5223	
100x80	95-100 / 75-80	49 - 52	5221+5219+5223		6221+6219+5223	
110x80	104-109 / 75-80	50 - 53	5202+5219+5224		6202+6219+5224	
120x80	115-120 / 75-80	53 - 56	5222+5219+5223		6222+6219+5223	
Cm	Estensibilità	Apertura	Articoli		Articoli	
90x90	85-90 / 85-90	48 - 51	5220+5220+5223		6220+6220+5223	
100x90	95-100 / 85-90	52 - 55	5221+5220+5223		6221+6220+5223	
110x90	104-109 / 85-90	53 - 56	5202+5220+5224		6202+6220+5224	
120x90	115-120 / 85-90	55 - 58	5222+5220+5223		6222+6220+5223	

Descrizione	Articoli
Profilo espansione +1,5 cm	5179



Box doccia su misura e cristalli speciali	TRASPARENTE	FROST PLUS PARSOL / OPACO	TAGLIO
Altezza fino 197 cm			

*Tempo di consegna 3 settimane (maggiori informazioni a pag. 280)

ROTARY frontale + laterale fisso 8 mm



Descrizione	Estensibilità	TRASPARENTE		FROST PLUS	
		Art.		Art.	
Laterale fisso ROTARY 70	67 - 69	5225		6225	
Laterale fisso ROTARY 75	72 - 74	5257		6257	
Laterale fisso ROTARY 80	77 - 79	5226		6226	
Laterale fisso ROTARY 90	87 - 89	5227		6227	



Laterali fissi su misura

Descrizione	TRASPARENTE		FROST PLUS	
	Art.		Art.	
Lat. fisso su misura fino 40 cm	1348		1348+1312	
Lat. fisso su misura da 40 fino 80 cm	1332		1332+1313	
Lat. fisso su misura da 80 fino 120 cm	1333		1333+1315	

*Tempo di consegna 3 settimane (maggiori informazioni a pagina 282)



Frontali + laterale fisso 8 mm

Cm	Estensibilità
100x70	95-100/67-69
110x70	105-110/67-69
120x70	115-120/67-69
130x70	125-130/67-69
140x70	135-140/67-69
150x70	145-150/67-69
160x70	155-160/67-69
170x70	165-170/67-69
*180x70	170-180/67-69
Cm	Estensibilità
100x75	95-100/72-74
110x75	105-110/72-74
120x75	115-120/72-74
130x75	125-130/72-74
140x75	135-140/72-74
150x75	145-150/72-74
160x75	155-160/72-74
170x75	165-170/72-74
*180x75	170-180/72-74
Cm	Estensibilità
100x80	95-100/77-79
110x80	105-110/77-79
120x80	115-120/77-79
130x80	125-130/77-79
140x80	135-140/77-79
150x80	145-150/77-79
160x80	155-160/77-79
170x80	165-170/77-79
*180x80	170-180/77-79
Cm	Estensibilità
100x90	95-100/87-89
110x90	105-110/87-89
120x90	115-120/87-89
130x90	125-130/87-89
140x90	135-140/87-89
150x90	145-150/87-89
160x90	155-160/87-89
170x90	165-170/87-89
*180x90	170-180/87-89

TRASPARENTE	
Articoli	
5201+5225	
5203+5225	
5205+5225	
5207+5225	
5209+5225	
5211+5225	
5213+5225	
5215+5225	
5217+5225	
Articoli	
5201+5257	
5203+5257	
5205+5257	
5207+5257	
5209+5257	
5211+5257	
5213+5257	
5215+5257	
5217+5257	
Articoli	
5201+5226	
5203+5226	
5205+5226	
5207+5226	
5209+5226	
5211+5226	
5213+5226	
5215+5226	
5217+5226	
Articoli	
5201+5227	
5203+5227	
5205+5227	
5207+5227	
5209+5227	
5211+5227	
5213+5227	
5215+5227	
5217+5227	

FROST PLUS	
Articoli	
6201+6225	
6203+6225	
6205+6225	
6207+6225	
6209+6225	
6211+6225	
6213+6225	
6215+6225	
6217+6225	
Articoli	
6201+6257	
6203+6257	
6205+6257	
6207+6257	
6209+6257	
6211+6257	
6213+6257	
6215+6257	
6217+6257	
Articoli	
6201+6226	
6203+6226	
6205+6226	
6207+6226	
6209+6226	
6211+6226	
6213+6226	
6215+6226	
6217+6226	
Articoli	
6201+6227	
6203+6227	
6205+6227	
6207+6227	
6209+6227	
6211+6227	
6213+6227	
6215+6227	
6217+6227	

ROTARY

*Si possono abbinare misure intermedie di frontali. *Porta incrocio 1-11 cm.

Descrizione	Articoli
profilo espansione +1,5 cm (valido solo per frontale)	5179
profilo di unione fisso - fisso (maggiori info pag. 285)	1075

futura

"Combinazione di barra
d'acciaio e cuscinetti a
scomparsa con stile proprio"





FUTURA

FUTURA 1 fisso + 1 scorrevole



**H200**

Altezza

**1-6**
cm

Incrocio

**6mm**

Vetro



Scorrevoli



G. a palloncino



Reversibile

**STAINLESS
INOX
STEEL****CLEAR
SHIELD
GLASS**Frontali **FUTURA** 1 fisso+1 scorrevole

Cm	Apertura	TRASPARENTE		FROST PLUS	
		Art.		Art.	
95-100	36-41	5301		6301	
100-105	36-41	5302		6302	
105-110	41-46	5303		6303	
110-115	41-46	5304		6304	
115-120	46-51	5305		6305	
120-125	46-51	5306		6306	
125-130	51-56	5307		6307	
130-135	51-56	5308		6308	
135-140	56-61	5309		6309	
140-145	56-61	5310		6310	
145-150	61-66	5311		6311	
150-155	61-66	5312		6312	
155-160	61-66	5313		6313	
160-165	61-66	5314		6314	
165-170	66-71	5315		6315	
170-175	66-71	5316		6316	
175-180	66-71	5317		6317	

Profilo espansione per la parte fissa + 1,5 cm

5179

Adorno in acciaio 195x3,8 cm

0008

Composizione per articoli/prezzo a pagina 293.



Profilo ed accessori in acciaio inossidabile



Rivoluzionario sistema di quattro ruote per cuscinetto



Adorno in alluminio opzionale

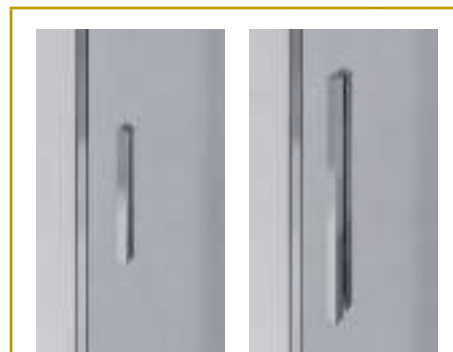

Opzione maniglia	Art.	
Ultrapiatta 22x1,6x0,7 cm	1731	
Lunga 40x1,2x1,5 cm	1732	



Box doccia su misura e cristalli speciali	TRASPARENTE	FROST PLUS PARSOL / OPACO
Altezza fino 200 cm		

*Tempo di consegna 3 settimane

FUTURA SPAZIO 2 fissi + 2 scorrevoli



Descrizione	Estensibilità	Apertura	Incrocio	Articoli
FUTURA SPAZIO 140 (75+75)	132-142	46-56	1-6	5029x2+5351
FUTURA SPAZIO 150 (80+80)	142-152	56-66	1-6	5019x2+5351
FUTURA SPAZIO 160 (85+85)	152-162	54-64	1-6	5030x2+5351
FUTURA SPAZIO 170 (90+90)	162-172	66-76	1-6	5020x2+5351
FUTURA SPAZIO 180 (95+95)	172-182	62-72	1-6	5031x2+5354
FUTURA SPAZIO 190 (100+100)	182-192	76-86	1-6	5021x2+5354
FUTURA SPAZIO 200 (100+100)	190-200	76-86	1-6	5001x2+5354
FUTURA SPAZIO 210 (105+105)	200-210	76-86	1-6	5002x2+5354

Composizione per articoli/prezzo a pagina 293.

Descrizione	Articoli
profilo espansione +1,5 cm	5179



FUTURA SPAZIO FROST PLUS 2 fissi + 2 scorrevoli



Descrizione	Estensibilità	Apertura	Incrocio	Articoli
FUTURA SPAZIO FROST PLUS 140 (75+75)	132-142	46-56	1-6	6029x2+5351
FUTURA SPAZIO FROST PLUS 150 (80+80)	142-152	56-66	1-6	6019x2+5351
FUTURA SPAZIO FROST PLUS 160 (85+85)	152-162	54-64	1-6	6030x2+5351
FUTURA SPAZIO FROST PLUS 170 (90+90)	162-172	66-76	1-6	6020x2+5351
FUTURA SPAZIO FROST PLUS 180 (95+95)	172-182	62-72	1-6	6031x2+5354
FUTURA SPAZIO FROST PLUS 190 (100+100)	182-192	76-86	1-6	6021x2+5354
FUTURA SPAZIO FROST PLUS 200 (100+100)	190-200	76-86	1-6	6001x2+5354
FUTURA SPAZIO FROST PLUS 210 (105+105)	200-210	76-86	1-6	6002x2+5354

Composizione per articoli/prezzo a pagina 293.

Descrizione	Articoli
profilo espansione +1,5 cm	5179

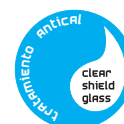

FUTURA apertura angolare



Profilo ed accessori in acciaio inossidabile



Rivoluzionario sistema di quattro ruote per cuscinetto



Guida e profilo salva goccia in acciaio



Maniglia in metallo



			TRASPARENTE		FROST PLUS	
Cm	Estensibilità	Apertura	Articoli		Articoli	
70x70	65-70 / 65-70	34-37	5018+5018+5323		6018+6018+5323	
75x70	70-75 / 65-70	36-39	5029+5018+5323		6029+6018+5323	
80x70	75-80 / 65-70	38-41	5019+5018+5323		6019+6018+5323	
85x70	80-85 / 65-70	40-43	5030+5018+5323		6030+6018+5323	
90x70	85-90 / 65-70	43-45	5020+5018+5323		6020+6018+5323	
95x70	90-95 / 65-70	45-47	5031+5018+5323		6031+6018+5323	
100x70	95-100 / 65-70	46-49	5021+5018+5323		6021+6018+5323	
110x70	104-109 / 65-70	47-50	5002+5018+5323		6002+6018+5323	
120x70	115-120 / 65-70	50-53	5022+5018+5323		6022+6018+5323	
Cm	Estensibilità	Apertura	Articoli		Articoli	
75x75	70-75 / 70-75	38-41	5029+5029+5323		6029+6029+5323	
80x75	75-80 / 70-75	40-43	5019+5029+5323		6019+6029+5323	
85x75	80-85 / 70-75	45-47	5030+5029+5323		6030+6029+5323	
90x75	85-90 / 70-75	45-48	5020+5029+5323		6020+6029+5323	
95x75	90-95 / 70-75	47-50	5031+5029+5323		6031+6029+5323	
100x75	95-100 / 70-75	48-51	5021+5029+5323		6021+6029+5323	
110x75	104-109 / 70-75	49-52	5002+5029+5323		6002+6029+5323	
120x75	115-120 / 70-75	52-55	5022+5029+5323		6022+6029+5323	
Cm	Estensibilità	Apertura	Articoli		Articoli	
80x80	75-80 / 75-80	41-44	5019+5019+5323		6019+6019+5323	
85x80	80-85 / 75-80	43-46	5030+5019+5323		6030+6019+5323	
90x80	85-90 / 75-80	45-48	5020+5019+5323		6020+6019+5323	
95x80	90-95 / 75-80	50-52	5031+5019+5323		6031+6019+5323	
100x80	95-100 / 75-80	49-52	5021+5019+5323		6021+6019+5323	
110x80	104-109 / 75-80	50-53	5002+5019+5323		6002+6019+5323	
120x80	115-120 / 75-80	53-56	5022+5019+5323		6022+6019+5323	
Cm	Estensibilità	Apertura	Articoli		Articoli	
85x90	80-85 / 85-90	46-49	5030+5020+5323		6030+6020+5323	
90x90	85-90 / 85-90	48-51	5020+5020+5323		6020+6020+5323	
95x90	90-95 / 85-90	50-53	5031+5020+5323		6031+6020+5323	
100x90	95-100 / 85-90	52-55	5021+5020+5323		6021+6020+5323	
110x90	104-109 / 85-90	53-56	5002+5020+5323		6002+6020+5323	
120x90	115-120 / 85-90	55-58	5022+5020+5323		6022+6020+5323	

*Composizione per articoli/prezzo a pagina 293.

Descrizione	Articoli
profilo espansione +1,5 cm	5179



Box doccia su misura e cristalli speciali	TRASPARENTE	FROST PLUS PARSOL / OPACO	TAGLIO
Altezza fino 200 cm			

*Tempo di consegna 3 settimane (maggiori informazioni a pag. 280)

FUTURA frontale + laterale fisso 8 mm



Descrizione	Estensibilità	TRASPARENTE		FROST PLUS	
		Art.		Art.	
Laterale fisso FUTURA 70	67-69	5325		6325	
Laterale fisso FUTURA 75	72-74	5357		6357	
Laterale fisso FUTURA 80	77-79	5326		6326	
Laterale fisso FUTURA 90	87-89	5327		6327	

Descrizione	TRASPARENTE		FROST PLUS		Taglio
	Art.		Art.		
Laterali fissi su misura					
Lat. fisso su misura fino 40 cm	1347		1347+1312		
Lat. fisso su misura da 40 fino 80 cm	1330		1330+1313		
Lat. fisso su misura da 80 fino 120 cm	1331		1331+1315		

*Tempo di consegna 3 settimane (maggiori informazioni a pagina 282)



Frontali + laterale fisso 8 mm

		TRASPARENTE		FROST PLUS	
Cm	Estensibilità	Articoli		Articoli	
100x70	95-100/67-69	5301+5325		6301+6325	
110x70	105-110/67-69	5303+5325		6303+6325	
120x70	115-120/67-69	5305+5325		6305+6325	
130x70	125-130/67-69	5307+5325		6307+6325	
140x70	135-140/67-69	5309+5325		6309+6325	
150x70	145-150/67-69	5311+5325		6311+6325	
160x70	155-160/67-69	5313+5325		6313+6325	
170x70	165-170/67-69	5315+5325		6315+6325	
180x70	175-180/67-69	5317+5325		6317+6325	
Cm	Estensibilità	Articoli		Articoli	
100x75	95-100/72-74	5301+5357		6301+6357	
110x75	105-110/72-74	5303+5357		6303+6357	
120x75	115-120/72-74	5305+5357		6305+6357	
130x75	125-130/72-74	5307+5357		6307+6357	
140x75	135-140/72-74	5309+5357		6309+6357	
150x75	145-150/72-74	5311+5357		6311+6357	
160x75	155-160/72-74	5313+5357		6313+6357	
170x75	165-170/72-74	5315+5357		6315+6357	
180x75	175-180/72-74	5317+5357		6317+6357	
Cm	Estensibilità	Articoli		Articoli	
100x80	95-100/77-79	5301+5326		6301+6326	
110x80	105-110/77-79	5303+5326		6303+6326	
120x80	115-120/77-79	5305+5326		6305+6326	
130x80	125-130/77-79	5307+5326		6307+6326	
140x80	135-140/77-79	5309+5326		6309+6326	
150x80	145-150/77-79	5311+5326		6311+6326	
160x80	155-160/77-79	5313+5326		6313+6326	
170x80	165-170/77-79	5315+5326		6315+6326	
180x80	175-180/77-79	5317+5326		6317+6326	
Cm	Estensibilità	Articoli		Articoli	
100x90	95-100/87-89	5301+5327		6301+6327	
110x90	105-110/87-89	5303+5327		6303+6327	
120x90	115-120/87-89	5305+5327		6305+6327	
130x90	125-130/87-89	5307+5327		6307+6327	
140x90	135-140/87-89	5309+5327		6309+6327	
150x90	145-150/87-89	5311+5327		6311+6327	
160x90	155-160/87-89	5313+5327		6313+6327	
170x90	165-170/87-89	5315+5327		6315+6327	
180x90	175-180/87-89	5317+5327		6317+6327	

*Si possono abbinare misure intermedie di frontali.

Descrizione	Articoli
Profilo espansione +1,5 cm (valido solo per frontale)	5179

moving

8mm

"Design classico ed elegante
in acciaio per i clienti più
esigenti"





MOVING

MOVING 1 fisso + 1 scorrevole



**H199**

Altezza

**1-6**
cm

Incrocio

**8mm**

Vetro

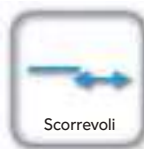

Scorrevoli



Magnetico



Reversibile

**STAINLESS
INOX
STEEL**clear
shield
glass

Frontali MOVING 1 fisso+1 scorrevole

Descrizione	Estensibilità	Apertura	Articoli
Frontale doccia MOVING 100	97-102	40-45	1003
Frontale doccia MOVING 105	102 -107	40-45	1103
Frontale doccia MOVING 110	107-112	45-50	1004
Frontale doccia MOVING 115	112-117	42-47	1104
Frontale doccia MOVING 120	117-122	47-52	1005
Frontale doccia MOVING 125	122-127	52-57	1105
Frontale doccia MOVING 130	127-132	47-52	1006
Frontale doccia MOVING 135	132-137	52-57	1106
Frontale doccia MOVING 140	137-142	57-62	1007
Frontale doccia MOVING 145	142-147	52-57	1107
Frontale doccia MOVING 150	147-152	57-62	1008
Frontale doccia MOVING 155	152-157	57-62	1108
Frontale doccia MOVING 160	157-162	62-67	1009
Frontale doccia MOVING 165	162-167	67-72	1109
Frontale doccia MOVING 170	167-172	62-67	1010
Frontale doccia MOVING 175	172-177	67-72	1110
Frontale doccia MOVING 180	177-182	67-72	1011
Profilo espansione +1 cm			1074
Opzione chiusura profilo + guarnizione a palloncino *Con questo sistema l'estensibilità diminuisce di 2 cm			1072

Guida e profilo salva
goccia in acciaio

Barra e profilo inox



Maniglia in metallo



Profilo inox

MOVING SPAZIO 2 fissi + 2 scorrevoli





Frontali MOVING 2 fissi + 2 scorrevoli

Descrizione	Estensibilità	Apertura	Articoli	
Frontale doccia MOVING STEEL SPAZIO 160	152-162	51-61	1012	
Frontale doccia MOVING STEEL SPAZIO 170	162-172	61-71	1013	
Frontale doccia MOVING STEEL SPAZIO 180	172-182	61-71	1014	
Profilo espansione +1 cm			1074	



Profilo inox



Barra e profilo inox



Maniglia in metallo



Guida e profilo salva goccia in acciaio

MOVING apertura angolare



Descrizione	Articoli	
Lato MOVING 70 1 fisso+1 scorrevole	1000	
Lato MOVING 80 1 fisso+1 scorrevole	1001	
Lato MOVING 90 1 fisso+1 scorrevole	1002	
Lato MOVING 100 1 fisso+1 scorrevole	1102	
Descrizione	Articoli	
Kit di trasformazione ad apertura angolare	1017	

**H199**

Altezza

**1-6**
cm

Incrocio

**8**
mm

Vetro



Scorrevoli



Magnetico



Reversibile

**STAINLESS
INOX
STEEL**

CE

combinazioni MOVING apertura angolare

Cm	Estensibilità	Apertura	Articoli
70x70	66-70/66-70	34-36	1000+1000+1017
80x70	76-80/66-70	38-40	1001+1000+1017
90x70	86-90/66-70	42-44	1002+1000+1017
100x70	96-100/66-70	45-47	1102+1000+1017
110x70	104-109/66-70	47-49	1103+1000+1017
120x70	116-122/66-70	49-51	1104+1000+1017
130x70	124-129/66-70	57-59	1105+1000+1017
140x70	134-139/66-70	57-59	1106+1000+1017
Cm	Estensibilità	Apertura	Articoli
80x80	76-80/76-80	41-43	1001+1001+1017
90x80	86-90/76-80	45-47	1002+1001+1017
100x80	96-100/76-80	48-50	1102+1001+1017
110x80	104-109/76-80	50-52	1103+1001+1017
120x80	116-122/76-80	52-54	1104+1001+1017
130x80	124-129/76-80	60-62	1105+1001+1017
140x80	134-139/76-80	60-62	1106+1001+1017
Cm	Estensibilità	Apertura	Articoli
90x90	86-90/86-90	48-50	1002+1002+1017
100x90	96-100/86-90	51-53	1102+1002+1017
110x90	104-109/86-90	53-55	1103+1002+1017
120x90	116-122/86-90	55-57	1104+1002+1017
130x90	124-129/86-90	63-65	1105+1002+1017
140x90	134-139/86-90	63-65	1106+1002+1017

Profilo espansione +1 cm

1074

*Si possono anche abbinare i frontali con misure intermedie.

*L'estensibilità aumenta 2 cm rispetto al formato frontale.



MOVING frontale + laterale fisso



Descrizione	Estensibilità	Articoli	
Laterale fisso MOVING 70	67-69	1015	
Laterale fisso MOVING 75	72-74	1100	
Laterale fisso MOVING 80	77-79	1016	
Laterale fisso MOVING 90	87-89	1018	

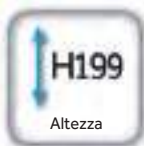

combinazioni frontali MOVING + laterale fisso 8 mm

Cm	Estensibilità	Articoli	Cm	Estensibilità	Articoli
100X70	96-100/67-69	1003+1015	100X75	96-100/72-74	1003+1100
110X70	106-110/67-69	1004+1015	110X75	106-110/72-74	1004+1100
120X70	116-120/67-69	1005+1015	120X75	116-120/72-74	1005+1100
130X70	126-130/67-69	1006+1015	130X75	126-130/72-74	1006+1100
140X70	136-140/67-69	1007+1015	140X75	136-140/72-74	1007+1100
150X70	146-150/67-69	1008+1015	150X75	146-150/72-74	1008+1100
160X70	156-160/67-69	1009+1015	160X75	156-160/72-74	1009+1100
170X70	166-170/67-69	1010+1015	170X75	166-170/72-74	1010+1100
180X70	176-180/67-69	1011+1015	180X75	176-180/72-74	1011+1100
100X80	96-100/77-79	1003+1016	100X90	96-100/87-89	1003+1018
110X80	106-110/77-79	1004+1016	110X90	106-110/87-89	1004+1018
120X80	116-120/77-79	1005+1016	120X90	116-120/87-89	1005+1018
130X80	126-130/77-79	1006+1016	130X90	126-130/87-89	1006+1018
140X80	136-140/77-79	1007+1016	140X90	136-140/87-89	1007+1018
150X80	146-150/77-79	1008+1016	150X90	146-150/87-89	1008+1018
160X80	156-160/77-79	1009+1016	160X90	156-160/87-89	1009+1018
170X80	166-170/77-79	1010+1016	170X90	166-170/87-89	1010+1018
180X80	176-180/77-79	1011+1016	180X90	176-180/87-89	1011+1018

Profilo parete (+1cm) **1074**

*Si possono anche abbinare i frontali con misure intermedie.

*Estensibilità -2 cm rispetto al formato frontale.

*L'apertura é la stessa dei frontali.



Laterali fissi su misura (maggiori informazioni a pagina 282)

Descrizione	Articoli	Taglio
Laterale fisso su misura MOVING fino 40 cm	1341	
Laterale fisso su misura MOVING da 40 fino 80 cm	1301	
Laterale fisso su misura MOVING da 80 fino 120 cm	1307	
Profilo unione fisso a laterale fisso (vedi pag. 285)	1075	

*Tempo di consegna 3 settimane

screen

8mm

"Semplicità e bellezza con un'ampia gamma di opzioni e colori"





SCREEN

Combinazione con articoli 0160+0166



	TRASPARENTE		FROST PLUS	
Descrizione	Art.		Art.	
Crist. fisso 68	0164		0174	
Crist. fisso 78	0165		0175	
Crist. fisso 88	0160		0170	
Crist. fisso 98	0161		0171	
Crist. fisso 108	0162		0172	
Crist. fisso 118	0169		0179	

Descrizione	Art.
Braccetto supporto PARETE diritto est. (55-100)	0166
Braccetto supporto PARETE 45° est. (55-85)	0168
Braccetto supporto CRISTALLO-CRISTALLO est. (55-85)	0167
Braccetto quadrato PARETE diritto/45° regolabile (60-120)	0184

*Altre opzioni di braccetto (vedi pag. 167).

*Fissi su misura (vedi pag. 283)

Braccetto 0166



Braccetto 0168



Braccetto 0167



Braccetto 0184



SCREEN MOVING

Combinazione con articoli 0170+0194+0166

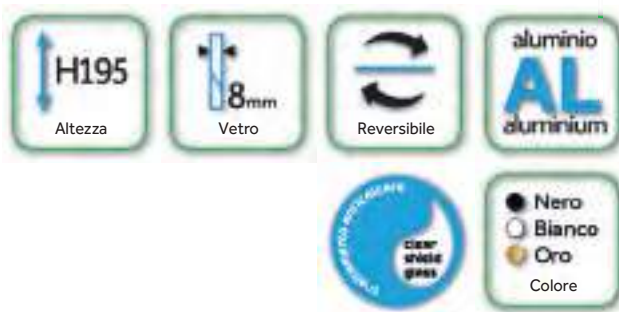

	TRASPARENTE	FROST PLUS
Descrizione	Art.	Art.
Cr. mobile 25 cm	0153	0193
Cr. mobile 40 cm	0154	0194

Il vetro mobile aumenta 24,5 / 39,5 cm la misura dei fissi

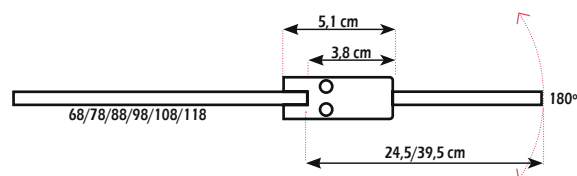

SCREEN 35 CERNIERA 180°

Combinazione con articoli 0160+0331+0166



Cerniera ottone cromato

	TRASPARENTE	FROST PLUS
Descrizione	Art.	Art.
Cr. mobile di 35 cm	0331	0332

*Cerniera su misura (vedi pag. 283)

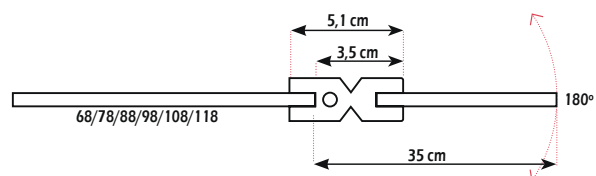

SCREEN GOLD

Oro spazzolato



Descrizione	TRASPARENTE		FROST PLUS	
	Art.		Art.	
Screen Gold 68 cm + braccetto supporto oro	SC70OR		SC70FOR	
Screen Gold 78 cm + braccetto supporto oro	SC80OR		SC80FOR	
Screen Gold 88 cm + braccetto supporto oro	SC90OR		SC90FOR	
Screen Gold 98 cm + braccetto supporto oro	SC100OR		SC100FOR	
Screen Gold 108 cm + braccetto supporto oro	SC110OR		SC110FOR	
Screen Gold 118 cm + braccetto supporto oro	SC120OR		SC120FOR	

*Include braccio girevole/regolabile 60-120 cm.

SCREEN GOLD su misura

Descrizione	TRASPARENTE		FROST PLUS	
	Art.		Art.	
Larghezza < 80 cm Altezza fino 195 cm	1305OR		1305OR+1313	
Larghezza 80 a 120 cm Altezza fino 195 cm	1311OR		1311OR+1315	

*Braccio regolabile non incluso 60-120 cm Screen Gold art. 0187
Tempo di consegna 3 settimane

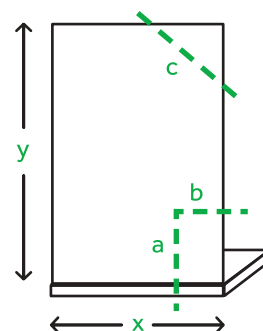

TAGLIO QUADRATO/TAGLIO
PER CRISTALLO SU MISURA
Art.: 0862

SCREEN GOLD cerniera mobile 180°

Oro spazzolato



SCREEN

	TRASPARENTE		FROST PLUS	
Descrizione	Art.		Art.	
Cr. mobile di 35 cm	0331+0334		0332+0334	

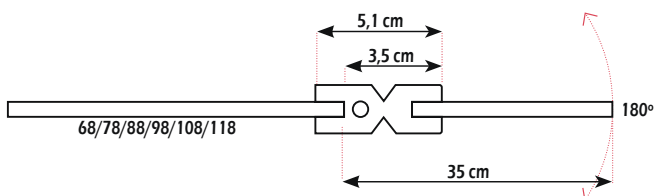

SCREEN GOLD cerniera mobile 180° su misura

Cr. mobile su misura	TRASPARENTE		FROST PLUS	
Cm	Art.		Art.	
Fino a 40 cm	1355OR		1357OR	
Da 41 a 80 cm	1356OR		1358OR	

Tempo di consegna 3 settimane

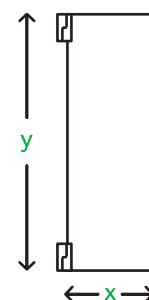

SCREEN BLACK



Descrizione	TRASPARENTE		FROST PLUS	
	Art.		Art.	
Screen Black 68 cm + braccetto supporto nero	SC70N		SC70FN	
Screen Black 78 cm + braccetto supporto nero	SC80N		SC80FN	
Screen Black 88 cm + braccetto supporto nero	SC90N		SC90FN	
Screen Black 98 cm + braccetto supporto nero	SC100N		SC100FN	
Screen Black 108 cm + braccetto supporto nero	SC110N		SC110FN	
Screen Black 118 cm + braccetto supporto nero	SC120N		SC120FN	

*Include braccio girevole/regolabile 60-120 cm. Opzione barra parallela 9027

SCREEN BLACK su misura

Descrizione	TRASPARENTE		FROST PLUS	
	Art.		Art.	
Larghezza < 80 cm Altezza fino 195 cm	1305N		1305N+1313	
Larghezza 80 a 120 cm Altezza fino 195 cm	1311N		1311N+1315	

*Braccio regolabile non incluso 60-120 cm Screen Black art. 0990
Tempo di consegna 3 settimane

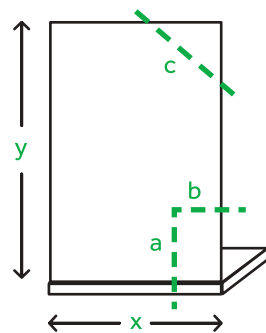

TAGLIO QUADRATO/TAGLIO
PER CRISTALLO SU MISURA
Art.: 0862

SCREEN BLACK cerniera mobile 180°



	TRASPARENTE		FROST PLUS	
Descrizione	Art.		Art.	
Cr. mobile 35 cm	0331N		0332+9021	

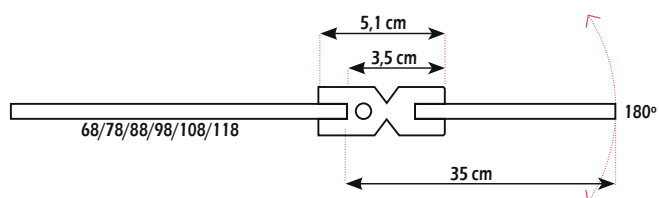

SCREEN BLACK cerniera mobile 180° su misura

Cr. mobile su misura	TRASPARENTE		FROST PLUS	
Cm	Art.		Art.	
Fino a 40 cm	1355N		1357N	
Da 41 a 80 cm	1356N		1358N	

Tempo di consegna 3 settimane

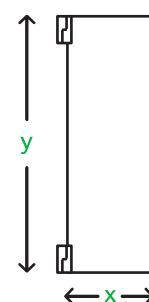

SCREEN WHITE



Cm	TRASPARENTE		FROST PLUS	
	Art.		Art.	
Screen White 68 cm + braccetto supporto bianco	SC70B		SC70FB	
Screen White 78 cm + braccetto supporto bianco	SC80B		SC80FB	
Screen White 88 cm + braccetto supporto bianco	SC90B		SC90FB	
Screen White 98 cm + braccetto supporto bianco	SC100B		SC100FB	
Screen White 108 cm + braccetto supporto bianco	SC110B		SC110FB	
Screen White 118 cm + braccetto supporto bianco	SC120B		SC120FB	

*Include braccio girevole/regolabile 60-120 cm

SCREEN WHITE su misura

Descrizione	TRASPARENTE		FROST PLUS	
	Art.		Art.	
Larghezza < 80 cm Altezza fino 195 cm	1305B		1305B+1313	
Larghezza 80 a 120 cm Altezza fino 195 cm	1311B		1311B+1315	

*Braccio regolabile non incluso 60-120 cm Screen White art. 0186
Tempo di consegna 3 settimane

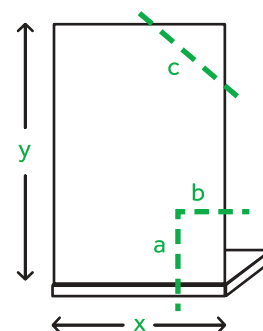

TAGLIO QUADRATO/TAGLIO PER CRISTALLO SU MISURA
Art.: 0862

SCREEN WHITE cerniera mobile 180°



SCREEN

	TRASPARENTE		FROST PLUS	
Descrizione	Art.		Art.	
Cr. mobile di 35 cm	0331+0333		0332+0333	

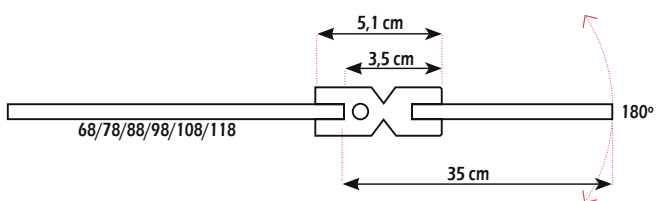

SCREEN WHITE cerniera mobile 180° su misura

	TRASPARENTE		FROST PLUS	
Descrizione	Art.		Art.	
Fino 40 cm	1355B		1357B	
Da 41 a 80 cm	1356B		1358B	

Tempo di consegna 3 settimane

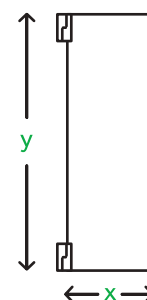

SCREEN BLACK SCACCHI



Combinazione con articoli 0983+0990



Articoli 0983+0986+0990

Opzione profilo nero 2 m

Cm	Estensibilità	Art.	
Black Scacchi 70x195 + braccetto supporto	67/69,5	0980+0990	
Black Scacchi 80x195 + braccetto supporto	77/79,5	0981+0990	
Black Scacchi 90x195 + braccetto supporto	87/89,5	0982+0990	
Black Scacchi 100x195 + braccetto supporto	97/99,5	0983+0990	
Black Scacchi 110x195 + braccetto supporto	107/109,5	0984+0990	
Black Scacchi 120x195 + braccetto supporto	117/119,5	0985+0990	
35x195 cm pieghevole, installazione a destra		0986	
35x195 cm pieghevole, installazione a sinistra		0987	



Art.	
0993	

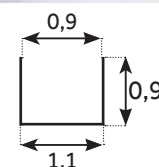

SCREEN BLACK SCACCHI XXL

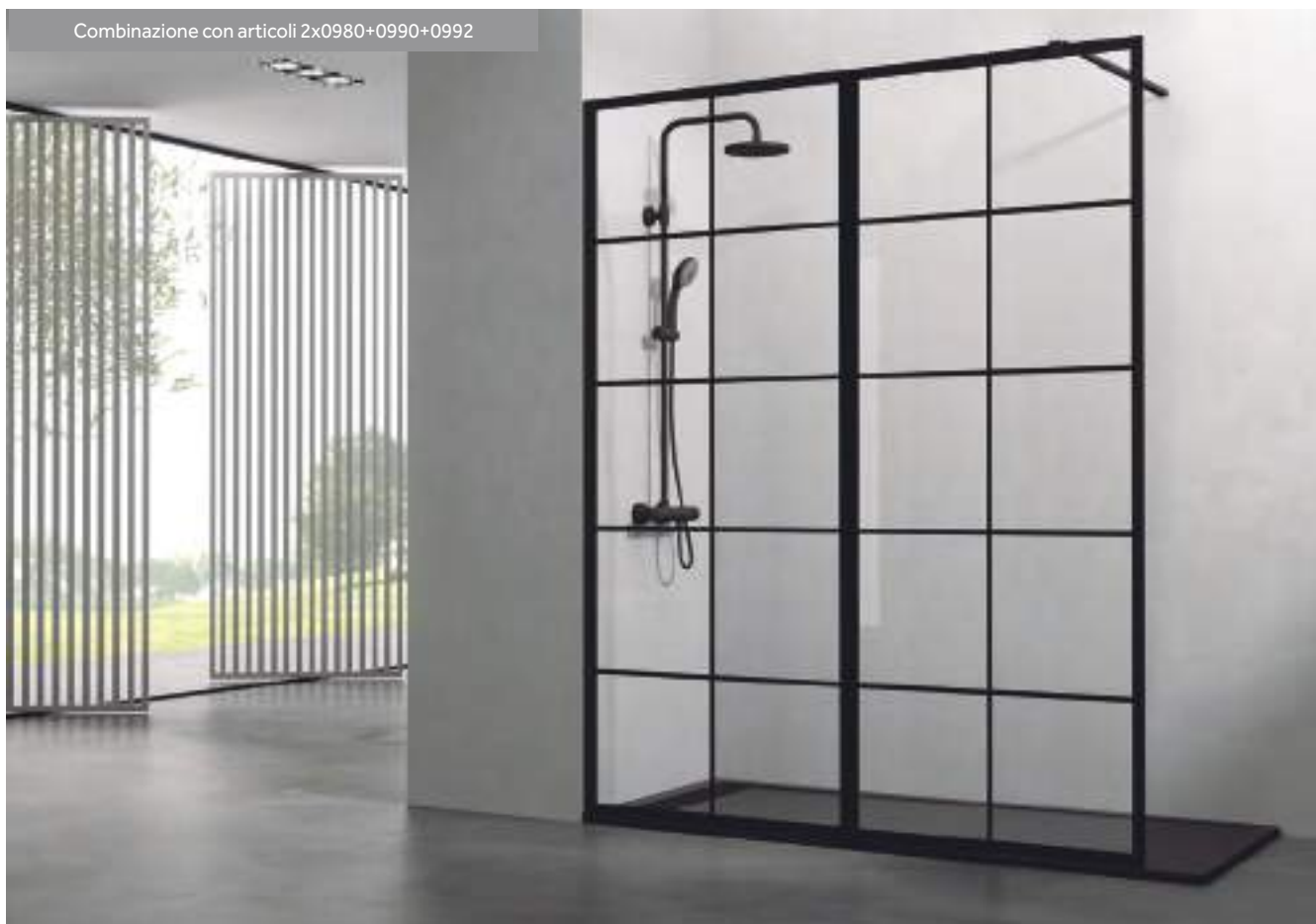

Utilizza il nuovo profilo di unione art. 0992 per unire qualsiasi articolo di fissi Screen Black ed ottenere misure superiori a 120 cm.

Descrizione	Art.	
profilo di unione nero per 2 cristalli fissi	0992	

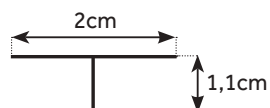

Articoli 0980+0983+0991+0990



BLACK SCACCHI ANGOLARE

Descrizione	Articolo	
Profilo angolare nero	0991	

*Aumentare di 1,3 cm in uno dei lati

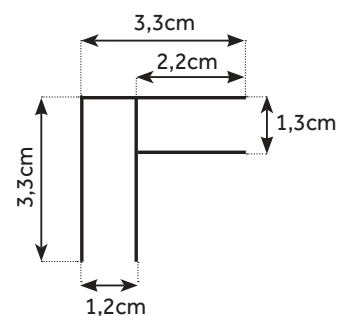

Braccetti per Screen, Open e Glass

Barra con 1 supporto + supporto laterale
fisso



Supporto fissaggio a parete

Descrizione	Art.	
Barra 140 con supporto (per frontale)	1716	
Barra 140 supporto + supporto laterale fisso	1716+1718	



Supporto fissaggio al fisso

Barra con 2 supporti



Supporto fissaggio a laterale
fisso art.1718

Descrizione	Art.	
Barra 200 con due supporti (per frontale)	1717	
Barra 200 due supporti + supporto laterale fisso	1717+1718	



Descrizione	Art.	
Barra apertura angolare GLASS/OPEN	1716x2+1730	



Descrizione	Art.	
Appendiabiti GME	0012	



Descrizione	Art.	
Barra soffitto Screen	0188	

Altezza massima 260 cm



Descrizione	Art.	
Braccetto 60-120 cm quadrato diritto/45°	0184	



Descrizione	Art.	
Braccetto 60-120 cm nero diritto/45°	0990	



Descrizione	Art.	
Braccetto 60-120 cm bianco diritto/45°	0186	



Descrizione	Art.	
Braccetto 60-120 cm oro diritto/45°	0187	



Descrizione	Art.	
Barra 140 con supporto nero	9026	
Barra 200 con supporto nero	9027	



Descrizione	Art.	
Angolo minimale 20x40 cm	1719	

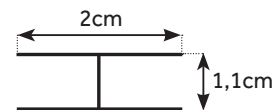

Descrizione	Art.	
profilo di unione per 2 fissi	0180	
profilo di unione nero per 2 fissi	0992	

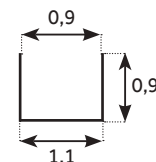

Descrizione	Art.	
Opzione profilo in alluminio 2 m	0994	
Opzione profilo nero 2 m	0993	

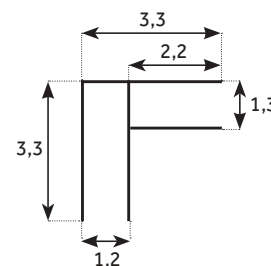

Descrizione	Art.	
Profilo angolare	0182	
Profilo angolare nero	0991	

*Aumentare di 1,3 cm su un lato

GME

OPEN pg.170



OPEN BLACK pg.204



GLASS pg.226



A BATTENTE

BOX DOCCIA PORTE A BATTENTE

open

"Programma modulare di
fissi e porte che si adattano
a qualsiasi spazio"





OPEN

OPEN COMBI A porta con chiusura magnetica a parete



**H195**

Altezza

**6mm**

Vetro



A battente 90°

**1.5cm**

Espandibile



Reversibile

aluminio
AL
aluminiumclear
shield
glass

● Nero

Vedi pag. 204

COMBI A

Cm	Estensibilità cm	Apertura	TRASPARENTE		FROST PLUS	
			Articoli		Articoli	
40	41,1-42,6	33	1216 + 1211		-	
45	46,1-47,6	38	1217 + 1211		-	
50	51,1-52,6	43	1207 + 1211		1284 + 1211	
55	56,1-57,6	48	1218 + 1211		1285 + 1211	
60	61,1-62,6	53	1219 + 1211		1286 + 1211	
65	66,1-67,6	58	1208 + 1211		1287 + 1211	
70	71,1-72,6	63	1209 + 1211		1288 + 1211	
75	76,1-77,6	68	1220 + 1211		1289 + 1211	
80	81,1-82,6	73	1210 + 1211		1290 + 1211	
85	86,1-87,6	78	1223 + 1211		1291 + 1211	

*Permette unione con laterali fissi STD nel lato della porta usando Art. 1222 (estensione minima +1,8 cm), vedi pag. 202

Descrizione	Art.
-------------	------

Profilo espansione porte (+1,5 a +3 cm)

1222



Profilo a parete Open

1211

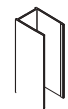

Profilo porta (riduce fino 1 cm l'estensione)

1215



Magnete espansione +1,2 cm

1221

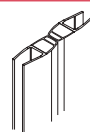

Opzione apertura IN-OUT 180°

1213



Opzione 180°

OPEN COMBI A + lat. fisso



Opzione barra 140 cm + supporto laterale fisso-Art. 1716+1718 (si esclude braccetto 1214)

Lat. fissi 6 mm	TRASPARENTE		FROST PLUS	
Estensibilità cm	Art.		Art.	
66-69	1720		1292	
76-79	1721		1293	
86-89	1722		1294	
Braccetto Open	1214			

Descrizione	Articoli	
Profilo espansione +2 cm	0218	
Profilo espansione +4 cm	0029	
Profilo espansione +5,5 cm	0219	



Laterali fissi su misura 6 mm

Descrizione	TRASPARENTE		FROST PLUS		Taglio
	Art.		Art.		
Lat. fisso su misura fino 40 cm	1345		1345+1312		
Lat. fisso su misura da 40 fino 80 cm	1316		1316+1313		
Lat. fisso su misura da 80 fino 120 cm	1317		1317+1315		

*Tempo di consegna 3 settimane. Altre informazioni ver pag. 282.



Vedi pag. 205

Cm	Estensibilità	TRASPARENTE		FROST PLUS	
		Articoli		Articoli	
COMBI A + LATERALE FISSO 70 c/BRACCETTO 1214					
40X70	40,6-42,1/66-69	1216+1211+1720+1214		-	
45X70	45,6-47,1/66-69	1217+1211+1720+1214		-	
50X70	50,6-52,1/66-69	1207+1211+1720+1214		1284+1211+1292+1214	
55X70	55,6-57,1/66-69	1218+1211+1720+1214		1285+1211+1292+1214	
60X70	60,6-62,1/66-69	1219+1211+1720+1214		1286+1211+1292+1214	
65X70	65,6-67,1/66-69	1208+1211+1720+1214		1287+1211+1292+1214	
70X70	70,6-72,1/66-69	1209+1211+1720+1214		1288+1211+1292+1214	
75X70	75,6-77,1/66-69	1220+1211+1720+1214		1289+1211+1292+1214	
80X70	80,6-82,1/66-69	1210+1211+1720+1214		1290+1211+1292+1214	
85X70	85,6-87,1/66-69	1223+1211+1720+1214		1291+1211+1292+1214	
COMBI A + LATERALE FISSO 80 c/BRACCETTO 1214					
40X80	40,6-42,1/76-79	1216+1211+1721+1214		-	
45X80	45,6-47,1/76-79	1217+1211+1721+1214		-	
50X80	50,6-52,1/76-79	1207+1211+1721+1214		1284+1211+1293+1214	
55X80	55,6-57,1/76-79	1218+1211+1721+1214		1285+1211+1293+1214	
60X80	60,6-62,1/76-79	1219+1211+1721+1214		1286+1211+1293+1214	
65X80	65,6-67,1/76-79	1208+1211+1721+1214		1287+1211+1293+1214	
70X80	70,6-72,1/76-79	1209+1211+1721+1214		1288+1211+1293+1214	
75X80	75,6-77,1/76-79	1220+1211+1721+1214		1289+1211+1293+1214	
80X80	80,6-82,1/76-79	1210+1211+1721+1214		1290+1211+1293+1214	
85X80	85,6-87,1/76-79	1223+1211+1721+1214		1291+1211+1293+1214	
COMBI A + LATERALE FISSO 90 c/BRACCETTO 1214					
40X90	40,6-42,1/86-89	1216+1211+1722+1214		-	
45X90	45,6-47,1/86-89	1217+1211+1722+1214		-	
50X90	50,6-52,1/86-89	1207+1211+1722+1214		1284+1211+1294+1214	
55X90	55,6-57,1/86-89	1218+1211+1722+1214		1285+1211+1294+1214	
60X90	60,6-62,1/86-89	1219+1211+1722+1214		1286+1211+1294+1214	
65X90	65,6-67,1/86-89	1208+1211+1722+1214		1287+1211+1294+1214	
70X90	70,6-72,1/86-89	1209+1211+1722+1214		1288+1211+1294+1214	
75X90	75,6-77,1/86-89	1220+1211+1722+1214		1289+1211+1294+1214	
80X90	80,6-82,1/86-89	1210+1211+1722+1214		1290+1211+1294+1214	
85X90	85,6-87,1/86-89	1223+1211+1722+1214		1291+1211+1294+1214	

Le aperture sono le stesse dei frontali.



Opzione barra 140 cm + supporto laterale fisso - Art. 1716+1718
Aumenta di 60 p (si esclude braccetto 1214)

Apertura esterna
90° p/fisso



Opzione in-out
180° p/fisso



L'estensibilità del frontale con apertura
in-out aumenterà di 1,4 cm e l'estensibilità
del laterale fisso si riduce di 1 cm.
Art. 0038

OPEN COMBI B porta con profilo a chiusura magnetica





COMBI B

Cm	Estens cm	Apertura	TRASPARENTE		FROST PLUS	
			Articoli		Articoli	
45	43,6-47,6	33	1216 + 1211 + 1212		-	
50	48,6-52,6	38	1217 + 1211 + 1212		-	
55	53,6-57,6	43	1207 + 1211 + 1212		1284 + 1211 + 1212	
60	58,6-62,6	48	1218 + 1211 + 1212		1285 + 1211 + 1212	
65	63,6-67,6	53	1219 + 1211 + 1212		1286 + 1211 + 1212	
70	68,6-72,6	58	1208 + 1211 + 1212		1287 + 1211 + 1212	
75	73,6-77,6	63	1209 + 1211 + 1212		1288 + 1211 + 1212	
80	78,6-82,6	68	1220 + 1211 + 1212		1289 + 1211 + 1212	
85	83,6-87,6	73	1210 + 1211 + 1212		1290 + 1211 + 1212	
90	88,6-92,6	78	1223 + 1211 + 1212		1291 + 1211 + 1212	

Permette unione con laterali fissi STD nel lato profilo a chiusura magnetica (estensione minima +0,7 cm, espansione +1,5 cm), vedi pag. 202.
 Permette unione con laterali fissi STD nel lato porta usando art. 1222 (estensione minima +1,8 cm, espansione +2,5 cm), vedi pag. 202.

Descrizione	Ref
Profilo espansione lato profilo a chiusura magnetica +3 cm	0218
Profilo espansione lato profilo a chiusura magnetica +6 cm	0029
Profilo chiusura magnetica	1212
Profilo a parete Open	1211
Profilo porta (riduce fino 1 cm l'estensione), vedi pag. 285	1215
Magnete espansione +1,2 cm, vedi pag. 285	1221
Profilo espansione laterale porta +2,5 cm, vedi pag. 285	1222
Opzione apertura IN-OUT 180°	1213

OPEN COMBI C fisso + porta a battente con chiusura magnetica a parete



FISSI	TRASPARENTE		FROST PLUS	
	Art.	P	Art.	
Estensibilità cm				
17,5-20	1200	180	-	
22,5-25	1201	192	-	
27,5-30	1202	204	1280	
37,5-40	1203	228	1281	
47,5-50	1204	252	1282	
57,5-60	1205	275	1283	

(2,5 regolazione)



Pannelli fissi su misura (vedi pag. 281)

PORTE	TRASPARENTE		FROST PLUS	
	Art.		Art.	
Misura cm				
40	1216		-	
45	1217		-	
50	1207		1284	
55	1218		1285	
60	1219		1286	
65	1208		1287	
70	1209		1288	
75	1220		1289	
80	1210		1290	
85	1223		1291	

(non regolabile)



Abbinamenti con porte 50, 55, 65, 70, 80 e 85

COMBI C

Cm	Estensibilità	Fisso	Porta	Apertura
70	67,5-70	20	50	43
75	72,5-75	25	50	43
80	77,5-80	30	50	43
85	82,5-85	30	55	48
90	87,5-90	40	50	43
95	92,5-95	30	65	58
100	97,5-100	30	70	63
100	97,5-100	50	50	43
105	102,5-105	40	65	58
110	107,5-110	30	80	73
110	107,5-110	40	70	63
110	107,5-110	60	50	43
115	112,5-115	50	65	58
120	117,5-120	40	80	73
120	117,5-120	50	70	63
125	122,5-125	60	65	58
130	127,5-130	50	80	73
130	127,5-130	60	70	63
135	132,5-135	50	85	78
140	137,5-140	60	80	73
145	142,5-145	60	85	78

TRASPARENTE		FROST PLUS	
Art.		Art.	
1200+1207		-	
1201+1207		-	
1202+1207		1280+1284	
1202+1218		1280+1285	
1203+1207		1281+1284	
1202+1208		1280+1287	
1202+1209		1280+1288	
1204+1207		1282+1284	
1203+1208		1281+1287	
1202+1210		1280+1290	
1203+1209		1281+1288	
1205+1207		1283+1284	
1204+1208		1282+1287	
1203+1210		1281+1290	
1204+1209		1282+1288	
1205+1208		1283+1287	
1204+1210		1282+1290	
1205+1209		1283+1288	
1204+1223		1282+1291	
1205+1210		1283+1290	
1205+1223		1283+1291	

*Permette combinazione con laterale fisso STD nel lato fisso, estensione minima +0,7 (non regolabile), vedi pag. 202

*Permette combinazione con laterale fisso Glass nel lato della porta, l'estensione del frontale si riduce di 0,5 cm

Descrizione	Art.
Profilo espansione +3 cm lato fisso	0218
Profilo espansione +6 cm lato fisso	0029
Magnete espansione +1,2 cm, vedi pag. 285	1221
Opzione apertura IN-OUT 180°	1213

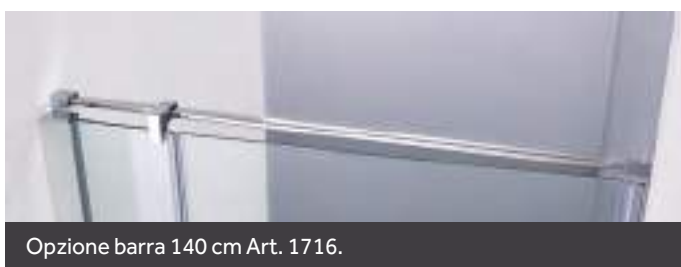

Opzione barra 140 cm Art. 1716.



*Opzione per installazione formato free, estensibilità -3cm

OPEN COMBI C + lat. fisso



Opzione barra 140 cm + supporto laterale fisso-Art. 1716+1718 (si esclude braccetto 1214)

Laterali fissi 6 mm

Descrizione	Estensibilità	Art.	
Laterale fisso 70x195	66-69	1720	
Laterale fisso 80x195	76-79	1721	
Laterale fisso 90x195	86-89	1722	
Braccetto Open		1214	

Descrizione	Articoli	
Profilo espansione +2 cm	0218	
Profilo espansione +4 cm	0029	
Profilo espansione +5,5 cm	0219	



Laterali fissi TRASPARENTI su misura 6 mm (maggiori informazioni a pagina 282)

Descrizione	Art.		
Laterale fisso su misura OPEN fino 40 cm	1345		
Laterale fisso su misura OPEN da 40 fino 80 cm	1316		
Laterale fisso su misura OPEN da 80 fino 120 cm	1317		

*Tempo di consegna 3 settimane.

COMBI C + LATERALE FISSO 70 c/BRACCETTO 1214

Cm (F+A) xLF	Estensibilità	Articolo
70 (20+50) x70	67-69,5/66-69	1200+1207+1720+1214
75 (25+50) x70	72-74,5/66-69	1201+1207+1720+1214
80 (30+50) x70	77-79,5/66-69	1202+1207+1720+1214
85 (20+65) x70	82-84,5/66-69	1200+1208+1720+1214
90 (20+70) x70	87-89,5/66-69	1200+1209+1720+1214
90 (25+65) x70	87-89,5/66-69	1201+1208+1720+1214
90 (40+50) x70	87-89,5/66-69	1203+1207+1720+1214
95 (25+70) x70	92-94,5/66-69	1201+1209+1720+1214
95 (30+65) x70	92-94,5/66-69	1202+1208+1720+1214
100 (20+80) x70	97-99,5/66-69	1200+1210+1720+1214
100 (30+70) x70	97-99,5/66-69	1202+1209+1720+1214
100 (50+50) x70	97-99,5/66-69	1204+1207+1720+1214
105 (25+80) x70	102-104,5/66-69	1201+1210+1720+1214
105 (40+65) x70	102-104,5/66-69	1203+1208+1720+1214
110 (30+80) x70	107-109,5/66-69	1202+1210+1720+1214
110 (40+70) x70	107-109,5/66-69	1203+1209+1720+1214
110 (60+50) x70	107-109,5/66-69	1205+1207+1720+1214
115 (50+65) x70	112-114,5/66-69	1204+1208+1720+1214
120 (40+80) x70	117-119,5/66-69	1203+1210+1720+1214
120 (50+70) x70	117-119,5/66-69	1204+1209+1720+1214
125 (60+65) x70	122-124,5/66-69	1205+1208+1720+1214
130 (50+80) x70	127-129,5/66-69	1204+1210+1720+1214
130 (60+70) x70	127-129,5/66-69	1205+1209+1720+1214
140 (60+80) x70	137-139,5/66-69	1205+1210+1720+1214
145 (60+85) x70	142-144,5/66-69	1205+1223+1720+1214

Apertura esterna
90° p/fisso



Opzione in-out
180° p/fisso



L'estensibilità del frontale con apertura in-out aumenterà di 1,4 cm e l'estensibilità del laterale fisso si riduce di 1 cm. Art. 0038



Opzione barra 140 cm + supporto laterale fisso-Art. 1716+1718 (si esclude braccetto 1214)

COMBI C + LATERALE FISSO 80 c/BRACCETTO 1214

Cm (F+A) xLF	Estensibilità	Articolo
70 (20+50) x80	67-69,5/76-79	1200+1207+1721+1214
75 (25+50) x80	72-74,5/76-79	1201+1207+1721+1214
80 (30+50) x80	77-79,5/76-79	1202+1207+1721+1214
85 (20+65) x80	82-84,5/76-79	1200+1208+1721+1214
90 (20+70) x80	87-89,5/76-79	1200+1209+1721+1214
90 (25+65) x80	87-89,5/76-79	1201+1208+1721+1214
90 (40+50) x80	87-89,5/76-79	1203+1207+1721+1214
95 (25+70) x80	92-94,5/76-79	1201+1209+1721+1214
95 (30+65) x80	92-94,5/76-79	1202+1208+1721+1214
100 (20+80) x80	97-99,5/76-79	1200+1210+1721+1214
100 (30+70) x80	97-99,5/76-79	1202+1209+1721+1214
100 (50+50) x80	97-99,5/76-79	1204+1207+1721+1214
105 (25+80) x80	102-104,5/76-79	1201+1210+1721+1214
105 (40+65) x80	102-104,5/76-79	1203+1208+1721+1214
110 (30+80) x80	107-109,5/76-79	1202+1210+1721+1214
110 (40+70) x80	107-109,5/76-79	1203+1209+1721+1214
110 (60+50) x80	107-109,5/76-79	1205+1207+1721+1214
115 (50+65) x80	112-114,5/76-79	1204+1208+1721+1214
120 (40+80) x80	117-119,5/76-79	1203+1210+1721+1214
120 (50+70) x80	117-119,5/76-79	1204+1209+1721+1214
125 (60+65) x80	122-124,5/76-79	1205+1208+1721+1214
130 (50+80) x80	127-129,5/76-79	1204+1210+1721+1214
130 (60+70) x80	127-129,5/76-79	1205+1209+1721+1214
140 (60+80) x80	137-139,5/76-79	1205+1210+1721+1214
145 (60+85) x80	142-144,5/76-79	1205+1223+1721+1214

COMBI C + LATERALE FISSO 90 c/BRACCETTO 1214

Cm (F+A) xLF	Estensibilità	Articolo
70 (20+50) x90	67-69,5/86-89	1200+1207+1722+1214
75 (25+50) x90	72-74,5/86-89	1201+1207+1722+1214
80 (30+50) x90	77-79,5/86-89	1202+1207+1722+1214
85 (20+65) x90	82-84,5/86-89	1200+1208+1722+1214
90 (20+70) x90	87-89,5/86-89	1200+1209+1722+1214
90 (25+65) x90	87-89,5/86-89	1201+1208+1722+1214
90 (40+50) x90	87-89,5/86-89	1203+1207+1722+1214
95 (25+70) x90	92-94,5/86-89	1201+1209+1722+1214
95 (30+65) x90	92-94,5/86-89	1202+1208+1722+1214
100 (20+80) x90	97-99,5/86-89	1200+1210+1722+1214
100 (30+70) x90	97-99,5/86-89	1202+1209+1722+1214
100 (50+50) x90	97-99,5/86-89	1204+1207+1722+1214
105 (25+80) x90	102-104,5/86-89	1201+1210+1722+1214
105 (40+65) x90	102-104,5/86-89	1203+1208+1722+1214
110 (30+80) x90	107-109,5/86-89	1202+1210+1722+1214
110 (40+70) x90	107-109,5/86-89	1203+1209+1722+1214
110 (60+50) x90	107-109,5/86-89	1205+1207+1722+1214
115 (50+65) x90	112-114,5/86-89	1204+1208+1722+1214
120 (40+80) x90	117-119,5/86-89	1203+1210+1722+1214
120 (50+70) x90	117-119,5/86-89	1204+1209+1722+1214
125 (60+65) x90	122-124,5/86-89	1205+1208+1722+1214
130 (50+80) x90	127-129,5/86-89	1204+1210+1722+1214
130 (60+70) x90	127-129,5/86-89	1205+1209+1722+1214
140 (60+80) x90	137-139,5/86-89	1205+1210+1722+1214
145 (60+85) x90	142-144,5/86-89	1205+1223+1722+1214

OPEN FROST PLUS COMBI C + lat. fisso



laterali fissi FROST PLUS 6 mm

Descrizione	Estensibilità	Art.	
Lat. fisso frost plus 70x195	66-69	1292	
Lat. fisso frost plus 80x195	76-79	1293	
Lat. fisso frost plus 90x195	86-89	1294	
Braccetto Open		1214	

Descrizione	Articoli	
Profilo espansione +2 cm	0218	
Profilo espansione +4 cm	0029	
Profilo espansione +5,5 cm	0219	



Laterali fissi FROST PLUS su misura 6 mm (maggiori informazioni a pagina 282)

Descrizione	Art.		
Laterale fisso su misura OPEN fino 40 cm	1345+1312		
Laterale fisso su misura OPEN da 40 fino 80 cm	1316+1313		
Laterale fisso su misura OPEN da 80 fino 120 cm	1317+1315		

*Tempo di consegna 3 settimane.

**H195**

Altezza

**6mm**

Vetro



A battente 90°



Opzione 180°

**15 cm**

Espandibile



Reversibile

aluminio
AL
aluminium

clear shield glass

COMBI C + LATERALE FISSO 70 c/BRACCETTO 1214

Cm (F+A) xLF	Estensibilità	Articoli
80 (30+50) x70	77-79,5/66-69	1280+1284+1292+1214
85 (30+55) x70	82-84,5/66-69	1280+1285+1292+1214
90 (40+50) x70	87-89,5/66-69	1281+1284+1292+1214
95 (30+65) x70	92-94,5/66-69	1280+1287+1292+1214
100 (30+70) x70	97-99,5/66-69	1280+1288+1292+1214
100 (50+50) x70	97-99,5/66-69	1282+1284+1292+1214
105 (40+65) x70	102-104,5/66-69	1281+1287+1292+1214
110 (30+80) x70	107-109,5/66-69	1280+1290+1292+1214
110 (40+70) x70	107-109,5/66-69	1281+1288+1292+1214
110 (60+50) x70	107-109,5/66-69	1283+1284+1292+1214
115 (50+65) x70	112-114,5/66-69	1282+1287+1292+1214
120 (40+80) x70	117-119,5/66-69	1281+1290+1292+1214
120 (50+70) x70	117-119,5/66-69	1282+1288+1292+1214
125 (60+65) x70	122-124,5/66-69	1283+1287+1292+1214
130 (50+80) x70	127-129,5/66-69	1282+1290+1292+1214
130 (60+70) x70	127-129,5/66-69	1283+1288+1292+1214
135 (50+85) x70	132-134,5/66-69	1282+1291+1292+1214
140 (60+80) x70	137-139,5/66-69	1283+1290+1292+1214
145 (60+85) x70	142-144,5/66-69	1283+1291+1292+1214

Apertura esterna
90° p/fissoOpzione in-out
180° p/fisso

L'estensibilità del frontale con apertura in-out aumenterà di 1,4 cm e l'estensibilità del laterale fisso si riduce di 1 cm.
Art. 0038



Opzione barra 140 cm + supporto laterale fisso-Art. 1716+1718

COMBI C + LATERALE FISSO 80 c/BRACCETTO 1214

Cm (F+A) xLF	Estensibilità	Articoli
80 (30+50) x80	77-79,5/76-79	1280+1284+1293+1214
85 (30+55) x80	82-84,5/76-79	1280+1285+1293+1214
90 (40+50) x80	87-89,5/76-79	1281+1284+1293+1214
95 (30+65) x80	92-94,5/76-79	1280+1287+1293+1214
100 (30+70) x80	97-99,5/76-79	1280+1288+1293+1214
100 (50+50) x80	97-99,5/76-79	1282+1284+1293+1214
105 (40+65) x80	102-104,5/76-79	1281+1287+1293+1214
110 (30+80) x80	107-109,5/76-79	1280+1290+1293+1214
110 (40+70) x80	107-109,5/76-79	1281+1288+1293+1214
110 (60+50) x80	107-109,5/76-79	1283+1284+1293+1214
115 (50+65) x80	112-114,5/76-79	1282+1287+1293+1214
120 (40+80) x80	117-119,5/76-79	1281+1290+1293+1214
120 (50+70) x80	117-119,5/76-79	1282+1288+1293+1214
125 (60+65) x80	122-124,5/76-79	1283+1287+1293+1214
130 (50+80) x80	127-129,5/76-79	1282+1290+1293+1214
130 (60+70) x80	127-129,5/76-79	1283+1288+1293+1214
135 (50+85) x80	132-134,5/76-79	1282+1291+1293+1214
140 (60+80) x80	137-139,5/76-79	1283+1290+1293+1214
145 (60+85) x80	142-144,5/76-79	1283+1291+1293+1214

COMBI C + LATERALE FISSO 90 c/BRACCETTO 1214

Cm (F+A) xLF	Estensibilità	Articoli
80 (30+50) x90	77-79,5/86-89	1280+1284+1294+1214
85 (30+55) x90	82-84,5/86-89	1280+1285+1294+1214
90 (40+50) x90	87-89,5/86-89	1281+1284+1294+1214
95 (30+65) x90	92-94,5/86-89	1280+1287+1294+1214
100 (30+70) x90	97-99,5/86-89	1280+1288+1294+1214
100 (50+50) x90	97-99,5/86-89	1282+1284+1294+1214
105 (40+65) x90	102-104,5/86-89	1281+1287+1294+1214
110 (30+80) x90	107-109,5/86-89	1280+1290+1294+1214
110 (40+70) x90	107-109,5/86-89	1281+1288+1294+1214
110 (60+50) x90	107-109,5/86-89	1283+1284+1294+1214
115 (50+65) x90	112-114,5/86-89	1282+1287+1294+1214
120 (40+80) x90	117-119,5/86-89	1281+1290+1294+1214
120 (50+70) x90	117-119,5/86-89	1282+1288+1294+1214
125 (60+65) x90	122-124,5/86-89	1283+1287+1294+1214
130 (50+80) x90	127-129,5/86-89	1282+1290+1294+1214
130 (60+70) x90	127-129,5/86-89	1283+1288+1294+1214
135 (50+85) x90	132-134,5/86-89	1282+1291+1294+1214
140 (60+80) x90	137-139,5/86-89	1283+1290+1294+1214
145 (60+85) x90	142-144,5/86-89	1283+1291+1294+1214

OPEN COMBI D fisso + porta a battente con profilo a chiusura magnetica



Opzione barra 140 cm + soporte - Art. 1716

FISSI

Estensibilità cm	TRASPARENTE		FROST PLUS	
	Art.		Art.	
17,5/20	1200		-	
22,5/25	1201		-	
27,5/30	1202		1280	
37,5/40	1203		1281	
47,5/50	1204		1282	
57,5/60	1205		1283	

(2,5 regolazione)

Profilo a chiusura magnetica art.1212



Pannelli fissi su misura (vedi pag. 281)

PORTE

Estensibilità cm	TRASPARENTE		FROST PLUS	
	Art.		Art.	
42,5/45	1216+1212		-	
47,5/50	1217+1212		-	
52,5/55	1207+1212		1284+1212	
57,5/60	1218+1212		1285+1212	
62,5/65	1219+1212		1286+1212	
67,5/70	1208+1212		1287+1212	
72,5/75	1209+1212		1288+1212	
77,5/80	1220+1212		1289+1212	
82,5/85	1210+1212		1290+1212	
87,5/90	1223+1212		1291+1212	

(2,5 regolazione)



Abbinamenti con porte 50, 55, 65, 70, 80 e 85

COMBI D

Cm	Estensibilità	Fisso	Porta	Apert.
70	70-75	20	50	43
75	75-80	25	50	43
80	80-85	30	50	43
85	85-90	30	55	48
90	90-95	40	50	43
95	95-100	30	65	58
100	100-105	30	70	63
100	100-105	50	50	43
105	105-110	40	65	58
110	110-115	30	80	73
110	110-115	40	70	63
110	110-115	60	50	43
115	115-120	50	65	58
120	120-125	40	80	73
120	120-125	50	70	63
125	125-130	60	65	58
130	130-135	50	80	73
130	130-135	60	70	63
135	135-140	50	85	78
140	140-145	60	80	73
145	145-150	60	85	78

TRASPARENTE		FROST PLUS	
Articoli		Articoli	
1200+1207+1212		-	
1201+1207+1212		-	
1202+1207+1212		1280+1284+1212	
1202+1218+1212		1280+1285+1212	
1203+1207+1212		1281+1284+1212	
1202+1208+1212		1280+1287+1212	
1202+1209+1212		1280+1288+1212	
1204+1207+1212		1282+1284+1212	
1203+1208+1212		1281+1287+1212	
1202+1210+1212		1280+1290+1212	
1203+1209+1212		1281+1288+1212	
1205+1207+1212		1283+1284+1212	
1204+1208+1212		1282+1287+1212	
1203+1210+1212		1281+1290+1212	
1204+1209+1212		1282+1288+1212	
1205+1208+1212		1283+1287+1212	
1204+1210+1212		1282+1290+1212	
1205+1209+1212		1283+1288+1212	
1204+1223+1212		1282+1291+1212	
1205+1210+1212		1283+1290+1212	
1205+1223+1212		1283+1291+1212	

*Permette uso profilo di compensazione in entrambi i lati

*Permette combinazione con laterale fisso STD, estensibilità minima +0,7 / espansione 2,5 cm (vedi pag. 202)

Descrizione	Art.
Profilo espansione lato fisso +3 cm	0218
Profilo espansione lato fisso +6 cm	0029
Magnete espansione +1,2 cm, vedi pag. 285	1221
Opzione apertura IN-OUT 180°	1213

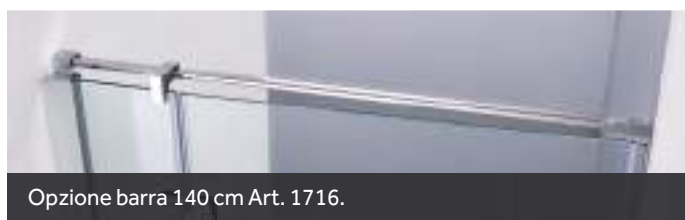

Opzione barra 140 cm Art. 1716.

OPEN COMBI E fisso + porta a battente con chiusura a fisso



Opzione barra 140 + soporte Art. 1716

COMBI E

FISSI	Estensibilità cm	Art.	
FISSO 20	17,5/20	1200	
FISSO 25	22,5/25	1201	
FISSO 30	27,5/30	1202	
FISSO 40	37,5/40	1203	
FISSO 50	47,5/50	1204	
FISSO 60	57,5/60	1205	

(2,5 regolazione)

Profilo parete art. 1211



Pannelli fissi su misura (vedi pag. 281)

PORTE	Estensibilità cm	Art.	
PORTA 40	41,1/42,6	1216 + 1211	
PORTA 45	46,1/47,6	1217 + 1211	
PORTA 50	51,1/52,6	1207 + 1211	
PORTA 55	56,1/57,6	1218 + 1211	
PORTA 60	61,1/62,6	1219 + 1211	
PORTA 65	66,1/67,6	1208 + 1211	
PORTA 70	71,1/72,6	1209 + 1211	
PORTA 75	76,1/77,6	1220 + 1211	
PORTA 80	81,1/82,6	1210 + 1211	
PORTA 85	86,1/87,6	1223 + 1211	

(1,5 regolazione)



COMBI E

Abbinamenti con porte 50, 65, 70 e 80

Cm	Estensibilità	Fisso	Porta	Apertura	Articolo
70	68,6-72,6	20	50	43	1200+1207+1211
75	73,6-77,6	25	50	43	1201+1207+1211
80	78,6-82,6	30	50	43	1202+1207+1211
85	83,6-87,6	20	65	58	1200+1208+1211
90	88,6-92,6	40	50	43	1203+1207+1211
90	88,6-92,6	25	65	58	1201+1208+1211
90	88,6-92,6	20	70	63	1200+1209+1211
95	93,6-97,6	25	70	63	1201+1209+1211
95	93,6-97,6	30	65	58	1202+1208+1211
100	98,6-102,6	30	70	63	1202+1209+1211
100	98,6-102,6	20	80	73	1200+1210+1211
100	98,6-102,6	50	50	43	1204+1207+1211
105	103,6-107,6	25	80	73	1201+1210+1211
105	103,6-107,6	40	65	58	1203+1208+1211
110	108,6-112,6	30	80	73	1202+1210+1211
110	108,6-112,6	40	70	63	1203+1209+1211
110	108,6-112,6	60	50	43	1205+1207+1211
115	113,6-117,6	50	65	58	1204+1208+1211
120	118,6-122,6	40	80	73	1203+1210+1211
120	118,6-122,6	50	70	63	1204+1209+1211
125	123,6-127,6	60	65	58	1205+1208+1211
130	128,6-132,6	50	80	73	1204+1210+1211
130	128,6-132,6	60	70	63	1205+1209+1211
135	133,6-137,6	50	85	78	1204+1223+1211
140	138,6-142,6	60	80	73	1205+1210+1211
145	143,6-147,6	60	85	78	1205+1223+1211

*Permette combinazione con laterale fisso STD nel lato fisso, estensione minima +0,7 / espansione 1,5 cm (vedi pag. 202)

*Permette unione Laterale fisso STD nel lato porta usando art. 1222, estensione minima +1,8 cm / espansione 2,5 cm (vedi pag. 202)

Descrizione	Ref
Profilo espansione lato fisso +3 cm	0218
Profilo espansione lato fisso +6 cm	0029
Profilo porta (riduce fino 1 cm l'estensione), vedi pag. 285	1215
Magnete espansione +1,2 cm, vedi pag. 285	1221
Profilo espansione porte +2,5 cm, vedi pag. 285	1222
Opzione apertura IN-OUT 180°	1213

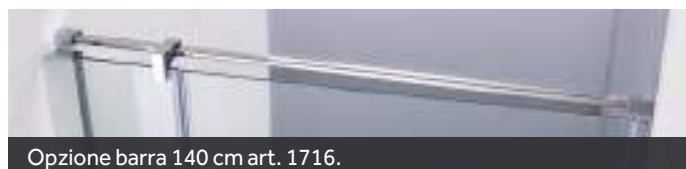

Opzione barra 140 cm art. 1716.



OPEN COMBI F fisso + porta + fisso



Opzione barra 140 cm, art. 1716
Opzione barra 200 cm, art. 1717

COMBI F

FISSI	Estensibilità cm	Art.	PORTE	Misura cm	Art.
FISSO 20	17,5/20	1200	PORTA 40	40	1216
FISSO 25	22,5/25	1201	PORTA 45	45	1217
FISSO 30	27,5/30	1202	PORTA 50	50	1207
FISSO 40	37,5/40	1203	PORTA 55	55	1218
FISSO 50	47,5/50	1204	PORTA 60	60	1219
FISSO 60	57,5/60	1205	PORTA 65	65	1208
(regolazione 2,5x2 = 5cm)			PORTA 70	70	1209
			PORTA 75	75	1220
			PORTA 80	80	1210
			PORTA 85	85	1223



Pannelli fissi su misura
(vedi pag. 281)



COMBI F Combinazione di porte 50, 65, 70 e 80

Cm (F+P+F)	Articoli	Ap.	Estensibilità
90 (20+50+20)	1200+1207+1200	43	85-90
95 (20+50+25)	1200+1207+1201	43	90-95
100 (25+50+25)	1201+1207+1201	43	95-100
100 (20+50+30)	1200+1207+1202	43	95-100
105 (25+50+30)	1201+1207+1202	43	100-105
105 (20+65+20)	1200+1208+1200	58	100-105
110 (20+65+25)	1200+1208+1201	58	105-110
110 (20+70+20)	1200+1209+1200	63	105-110
110 (30+50+30)	1202+1207+1202	43	105-110
115 (20+65+30)	1200+1208+1202	58	110-115
115 (20+70+25)	1200+1209+1201	63	110-115
120 (30+50+40)	1202+1207+1203	43	115-120
120 (25+65+30)	1201+1208+1202	58	115-120
120 (20+70+30)	1200+1209+1202	63	115-120
120 (20+80+20)	1200+1210+1200	73	115-120
125 (20+65+40)	1200+1208+1203	58	120-125
125 (30+65+30)	1202+1208+1202	58	120-125
125 (25+70+30)	1201+1209+1202	63	120-125
125 (25+80+20)	1201+1210+1200	73	120-125
130 (25+65+40)	1201+1208+1203	58	125-130
130 (20+70+40)	1200+1209+1203	63	125-130
130 (30+70+30)	1202+1209+1202	63	125-130
130 (20+80+30)	1200+1210+1202	73	125-130
130 (20+50+60)	1200+1207+1205	43	125-130
135 (20+65+50)	1200+1208+1204	58	130-135
135 (30+65+40)	1202+1208+1203	58	130-135
135 (25+70+40)	1201+1209+1203	63	130-135
135 (25+80+30)	1201+1210+1202	73	130-135
135 (25+50+60)	1201+1207+1205	43	130-135
140 (25+65+50)	1201+1208+1204	58	135-140
140 (20+70+50)	1200+1209+1204	63	135-140
140 (30+70+40)	1202+1209+1203	63	135-140
140 (20+80+40)	1200+1210+1203	73	135-140
140 (30+80+30)	1202+1210+1202	73	135-140
140 (30+50+60)	1202+1207+1205	43	135-140
145 (30+65+50)	1202+1208+1204	58	140-145
145 (40+65+40)	1203+1208+1203	58	140-145

COMBI F Combinazione di porte 50, 65, 70 e 80

Cm (F+P+F)	Articoli	Ap.	Estensibilità
145 (25+70+50)	1201+1209+1204	63	140-145
145 (25+80+40)	1201+1210+1203	73	140-145
145 (20+65+60)	1200+1208+1205	58	140-145
150 (40+50+60)	1203+1207+1205	43	145-150
150 (25+65+60)	1201+1208+1205	58	145-150
150 (20+70+60)	1200+1209+1205	63	145-150
150 (30+70+50)	1202+1209+1204	63	145-150
150 (40+70+40)	1203+1209+1203	63	145-150
150 (30+80+40)	1202+1210+1203	73	145-150
150 (20+80+50)	1200+1210+1204	73	145-150
155 (30+65+60)	1202+1208+1205	58	150-155
155 (25+70+60)	1201+1209+1205	63	150-155
155 (40+65+50)	1203+1208+1204	58	150-155
155 (25+80+50)	1201+1210+1204	73	150-155
160 (50+50+60)	1204+1207+1205	43	155-160
160 (30+70+60)	1202+1209+1205	63	155-160
160 (40+70+50)	1203+1209+1204	63	155-160
160 (30+80+50)	1202+1210+1204	73	155-160
160 (20+80+60)	1200+1210+1205	73	155-160
160 (40+80+40)	1203+1210+1203	73	155-160
165 (40+65+60)	1203+1208+1205	58	160-165
165 (50+65+50)	1204+1208+1204	58	160-165
165 (25+80+60)	1201+1210+1205	73	160-165
170 (60+50+60)	1205+1207+1205	43	165-170
170 (40+70+60)	1203+1209+1205	63	165-170
170 (50+70+50)	1204+1209+1204	63	165-170
170 (30+80+60)	1202+1210+1205	73	165-170
170 (40+80+50)	1203+1210+1204	73	165-170
175 (50+65+60)	1204+1208+1205	58	170-175
180 (50+70+60)	1204+1209+1205	63	175-180
180 (40+80+60)	1203+1210+1205	73	175-180
180 (50+80+50)	1204+1210+1204	73	175-180
185 (60+65+60)	1205+1208+1205	58	180-185
190 (60+70+60)	1205+1209+1205	63	185-190
190 (50+80+60)	1204+1210+1205	73	185-190
200 (60+80+60)	1205+1210+1205	73	195-200

*Permette unione con laterale fisso STD in entrambi i lati (estens.minima +0,7 cm / regol. 2,5 cm), vedi pag. 202.

*Permette uso profilo di compensazione in entrambi i lati

Descrizione	Art.
Profilo espansione lato fisso +3 cm	0218
Profilo espansione lato fisso +6 cm	0029
Magnete espansione +1,2 cm, vedi pag. 285	1221
Opzione apertura IN-OUT 180°	1213

OPEN COMBI G fisso + 2 porte a battente + fisso

Nero
Vedi pag. 219



Opzione barra 200 + supporti Art. 1717
Aumenta di 120 p

FISSI

Estensibilità cm	TRASPARENTE		FROST PLUS	
	Art.		Art.	
17,5/20	1200		-	
22,5/25	1201		-	
27,5/30	1202		1280	
37,5/40	1203		1281	
47,5/50	1204		1282	
57,5/60	1205		1283	

(regolazione 2,5x2 = 5cm)



Pannelli fissi su misura (vedi pag. 281)

PORTE

Misura cm	TRASPARENTE		FROST PLUS	
	Art.	P	Art.	
2 PORTE 76,2	1206	602	-	
38,1	1216	356	-	
43,1	1217	366	-	
48,1	1207	375	1284	
53,1	1218	389	1285	
58,1	1219	401	1286	
63,1	1208	408	1287	
68,1	1209	423	1288	
73,1	1220	446	1289	
78,1	1210	453	1290	
83,1	1223	468	1291	

COMBI G

Abbinamenti con porte 50, 65, 70 e 80

Cm (F+P+P+F)	Estensibilità	Articoli	
115 (20+40+40+20)	111,2-116,2	1200x2+1206	
120 (20+40+40+25)	116,2-121,2	1200+1201+1206	
125 (20+40+40+30)	121,2-126,2	1200+1202+1206	
125 (25+40+40+25)	121,2-126,2	1201x2+1206	
130 (25+40+40+30)	126,2-131,2	1201+1202+1206	
135 (20+50+50+20)	131,2-136,2	1200x2+1207x2	
135 (30+40+40+30)	131,2-136,2	1202x2+1206	
140 (25+40+40+40)	136,2-141,2	1201+1203+1206	
140 (20+50+50+25)	136,2-141,2	1200+1201+1207x2	
145 (20+50+50+30)	141,2-146,2	1200+1202+1207x2	
145 (30+40+40+40)	141,2-146,2	1202+1203+1206	
150 (25+50+50+30)	146,2-151,2	1201+1202+1207x2	
150 (25+40+40+50)	146,2-151,2	1201+1204+1206	

COMBI G

Abbinamenti con porte 50, 65, 70 e 80

Cm (F+P+P+F)	Estensibilità	Articoli	
155 (20+50+50+40)	151,2-156,2	1200+1203+1207x2	
155 (30+50+50+30)	151,2-156,2	1202x2+1207x2	
155 (40+40+40+40)	151,2-156,2	1203x2+1206	
155 (20+40+40+60)	151,2-156,2	1200+1205+1206	
160 (25+40+40+60)	156,2-161,2	1201+1205+1206	
160 (25+50+50+40)	156,2-161,2	1201+1203+1207x2	
165 (30+40+40+60)	161,2-166,2	1202+1205+1206	
165 (30+50+50+40)	161,2-166,2	1202+1203+1207x2	
165 (20+65+65+20)	161,2-166,2	1200x2+1208x2	
165 (40+40+40+50)	161,2-166,2	1203+1204+1206	
170 (20+65+65+25)	166,2-171,2	1200+1201+1208x2	
175 (40+40+40+60)	171,2-176,2	1203+1205+1206	
175 (30+50+50+50)	171,2-176,2	1202+1204+1207x2	

COMBI G

Abbinamenti con porte 50, 65, 70 e 80

Cm (F+P+P+F)	Estensibilità	Articoli
175 (40+50+50+40)	171,2-176,2	1203x2+1207x2
175 (20+50+50+60)	171,2-176,2	1200+1205+1207x2
175 (20+65+65+30)	171,2-176,2	1200+1202+1208x2
175 (20+70+70+20)	171,2-176,2	1200x2+1209x2
175 (50+40+40+50)	171,2-176,2	1204x2+1206
180 (25+50+50+60)	176,2-181,2	1201+1205+1207x2
180 (25+65+65+30)	176,2-181,2	1201+1202+1208x2
180 (20+70+70+25)	176,2-181,2	1200+1201+1209x2
185 (50+40+40+60)	181,2-186,2	1204+1205+1206
185 (40+50+50+50)	181,2-186,2	1203+1204+1207x2
185 (30+50+50+60)	181,2-186,2	1202+1205+1207x2
185 (30+65+65+30)	181,2-186,2	1202x2+1208x2
185 (25+70+70+25)	181,2-186,2	1201x2+1209x2
185 (20+70+70+30)	181,2-186,2	1200+1202+1209x2
190 (25+65+65+40)	186,2-191,2	1201+1203+1208x2
190 (25+70+70+30)	186,2-191,2	1201+1202+1209x2
195 (60+40+40+60)	191,2-196,2	1205x2+1206
195 (50+50+50+50)	191,2-196,2	1204x2+1207x2
195 (40+50+50+60)	191,2-196,2	1203+1205+1207x2
195 (20+65+65+50)	191,2-196,2	1200+1204+1208x2
195 (30+65+65+40)	191,2-196,2	1202+1203+1208x2
195 (30+70+70+30)	191,2-196,2	1202x2+1209x2
195 (20+70+70+40)	191,2-196,2	1200+1203+1209x2
195 (20+80+80+20)	191,2-196,2	1200x2+1210x2
200 (25+65+65+50)	196,2-201,2	1201+1204+1208x2
200 (25+70+70+40)	196,2-201,2	1201+1203+1209x2
200 (25+80+80+20)	196,2-201,2	1201+1200+1210x2
205 (20+65+65+60)	201,2-206,2	1200+1205+1208x2
205 (40+65+65+40)	201,2-206,2	1203x2+1208x2
205 (30+65+65+50)	201,2-206,2	1202+1204+1208x2
205 (30+70+70+40)	201,2-206,2	1202+1203+1209x2
205 (20+70+70+50)	201,2-206,2	1200+1204+1209x2
205 (50+50+50+60)	201,2-206,2	1204+1205+1207x2
205 (20+80+80+30)	201,2-206,2	1200+1202+1210x2
210 (25+65+65+60)	206,2-211,2	1201+1205+1208x2
210 (25+70+70+50)	206,2-211,2	1201+1204+1209x2
210 (25+80+80+30)	206,2-211,2	1201+1202+1210x2

COMBI G

Abbinamenti con porte 50, 65, 70 e 80

Cm (F+P+P+F)	Estensibilità	Articoli
215 (30+65+65+60)	211,2-216,2	1202+1205+1208x2
215 (40+65+65+50)	211,2-216,2	1203+1204+1208x2
215 (20+70+70+60)	211,2-216,2	1200+1205+1209x2
215 (30+70+70+50)	211,2-216,2	1202+1204+1209x2
215 (40+70+70+40)	211,2-216,2	1203x2+1209x2
215 (30+80+80+30)	211,2-216,2	1202x2+1210x2
215 (20+80+80+40)	211,2-216,2	1200+1203+1210x2
215 (25+70+70+60)	216,2-221,2	1201+1205+1209x2
215 (60+50+50+60)	211,2-216,2	1205x2+1207x2
220 (25+80+80+40)	216,2-221,2	1201+1203+1210x2
225 (50+65+65+50)	221,2-226,2	1204x2+1208x2
225 (40+65+65+60)	221,2-226,2	1203+1205+1208x2
225 (30+70+70+60)	221,2-226,2	1202+1205+1209x2
225 (40+70+70+50)	221,2-226,2	1203+1204+1209x2
225 (20+80+80+50)	221,2-226,2	1200+1204+1210x2
225 (30+80+80+40)	221,2-226,2	1202+1203+1210x2
230 (25+80+80+50)	226,2-231,2	1201+1204+1210x2
235 (50+65+65+60)	231,2-236,2	1204+1205+1208x2
235 (40+70+70+60)	231,2-236,2	1203+1205+1209x2
235 (50+70+70+50)	231,2-236,2	1204x2+1209x2
235 (20+80+80+60)	231,2-236,2	1200+1205+1210x2
235 (40+80+80+40)	231,2-236,2	1203x2+1210x2
240 (25+80+80+60)	236,2-241,2	1201+1205+1210x2
245 (60+65+65+60)	241,2-246,2	1205x2+1208x2
245 (50+70+70+60)	241,2-246,2	1204+1205+1209x2
245 (30+80+80+60)	241,2-246,2	1202+1205+1210x2
245 (40+80+80+50)	241,2-246,2	1203+1204+1210x2
255 (60+70+70+60)	251,2-256,2	1205x2+1209x2
255 (40+80+80+60)	251,2-256,2	1203+1205+1210x2
255 (50+80+80+50)	251,2-256,2	1204x2+1210x2
265 (50+80+80+60)	261,2-266,2	1204+1205+1210x2
275 (60+80+80+60)	271,2-276,2	1205x2+1210x2

**Combinazioni
FROST PLUS**

*Permette unione con laterale fisso STD in entrambi i lati (estens.minima +0,7 cm / regol. 2,5 cm), vedi pag. 202.

*Permette uso profilo di compensazione in entrambi i lati

Descrizione	Art.
Profilo espansione lato fisso +3 cm	0218
Profilo espansione lato fisso +6 cm	0029
Magnete espansione +1,2 cm, vedi pag. 285	1221

OPEN COMBI H angolare 2 porte a battente + 2 fissi



Opzione barra + supporti Art. 1716x2+1730

FISSI

Estensibilità cm	TRASPARENTE		FROST PLUS	
	Art.		Art.	
17,5/20	1200		-	
22,5/25	1201		-	
27,5/30	1202		1280	
37,5/40	1203		1281	
47,5/50	1204		1282	
57,5/60	1205		1283	

(2,5 regolazione)



Pannelli fissi su misura (vedi pag. 281)

PORTE

Misura cm	TRASPARENTE		FROST PLUS	
	Art.	P	Art.	
2 PORTE 76,2	1206	602	-	
39,5	1216	356	-	
44,5	1217	366	-	
49,5	1207	375	1284	
54,5	1218	389	1285	
59,5	1219	401	1286	
64,5	1208	408	1287	
69,5	1209	423	1288	
74,5	1220	446	1289	
79,5	1210	453	1290	
84,5	1223	468	1291	

(non regolabile)



COMBI H

Abbinamenti con porte 40, 50, 65, 70 e 80

Cm (F+P+P+F)	Estensibilità	Articoli
70x70(30+40+40+30)	67-69,5	1202x2+1206
70X70(20+50+50+20)	67-69,5	1200x2+1207x2
75X75(25+50+50+25)	72-74,5	1201x2+1207x2
80x80(40+40+40+40)	77-79,5	1203x2+1206
80X80(30+50+50+30)	77-79,5	1202x2+1207x2
85x85(20+65+65+20)	82-85,5	1200x2+1208x2
90x90(50+40+40+50)	87-89,5	1204x2+1206
90x90(40+50+50+40)	87-89,5	1203x2+1207x2
90x90(25+65+65+25)	87-89,5	1201x2+1208x2
90x90(20+70+70+20)	87-89,5	1200x2+1209x2
95x95(30+65+65+30)	92-94,5	1202x2+1208x2
100x100(60+40+40+60)	97-99,5	1205x2+1206
100x100(30+70+70+30)	97-99,5	1202x2+1209x2
100x100(50+50+50+50)	97-99,5	1204x2+1207x2
90x70(50+40+40+30)	87-89,5 / 67-69,5	1204+1202+1206
90x70(40+50+50+20)	87-89,5 / 67-69,5	1203+1200+1207x2
90x70(25+65+50+20)	87-89,5 / 67-69,5	1201+1208+1200+1207
90x70(20+70+50+20)	87-89,5 / 67-69,5	1200x2+1209+1207
95x70(30+65+50+20)	92-94,5 / 67-69,5	1202+1208+1200+1207
95x70(25+70+50+20)	92-94,5 / 67-69,5	1201+1209+1200+1207
100x70(60+40+40+30)	97-99,5 / 67-69,5	1205+1202+1206
100x70(30+70+50+20)	97-99,5 / 67-69,5	1202+1209+1200+1207
100x70(20+80+50+20)	97-99,5 / 67-69,5	1200x2+1210+1207
105x70(40+65+50+20)	102-104,5 / 67-69,5	1203+1208+1200+1207
105x70(25+80+50+20)	102-104,5 / 67-69,5	1201+1210+1200+1207
110x70(40+70+50+20)	107-109,5 / 67-69,5	1203+1209+1200+1207
110x70(30+80+50+20)	107-109,5 / 67-69,5	1202+1210+1200+1207
110x70(60+50+50+20)	107-109,5 / 67-69,5	1205+1207+1200+1207
115x70(50+65+50+20)	112-114,5 / 67-69,5	1204+1208+1200+1207
120x70(50+70+50+20)	117-119,5 / 67-69,5	1204+1209+1200+1207
120x70(40+80+50+20)	117-119,5 / 67-69,5	1203+1210+1200+1207

*Permette uso profilo di compensazione in entrambi i lati

Descrizione	Art.
Profilo espansione lato fisso +3 cm	0218
Profilo espansione lato fisso +6 cm	0029

COMBI H

Abbinamenti con porte 40, 50, 65, 70 e 80

Cm (F+P+P+F)	Estensibilità	Articoli
125x70(60+65+50+20)	122-124,5 / 67-69,5	1205+1208+1200+1207
130x70(50+80+50+20)	127-129,5 / 67-69,5	1204+1210+1200+1207
130x70(60+70+50+20)	127-129,5 / 67-69,5	1205+1209+1200+1207
140x70(60+80+50+20)	137-139,4 / 67-69,5	1205+1210+1200+1207
90x80(50+40+40+40)	87-89,5 / 77-79,5	1204+1203+1206
90x80(40+50+50+30)	87-89,5 / 77-79,5	1203+1202+1207x2
90x80(25+65+50+30)	87-89,5 / 77-79,5	1201+1208+1202+1207
90x80(20+70+50+30)	87-89,5 / 77-79,5	1200+1209+1207+1202
95x80(30+65+50+30)	92-94,5 / 77-79,5	1202+1208+1202+1207
95x80(25+70+50+30)	92-94,5 / 77-79,5	1201+1209+1202+1207
100x80(60+40+40+40)	97-99,5 / 77-79,5	1205+1203+1206
100x80(30+70+50+30)	97-99,5 / 77-79,5	1202+1209+1202+1207
100x80(20+80+50+30)	97-99,5 / 77-79,5	1210+1200+1202+1207
105x80(40+65+50+30)	102-104,5 / 77-79,5	1203+1208+1202+1207
105x80(25+80+50+30)	102-104,5 / 77-79,5	1201+1210+1202+1207
110X80(60+50+50+30)	107-109,5 / 77-79,5	1205+1207+1202+1207
110X80(40+70+50+30)	107-109,5 / 77-79,5	1203+1209+1202+1207
110X80(30+80+50+30)	107-109,5 / 77-79,5	1202x2+1210+1207
115X80(50+65+50+30)	112-114,5 / 77-79,5	1204+1208+1202+1207
120x80(50+70+50+30)	117-119,5 / 77-79,5	1204+1209+1202+1207
120x80(40+80+50+30)	117-119,5 / 77-79,5	1203+1210+1202+1207
125x80(60+65+50+30)	122-124,5 / 77-79,5	1205+1208+1202+1207
130x80(50+80+50+30)	127-129,5 / 77-79,5	1204+1210+1202+1207
130x80(60+70+50+30)	127-129,5 / 77-79,5	1205+1209+1202+1207
140x80(60+80+50+30)	137-139,5 / 77-79,5	1205+1210+1202+1207
95x90(30+65+50+40)	92-94,5 / 87-89,5	1202+1208+1203+1207
95x90(25+70+50+40)	92-94,5 / 87-89,5	1201+1209+1203+1207
95x90(30+65+65+25)	92-94,5 / 87-89,5	1202+1201+1208x2
95x90(25+70+65+25)	92-94,5 / 87-89,5	1201+1209+1201+1208
95x90(30+65+70+20)	92-94,5 / 87-89,5	1202+1208+1200+1209
95x90(25+70+70+20)	92-94,5 / 87-89,5	1201+1200+1209x2

Combinazioni FROST PLUS

OPEN COMBI H angolare 2 porte a battente + 2 fissi



FISSI

Estens. cm	TRASPARENTE		FROST PLUS	
	Art.		Art.	
17,5/20	1200		-	
22,5/25	1201		-	
27,5/30	1202		1280	
37,5/40	1203		1281	
47,5/50	1204		1282	
57,5/60	1205		1283	

(2,5 regolazione)



Pannelli fissi su misura (vedi pag. 281)

PORTE

Misura cm	TRASPARENTE		FROST PLUS	
	Art.		Art.	
2 PORTE 76,2	1206		-	
39,5	1216		-	
44,5	1217		-	
49,5	1207		1284	
54,5	1218		1285	
59,5	1219		1286	
64,5	1208		1287	
69,5	1209		1288	
74,5	1220		1289	
79,5	1210		1290	
84,5	1223		1291	

(non regolabile)



Vedi pag. 221

COMBI H

Abbinamenti con porte 40, 50, 65, 70 e 80

Cm (F+P+P+F)	Estensibilità	Articoli
100x90(60+40+40+50)	97-99,5 / 87-89,5	1205+1204+1206
100x90(30+70+50+40)	97-99,5 / 87-89,5	1202+1209+1203+1207
100x90(20+80+50+40)	97-99,5 / 87-89,5	1200+1210+1203+1207
100x90(30+70+65+25)	97-99,5 / 87-89,5	1202+1209+1201+1208
100x90(20+80+65+25)	97-99,5 / 87-89,5	1200+1210+1201+1208
100x90(30+70+70+20)	97-99,5 / 87-89,5	1202+1200+1209x2
100x90(20+80+70+20)	97-99,5 / 87-89,5	1200x2+1210+1209
105x90(40+65+50+40)	102-104,5 / 87-89,5	1203x2+1208+1207
105x90(25+80+50+40)	102-104,5 / 87-89,5	1201+1210+1203+1207
105x90(40+65+65+25)	102-104,5 / 87-89,5	1203+1201+1208x2
105x90(25+80+65+25)	102-104,5 / 87-89,5	1201x2+1210+1208
105x90(40+65+70+20)	102-104,5 / 87-89,5	1203+1208+1200+1209
105x90(25+80+70+20)	102-104,5 / 87-89,5	1201+1210+1200+1209
110x90(60+50+50+40)	107-109,5 / 87-89,5	1205+1203+1207x2
110x90(40+70+50+40)	107-109,5 / 87-89,5	1203x2+1209+1207
110x90(30+80+50+40)	107-109,5 / 87-89,5	1202+1210+1203+1207
110x90(60+50+65+25)	107-109,5 / 87-89,5	1205+1207+1201+1208
110x90(40+70+65+25)	107-109,5 / 87-89,5	1203+1209+1201+1208
110x90(30+80+65+25)	107-109,5 / 87-89,5	1202+1210+1201+1208
110x90(60+50+70+20)	107-109,5 / 87-89,5	1205+1207+1200+1209
110x90(40+70+70+20)	107-109,5 / 87-89,5	1203+1200+1209x2
110x90(30+80+70+20)	107-109,5 / 87-89,5	1202+1210+1200+1209

COMBI H

Abbinamenti con porte 40, 50, 65, 70 e 80

Cm (F+P+P+F)	Estensibilità	Articoli
115x90(50+65+50+40)	112-114,5 / 87-89,5	1204+1208+1203+1207
115x90(50+65+65+25)	112-114,5 / 87-89,5	1204+1201+1208x2
115x90(50+65+70+20)	112-114,5 / 87-89,5	1204+1208+1200+1209
120x90(50+70+50+40)	117-119,5 / 87-89,5	1204+1209+1203+1207
120x90(40+80+50+40)	117-119,5 / 87-89,5	1203x2+1210+1207
120x90(50+70+65+25)	117-119,5 / 87-89,5	1204+1209+1201+1208
120x90(40+80+65+25)	117-119,5 / 87-89,5	1203+1210+1201+1208
120x90(50+70+70+20)	117-119,5 / 87-89,5	1204+1200+1209x2
120x90(40+80+70+20)	117-119,5 / 87-89,5	1203+1210+1200+1209
125x90(60+65+50+40)	122-124,5 / 87-89,5	1205+1208+1203+1207
125x90(60+65+65+25)	122-124,5 / 87-89,5	1205+1201+1208x2
125x90(60+65+70+20)	122-124,5 / 87-89,5	1205+1208+1200+1209
130x90(60+70+50+40)	127-129,5 / 87-89,5	1205+1209+1203+1207
130x90(50+80+50+40)	127-129,5 / 87-89,5	1204+1210+1203+1207
130x90(60+70+65+25)	127-129,5 / 87-89,5	1205+1209+1201+1208
130x90(50+80+65+25)	127-129,5 / 87-89,5	1204+1210+1201+1208
130x90(60+70+70+20)	127-129,5 / 87-89,5	1205+1200+1209x2
130x90(50+80+70+20)	127-129,5 / 87-89,5	1204+1210+1200+1209
140x90(60+80+50+40)	137-139,5 / 87-89,5	1205+1210+1203+1207
140x90(60+80+65+25)	137-139,5 / 87-89,5	1205+1210+1201+1208
140x90(60+80+70+20)	137-139,5 / 87-89,5	1205+1210+1200+1209

*Permette uso profilo di compensazione in entrambi i lati

Descrizione	Art.
Profilo espansione lato fisso +3 cm	0218
Profilo espansione lato fisso +6 cm	0029

Combinazioni FROST PLUS



Opzione barra + supporti Art. 1716x2+1730

OPEN COMBI I 2 porte a battente





COMBI I

Cm	Estensibilità	Apert.	TRASPARENTE		FROST PLUS	
			Articoli		Articoli	
80 (40+40)	79-82	66	1206+1211x2		-	
85 (40+45)	84-87	71	1216+1217+1211x2		-	
90 (45+45)	89-92	76	1217x2+1211x2		-	
95 (45+50)	94-97	81	1217+1207+1211x2		-	
100 (50+50)	99-102	86	1207x2+1211x2		1284x2+1211x2	
105 (50+55)	104-107	91	1207+1218+1211x2		1284+1285+1211x2	
110 (55+55)	109-112	96	1218x2+1211x2		1285x2+1211x2	
115 (55+60)	114-117	101	1218+1219+1211x2		1285+1286+1211x2	
120 (60+60)	119-122	106	1219x2+1211x2		1286x2+1211x2	
125 (60+65)	124-127	111	1219+1208+1211x2		1286+1287+1211x2	
130 (65+65)	129-132	116	1208x2+1211x2		1287x2+1211x2	
135 (65+70)	134-137	121	1208+1209+1211x2		1287+1288+1211x2	
140 (70+70)	139-142	126	1209x2+1211x2		1288x2+1211x2	
145 (70+75)	144-147	131	1209+1220+1211x2		1288+1289+1211x2	
150 (75+75)	149-152	136	1220x2+1211x2		1289x2+1211x2	
155 (75+80)	154-157	141	1220+1210+1211x2		1289+1290+1211x2	
160 (80+80)	159-162	146	1210x2+1211x2		1290x2+1211x2	
165 (80+85)	164-167	151	1210+1223+1211x2		1290+1291+1211x2	
170 (85+85)	169-172	156	1223x2+1211x2		1291x2+1211x2	

*Permette unione con laterale fisso STD con art. 1222 (estensibilità minima +1,8/ espansione 1,5), vedi pag. 202.

Descrizione	Art.
Magnete espansione +1,2 cm, vedi pag. 285	1221
Profilo espansione porte +2,5 cm, vedi pag. 285	1222
Profilo porta (riduce fino 1 cm l'estensione), vedi pag. 285	1215

OPEN COMBI J 2 porte a battente + fisso



FISSI

Estens. cm	TRASPARENTE		FROST PLUS	
	Art.		Art.	
17,5/20	1200		-	
22,5/25	1201		-	
27,5/30	1202		1280	
37,5/40	1203		1281	
47,5/50	1204		1282	
57,5/60	1205		1283	

(2,5 regolazione)

Profilo porta art. 1211



Pannelli fissi su misura (vedi pag. 281)

PORTE

Misura cm	TRASPARENTE		FROST PLUS	
	Art.		Art.	
2 PORTE 76,2	1206		-	
38,6	1216		-	
43,6	1217		-	
48,6	1207		1284	
53,6	1218		1285	
58,6	1219		1286	
63,6	1208		1287	
68,6	1209		1288	
73,6	1220		1289	
78,6	1210		1290	
83,6	1223		1291	

(1,5 regolazione)



COMBI J

Cm (P+P+F)	Estensibilità	Apert.	TRASPARENTE		FROST PLUS	
			Articoli		Articoli	
95 (40+40+20)	94,8/98,8	66	1206+1200+1211		-	
100 (40+40+25)	99,8/103,8	66	1206+1201+1211		-	
105 (40+40+30)	104,8/108,8	66	1206+1202+1211		-	
110 (45+45+25)	109,8/113,8	76	1217X2+1201+1211		-	
115 (45+45+30)	114,8/118,8	76	1217X2+1202+1211		-	
120 (50+50+25)	119,8/123,8	86	1207X2+1201+1211		-	
125 (50+50+30)	124,8/128,8	86	1207X2+1202+1211		1284X2+1280+1211	
130 (50+55+30)	129,8/133,8	91	1207+1218+1202+1211		1284+1285+1280+1211	
135 (50+50+40)	134,8/138,8	86	1207X2+1203+1211		1284X2+1281+1211	
140 (60+55+30)	139,8/143,8	101	1219+1218+1202+1211		1286+1285+1280+1211	
145 (45+45+60)	144,8/148,8	76	1217X2+1205+1211		-	
145 (50+50+50)	144,8/148,8	86	1207X2+1204+1211		1284X2+1282+1211	
145 (60+60+30)	144,8/148,8	106	1219X2+1202+1211		1286X2+1280+1211	
155 (55+55+50)	154,8/158,8	96	1218X2+1204+1211		1285X2+1282+1211	
160 (60+55+50)	159,8/163,8	101	1219+1218+1204+1211		1286+1285+1282+1211	
165 (65+65+40)	164,8/168,8	116	1208X2+1203+1211		1287X2+1281+1211	
170 (75+70+30)	169,8/173,8	131	1220+1209+1202+1211		1289+1288+1280+1211	
175 (75+75+30)	174,8/178,8	136	1220X2+1202+1211		1289X2+1280+1211	
180 (80+75+30)	179,8/183,8	141	1210+1220+1202+1211		1290+1289+1280+1211	
185 (80+80+30)	184,8/188,8	146	1210X2+1202+1211		1290X2+1280+1211	
190 (65+70+60)	189,8/193,8	121	1208+1209+1205+1211		1287+1288+1283+1211	
195 (75+75+50)	194,8/198,8	136	1220X2+1204+1211		1289X2+1282+1211	
200 (65+80+60)	199,8/203,8	131	1208+1210+1205+1211		1287+1290+1283+1211	
205 (80+80+50)	204,8/208,8	146	1210X2+1204+1211		1290X2+1282+1211	
210 (80+75+60)	209,8/213,8	141	1220+1210+1205+1211		1289+1290+1283+1211	
215 (80+80+60)	214,8/218,8	146	1210X2+1205+1211		1290X2+1283+1211	

*Permette combinazione con laterale fisso STD nel lato della porta usando art.1222, estensibilità minima +0,7 +1,8 / espansione 2,5 cm (vedi pag. 202)

*Permette combinazione con laterale fisso STD nel lato del fisso, estensibilità minima +0,7 +0,7 / espansione 1,5 cm (vedi pag. 202)

Descrizione	Art.
Profilo espansione lato fisso +3 cm	0218
Profilo espansione lato fisso +6 cm	0029
Profilo porta (riduce fino 1 cm l'estensione), vedi pag. 285	1215
Magnete espansione +1,2 cm, vedi pag. 285	1221
Profilo espansione porte +2,5 cm, vedi pag. 285	1222
Opzione apertura IN-OUT 180°	1213

OPEN COMBI K 2 porte angolari

● Nero
Art. pag. 223





COMBI K

Cm (P+P)	Estensibilità	Apert.
40x40	40,4-41,9 / 40,4-41,9	66
40x45	40,4-41,9 / 45,4-46,9	71
45x45	45,4-46,9 / 45,4-46,9	76
45x50	45,4-46,9 / 50,4-51,9	81
45x55	45,4-46,9 / 55,4-56,9	86
45x60	45,4-46,9 / 60,4-61,9	91
45x65	45,4-46,9 / 65,4-66,9	96
45x70	45,4-46,9 / 70,4-71,9	101
45x75	45,4-46,9 / 75,4-76,9	106
45x80	45,4-46,9 / 80,4-81,9	111
50x50	50,4-51,9 / 50,4-51,9	86
50x55	50,4-51,9 / 55,4-56,9	91
50x60	50,4-51,9 / 60,4-61,9	96
50x65	50,4-51,9 / 65,4-66,9	101
50x70	50,4-51,9 / 70,4-71,9	106
50x75	50,4-51,9 / 75,4-76,9	111
50x80	50,4-51,9 / 80,4-81,9	116
55x55	55,4-56,9 / 55,4-56,9	96
55x60	55,4-56,9 / 60,4-61,9	101
55x65	55,4-56,9 / 65,4-66,9	106
55x70	55,4-56,9 / 70,4-71,9	111
55x75	55,4-56,9 / 75,4-76,9	116
55x80	55,4-56,9 / 80,4-81,9	121
60x60	60,4-61,9 / 60,4-61,9	106
60x65	60,4-61,9 / 65,4-66,9	111
60x70	60,4-61,9 / 70,4-71,9	116
60x75	60,4-61,9 / 75,4-76,9	121
60x80	60,4-61,9 / 80,4-81,9	126
65x65	65,4-66,9 / 65,4-66,9	116
65x70	65,4-66,9 / 70,4-71,9	121
65x75	65,4-66,9 / 75,4-76,9	126
65x80	65,4-66,9 / 80,4-81,9	131
70x70	70,4-71,9 / 70,4-71,9	126
70x75	70,4-71,9 / 75,4-76,9	131
70x80	70,4-71,9 / 80,4-81,9	136
75x75	75,4-76,9 / 75,4-76,9	136
75x80	75,4-76,9 / 80,4-81,9	141
80x80	80,4-81,9 / 80,4-81,9	146
80x85	80,4-81,9 / 85,4-86,9	151
85x85	85,4-86,9 / 85,4-86,9	156

TRASPARENTI	
Articolo	
1211x2 +1206	
1211x2 +1216+1217	
1211x2+1217x2	
1211x2+1217+1207	
1211x2+1217+1218	
1211x2+1217+1219	
1211x2+1217+1208	
1211x2+1217+1209	
1211x2+1217+1220	
1211x2+1217+1210	
1211x2 + 1207x2	
1211x2+1207+1218	
1211x2+1207+1219	
1211x2+1207+1208	
1211x2+1207+1209	
1211x2+1207+1220	
1211x2+1207+1210	
1211x2+1218x2	
1211x2+1218+1219	
1211x2+1218+1208	
1211x2+1218+1209	
1211x2+1218+1220	
1211x2+1218+1210	
1211x2+1219x2	
1211x2+1219+1208	
1211x2+1219+1209	
1211x2+1219+1220	
1211x2+1219+1210	
1211x2+1208x2	
1211x2+1208+1209	
1211x2+1208+1220	
1211x2+1208+1210	
1211x2+1209x2	
1211x2+1209+1220	
1211x2+1209+1210	
1211x2+1220x2	
1211x2+1220+1210	
1211x2+1210x2	
1210+1223+1211x2	
1223x2+1211x2	

FROST PLUS	
Articolo	
-	
-	
-	
-	
-	
-	
-	
-	
-	
1211x2 + 1284x2	
1211x2+1284+1285	
1211x2+1284+1286	
1211x2+1284+1287	
1211x2+1284+1288	
1211x2+1284+1289	
1211x2+1284+1290	
1211x2+1285x2	
1211x2+1285+1286	
1211x2+1285+1287	
1211x2+1285+1288	
1211x2+1285+1289	
1211x2+1285+1290	
1211x2+1286x2	
1211x2+1286+1287	
1211x2+1286+1288	
1211x2+1286+1289	
1211x2+1286+1290	
1211x2+1287x2	
1211x2+1287+1288	
1211x2+1287+1289	
1211x2+1287+1290	
1211x2+1288x2	
1211x2+1288+1289	
1211x2+1288+1290	
1211x2+1289x2	
1211x2+1289+1290	
1211x2+1290x2	
1290+1291+1211x2	
1291x2+1211x2	

Profilo espansione lato porta +2,5 cm, vedi pag. 285

1222

Profilo porta (riduce fino 1 cm l'estensione), vedi pag. 285

1215

OPEN/GLASS

Laterale fisso STD trasparente

A pannello fisso

A chiusura profilo magnetico

A porta battente

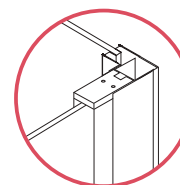
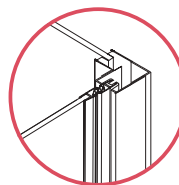
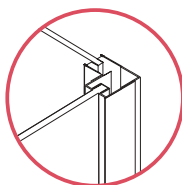

Combi E 30+70 + lat. fisso STD 70
Art. 1202+1209+1211+0814+1214



Se l'unione è nel lato fisso o nel profilo a chiusura magnetica art. 1212, si sommerà +0,7 cm all'estensione minima della combinazione + espansione del lato libero del laterale fisso. L'espansione nel lato in cui va il laterale fisso si perde.

Se l'unione è nel lato della porta si deve utilizzare art. 1222, si sommeranno +1,8 cm all'estensione minima della combinazione + espansione nel lato libero del laterale fisso.

Disponibile per combinazioni

COMBI A Lato profilo porta		COMBI B Entrambi i lati	
COMBI C Lato fisso		COMBI D Entrambi i lati	
COMBI E Entrambi i lati		COMBI F Entrambi i lati	
COMBI G Entrambi i lati		COMBI I Entrambi i lati	
COMBI J Entrambi i lati			

laterali fissi STD TRASPARENTI 8 mm

Descrizione	Esten.	Articolo	
Lat. fisso STD 30x195 + braccetto	26-29	0810+1214	
Lat. fisso STD 40x195 + braccetto	36-39	0811+1214	
Lat. fisso STD 50x195 + braccetto	46-49	0812+1214	
Lat. fisso STD 60x195 + braccetto	56-59	0813+1214	
Lat. fisso STD 70x195 + braccetto	66-69	0814+1214	
Lat. fisso STD 75x195 + braccetto	71-74	0820+1214	
Lat. fisso STD 80x195 + braccetto	76-79	0815+1214	
Lat. fisso STD 90x195 + braccetto	86-89	0816+1214	



Opzione barra parallela 140 cm art. 1716+1718+5568 (si esclude braccetto 1214)
Opzione barra parallela 200 cm art. 1717+1718+5568 (si esclude braccetto 1214)

Descrizione	Art.	
Profilo espansione +2 cm	0218	
Profilo espansione +4 cm	0029	
Profilo espansione +5,5 cm	0219	

GLASS, sostituire il braccio 1214 con il braccio 1715, p 51



Laterali fissi su misura STD TRASPARENTE 8 mm (maggiori informazioni a pagina 282)

Descrizione	Articoli	
Laterale fisso su misura STD fino 40 cm + braccetto	1343+1214	
Laterale fisso su misura STD da 40 fino 80 cm + braccetto	1304+1214	
Laterale fisso su misura STD da 80 fino 120 cm + braccetto	1310+1214	

*Tempo di consegna 3 settimane

OPEN

Laterale fisso STD Frost Plus

A pannello fisso

A chiusura profilo magnetico

A porta battente

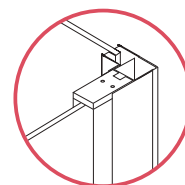
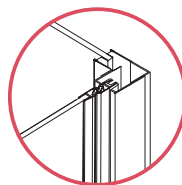
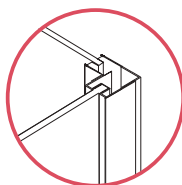

Combi C Frost 30+70 + lat. fisso Frost STD 70 + barra parallela
Art. 1280+1288+1211+0817+1716+1718+5568



Se l'unione è nel lato fisso o nel profilo a chiusura magnetica art. 1212, si sommerà +0,7 cm all'estensione minima della combinazione + espansione del lato libero del laterale fisso. L'espansione nel lato in cui va il laterale fisso si perde.

Se l'unione è nel lato della porta si deve utilizzare art. 1222, si sommeranno +1,8 cm all'estensione minima della combinazione + espansione nel lato libero del laterale fisso.

Disponibile per combinazioni

COMBI A Lato profilo porta		COMBI B Entrambi i lati	
COMBI C Lato fisso		COMBI D Entrambi i lati	
COMBI G Entrambi i lati		COMBI I Entrambi i lati	
COMBI J Entrambi i lati			

laterali fissi STD FROST PLUS 8 mm

Descrizione	Esten.	Articolo
Lat. fisso STD 70x195 + braccetto	66-69	0817+1214
Lat. fisso STD 80x195 + braccetto	76-79	0818+1214
Lat. fisso STD 90x195 + braccetto	86-89	0819+1214

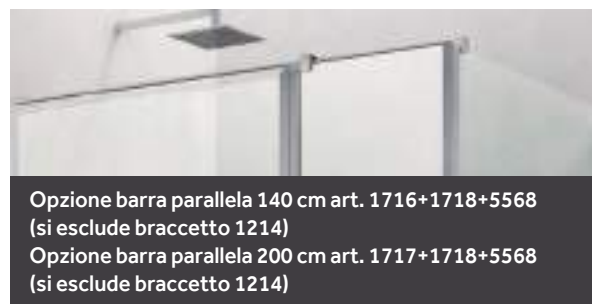

Descrizione	Articolo
Profilo espansione +2 cm	0218
Profilo espansione +4 cm	0029
Profilo espansione +5,5 cm	0219



Laterali fissi su misura STD FROST PLUS 8 mm (maggiori informazioni a pagina 282)

Descrizione	Articolo
Laterale fisso su misura STD fino 40 cm + braccetto	1343+1312+1214
Laterale fisso su misura STD da 40 fino 80 cm + braccetto	1304+1313+1214
Laterale fisso su misura STD da 80 fino 120 cm + braccetto	1310+1315+1214

*Tempo di consegna 3 settimane

OPEN BLACK COMBI A porta con chiusura magnetica a parete



COMBI A Frontale da 1 porta con chiusura magnetica a parete

Descrizione	Cm	Estensibilità	Apertura	Articoli
Frontale doccia OPEN 50 con chiusura magnetica a parete	50	51,1-52,6	43	9004 + 9012
Frontale doccia OPEN 55 con chiusura magnetica a parete	55	56,1-57,6	48	9005 + 9012
Frontale doccia OPEN 60 con chiusura magnetica a parete	60	61,1-62,6	53	9006 + 9012
Frontale doccia OPEN 65 con chiusura magnetica a parete	65	66,1-67,6	58	9007 + 9012
Frontale doccia OPEN 70 con chiusura magnetica a parete	70	71,1-72,6	63	9008 + 9012
Frontale doccia OPEN 75 con chiusura magnetica a parete	75	76,1-77,6	68	9009 + 9012
Frontale doccia OPEN 80 con chiusura magnetica a parete	80	81,1-82,6	73	9010 + 9012
Frontale doccia OPEN 85 con chiusura magnetica a parete	85	86,1-87,6	78	9011 + 9012

Descrizione	Articolo
Profilo espansione porte (+1,5 a +3 cm)	9015
Profilo porta (riduce fino 1 cm l'estensione)	9014
Magnete espansione +1,2 cm	1221
Opzione apertura IN-OUT 180°	1213



Opzione barra 140 cm + supporto laterale fisso-Art. 9026+9028
Aumenta 38 p (si esclude braccetto 9017)

Apertura esterna
90° p/fisso



Opzione in-out
180° p/fisso



L'estensibilità del frontale con
apertura in-out aumenterà di 1,4 cm
e l'estensibilità del laterale fisso si
riduce di 1 cm.

Art. 0038

COMBI A + LATERALE FISSO 70 C/BRACCETTO 9017

Cm	Estensibilità	Articoli
50X70	50,6-52,1/66-69	9004+9012+9018+9017
55X70	55,6-57,1/66-69	9005+9012+9018+9017
60X70	60,6-62,1/66-69	9006+9012+9018+9017
65X70	65,6-67,1/66-69	9007+9012+9018+9017
70X70	70,6-72,1/66-69	9008+9012+9018+9017
75X70	75,6-77,1/66-69	9009+9012+9018+9017
80X70	80,6-82,1/66-69	9010+9012+9018+9017
85X70	85,6-87,1/66-69	9011+9012+9018+9017

COMBI A + LATERALE FISSO 80 C/BRACCETTO 9017

Cm	Estensibilità	Articoli
50X80	50,6-52,1/76-79	9004+9012+9019+9017
55X80	55,6-57,1/76-79	9005+9012+9019+9017
60X80	60,6-62,1/76-79	9006+9012+9019+9017
65X80	65,6-67,1/76-79	9007+9012+9019+9017
70X80	70,6-72,1/76-79	9008+9012+9019+9017
75X80	75,6-77,1/76-79	9009+9012+9019+9017
80X80	80,6-82,1/76-79	9010+9012+9019+9017
85X80	85,6-87,1/76-79	9011+9012+9019+9017

COMBI A + LATERALE FISSO 90 C/BRACCETTO 9017

Cm	Estensibilità	Articoli
50X90	50,6-52,1/86-89	9004+9012+9020+9017
55X90	55,6-57,1/86-89	9005+9012+9020+9017
60X90	60,6-62,1/86-89	9006+9012+9020+9017
65X90	65,6-67,1/86-89	9007+9012+9020+9017
70X90	70,6-72,1/86-89	9008+9012+9020+9017
75X90	75,6-77,1/86-89	9009+9012+9020+9017
80X90	80,6-82,1/86-89	9010+9012+9020+9017
85X90	85,6-87,1/86-89	9011+9012+9020+9017

Le aperture sono le stesse dei frontali.

Laterali fissi TRASPARENTI 6 mm

Descrizione	Estensibilità	Art.
Laterale fisso 70x195	66-69	9018
Laterale fisso 80x195	76-79	9019
Laterale fisso 90x195	86-89	9020
Braccetto Open		9017

Descrizione	Art.
Profilo espansione per laterale fisso +3 cm	9016



Laterali fissi su misura 6 mm (maggiori informazioni a pagina 282)

Descrizione	Art.
Laterale fisso su misura OPEN BLACK fino 40 cm	1345N
Laterale fisso su misura OPEN BLACK da 40 fino 80 cm	1316N
Laterale fisso su misura OPEN BLACK da 80 fino 120 cm	1317N

*Tempo di consegna 3 settimane.

OPEN BLACK COMBI B porta con profilo a chiusura magnetica





COMBI B frontale da 1 porta prof. a chiusura magnetica

Descrizione	Cm	Estensibilità	Apertura	Articolo
OPEN 55 prof. a chiusura magnetica	55	53,6-57,6	43	9004 + 9012 + 9013
OPEN 60 prof. a chiusura magnetica	60	58,6-62,6	48	9005 + 9012 + 9013
OPEN 65 prof. a chiusura magnetica	65	63,6-67,6	53	9006 + 9012 + 9013
OPEN 70 prof. a chiusura magnetica	70	68,6-72,6	58	9007 + 9012 + 9013
OPEN 75 prof. a chiusura magnetica	75	73,6-77,6	63	9008 + 9012 + 9013
OPEN 80 prof. a chiusura magnetica	80	78,6-82,6	68	9009 + 9012 + 9013
OPEN 85 prof. a chiusura magnetica	85	83,6-87,6	73	9010 + 9012 + 9013
OPEN 90 prof. a chiusura magnetica	90	88,6-92,6	78	9011 + 9012 + 9013

*Opzione con laterale fisso, consultare fabbrica.

Descrizione	Art.
Profilo espansione lato profilo a chiusura magnetica +3 cm	9016
Profilo porta (riduce fino 1 cm l'estensione)	9014
Magnete espansione +1,2 cm	1221
Profilo espansione laterale porta +2,5 cm	9015
Opzione apertura IN-OUT 180°	1213

OPEN BLACK COMBI C fisso + porta a battente chiusura magnetica a parete



COMBI C

FISSI	Estensibilità cm	Art.	
FISSO 30	27,5/30	9000	
FISSO 40	37,5/40	9001	
FISSO 50	47,5/50	9002	
FISSO 60	57,5/60	9003	

(2,5 regolazione)



Pannelli fissi su misura (vedi pag. 281)

PORTE	Estensibilità cm	Art.	
PORTA 50	50	9004	
PORTA 55	55	9005	
PORTA 60	60	9006	
PORTA 65	65	9007	
PORTA 70	70	9008	
PORTA 75	75	9009	
PORTA 80	80	9010	
PORTA 85	85	9011	

(non regolabile)



COMBI C

Abbinamenti con porte 50, 55, 65, 70, 80 e 85

Cm	Fisso	Porta	Estensibilità	Apertura	Articoli
80	30	50	77,5-80	43	9000+9004
85	30	55	82,5-85	48	9000+9005
90	40	50	87,5-90	43	9001+9004
95	30	65	92,5-95	58	9000+9007
100	30	70	97,5-100	63	9000+9008
100	50	50	97,5-100	43	9002+9004
105	40	65	102,5-105	58	9001+9007
110	30	80	107,5-110	73	9000+9010
110	40	70	107,5-110	63	9001+9008
110	60	50	107,5-110	43	9003+9004
115	50	65	112,5-115	58	9002+9007
120	40	80	117,5-120	73	9001+9010
120	50	70	117,5-120	63	9002+9008
125	60	65	122,5-125	58	9003+9007
130	50	80	127,5-130	73	9002+9010
130	60	70	127,5-130	63	9003+9008
135	60	75	132,5-135	68	9003+9009
140	60	80	137,5-140	73	9003+9010
145	60	85	142,5-145	78	9003+9011

*Permette combinazione con laterale fisso Glass nel lato della porta, l'estensione del frontale si riduce di 0,5 cm.

Descrizione	Art.
Profilo espansione lato profilo a chiusura magnetica +3 cm	9016
Profilo porta (riduce fino 1 cm l'estensione)	9014
Magnete espansione +1,2 cm	1221
Profilo espansione laterale porta +2,5 cm	9015
Opzione apertura IN-OUT 180°	1213

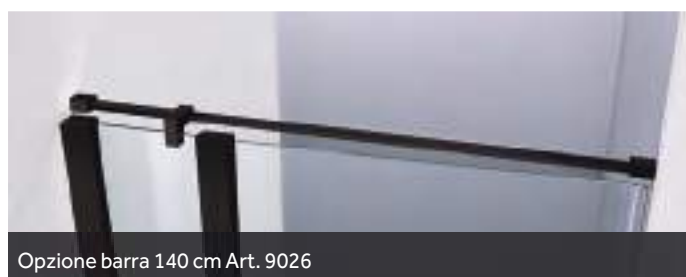

Opzione barra 140 cm Art. 9026



*Opzione installazione formato Free, est. -3 cm

OPEN BLACK COMBI C + laterale fisso



Laterali fissi TRASPARENTI 6 mm

Descrizione	Estensibilità	Articolo	
Laterale fisso 70x195	66-69	9018	
Laterale fisso 80x195	76-79	9019	
Laterale fisso 90x195	86-89	9020	
Braccetto Open		9017	

Descrizione	Articoli	
Profilo espansione +3 cm lato fisso	9016	



Laterali fissi su misura 6 mm (maggiori informazioni a pagina 282)

Descrizione	Art.		
Laterale fisso su misura OPEN BLACK fino 40 cm	1345N		
Laterale fisso su misura OPEN BLACK da 40 fino 80 cm	1316N		
Laterale fisso su misura OPEN BLACK da 80 fino 120 cm	1317N		

*Tempo di consegna 3 settimane.



COMBI C + LATERALE FISSO 70 C/BRACCETTO 9017

Cm (F+A) xLF	Estensibilità	Articoli
80 (30+50) x70	77-79,5/66-69	9000+9004+9018+9017
85 (30+55) x70	82-84,5/66-69	9000+9005+9018+9017
90 (40+50) x70	87-89,5/66-69	9001+9004+9018+9017
95 (30+65) x70	92-94,5/66-69	9000+9007+9018+9017
100 (30+70) x70	97-99,5/66-69	9000+9008+9018+9017
100 (50+50) x70	97-99,5/66-69	9002+9004+9018+9017
105 (40+65) x70	102-104,5/66-69	9001+9007+9018+9017
110 (30+80) x70	107-109,5/66-69	9000+9010+9018+9017
110 (40+70) x70	107-109,5/66-69	9001+9008+9018+9017
110 (60+50) x70	107-109,5/66-69	9003+9004+9018+9017
115 (50+65) x70	112-114,5/66-69	9002+9007+9018+9017
120 (40+80) x70	117-119,5/66-69	9001+9010+9018+9017
120 (50+70) x70	117-119,5/66-69	9002+9008+9018+9017
125 (60+65) x70	122-124,5/66-69	9003+9007+9018+9017
130 (50+80) x70	127-129,5/66-69	9002+9010+9018+9017
130 (60+70) x70	127-129,5/66-69	9003+9008+9018+9017
135 (60+75) x70	132-134,5/66-69	9003+9009+9018+9017
140 (60+80) x70	137-139,5/66-69	9003+9010+9018+9017
145 (60+85) x70	142-144,5/66-69	9003+9011+9018+9017

Apertura esterna
90° p/fisso



Opzione in-out
180° p/fisso



L'estensibilità del frontale con
apertura in-out aumenterà di 1,4 cm
e l'estensibilità del laterale fisso si
riduce di 1 cm.
Art. 0038



Opzione barra 140 cm + supporto laterale - Art. 9026+9028
(si esclude braccetto 9017)

COMBI C + LATERALE FISSO 80 C/BRACCETTO 9017

Cm (F+A) xLF	Estensibilità	Articoli
80 (30+50) x80	77-79,5/76-79	9000+9004+9019+9017
85 (30+55) x80	82-84,5/76-79	9000+9005+9019+9017
90 (40+50) x80	87-89,5/76-79	9001+9004+9019+9017
95 (30+65) x80	92-94,5/76-79	9000+9007+9019+9017
100 (30+70) x80	97-99,5/76-79	9000+9008+9019+9017
100 (50+50) x80	97-99,5/76-79	9002+9004+9019+9017
105 (40+65) x80	102-104,5/76-79	9001+9007+9019+9017
110 (30+80) x80	107-109,5/76-79	9000+9010+9019+9017
110 (40+70) x80	107-109,5/76-79	9001+9008+9019+9017
110 (60+50) x80	107-109,5/76-79	9003+9004+9019+9017
115 (50+65) x80	112-114,5/76-79	9002+9007+9019+9017
120 (40+80) x80	117-119,5/76-79	9001+9010+9019+9017
120 (50+70) x80	117-119,5/76-79	9002+9008+9019+9017
125 (60+65) x80	122-124,5/76-79	9003+9007+9019+9017
130 (50+80) x80	127-129,5/76-79	9002+9010+9019+9017
130 (60+70) x80	127-129,5/76-79	9003+9008+9019+9017
135 (60+75) x80	132-134,5/76-79	9003+9009+9019+9017
140 (60+80) x80	137-139,5/76-79	9003+9010+9019+9017
145 (60+85) x80	142-144,5/76-79	9003+9011+9019+9017

COMBI C + LATERALE FISSO 90 C/BRACCETTO 9017

Cm (F+A) xLF	Estensibilità	Articoli
80 (30+50) x90	77-79,5/86-89	9000+9004+9020+9017
85 (30+55) x90	82-84,5/86-89	9000+9005+9020+9017
90 (40+50) x90	87-89,5/86-89	9001+9004+9020+9017
95 (30+65) x90	92-94,5/86-89	9000+9007+9020+9017
100 (30+70) x90	97-99,5/86-89	9000+9008+9020+9017
100 (50+50) x90	97-99,5/86-89	9002+9004+9020+9017
105 (40+65) x90	102-104,5/86-89	9001+9007+9020+9017
110 (30+80) x90	107-109,5/86-89	9000+9010+9020+9017
110 (40+70) x90	107-109,5/86-89	9001+9008+9020+9017
110 (60+50) x90	107-109,5/86-89	9003+9004+9020+9017
115 (50+65) x90	112-114,5/86-89	9002+9007+9020+9017
120 (40+80) x90	117-119,5/86-89	9001+9010+9020+9017
120 (50+70) x90	117-119,5/86-89	9002+9008+9020+9017
125 (60+65) x90	122-124,5/86-89	9003+9007+9020+9017
130 (50+80) x90	127-129,5/86-89	9002+9010+9020+9017
130 (60+70) x90	127-129,5/86-89	9003+9008+9020+9017
135 (60+75) x90	132-134,5/86-89	9003+9009+9020+9017
140 (60+80) x90	137-139,5/86-89	9003+9010+9020+9017
145 (60+85) x90	142-144,5/86-89	9003+9011+9020+9017

OPEN BLACK COMBI D fisso + porta a battente profilo a chiusura magnetica



COMBI D

FISSI	Estensibilità cm	Art.	
FISSO 30	27,5/30	9000	
FISSO 40	37,5/40	9001	
FISSO 50	47,5/50	9002	
FISSO 60	57,5/60	9003	
(2,5 regolazione)			
Profilo a chiusura magnetica art. 9013			



Pannelli fissi su misura (vedi pag. 281)

PORTE	Estensibilità cm	Art.	
PORTA 50	50	9004+9013	
PORTA 55	55	9005+9013	
PORTA 60	60	9006+9013	
PORTA 65	65	9007+9013	
PORTA 70	70	9008+9013	
PORTA 75	75	9009+9013	
PORTA 80	80	9010+9013	
PORTA 85	85	9011+9013	

(2,5 regolazione)



COMBI D

Abbinamenti con porte 50, 55, 65, 70, 80 e 85

Cm	Estensibilità	Fisso	Porta	Apertura	Articoli
80	80-85	30	50	43	9000+9004+9013
85	85-90	30	55	48	9000+9005+9013
90	90-95	40	50	43	9001+9004+9013
95	95-100	30	65	58	9000+9007+9013
100	100-105	30	70	63	9000+9008+9013
100	100-105	50	50	43	9002+9004+9013
105	105-110	40	65	58	9001+9007+9013
110	110-115	30	80	73	9000+9010+9013
110	110-115	40	70	63	9001+9008+9013
110	110-115	60	50	43	9003+9004+9013
115	115-120	50	65	58	9002+9007+9013
120	120-125	40	80	73	9001+9010+9013
120	120-125	50	70	63	9002+9008+9013
125	125-130	60	65	58	9003+9007+9013
130	130-135	50	80	73	9002+9010+9013
130	130-135	60	70	63	9003+9008+9013
135	135-140	60	75	68	9003+9009+9013
140	140-145	60	80	73	9003+9010+9013
145	145-150	60	85	78	9003+9011+9013

*Permette uso profilo di compensazione in entrambi i lati

*Opzione con laterale fisso, consultare fabbrica.

Descrizione	Articolo
Profilo espansione lato fisso +3 cm	9016
Magnete espansione +1,2 cm	1221
Opzione apertura IN-OUT 180°	1213

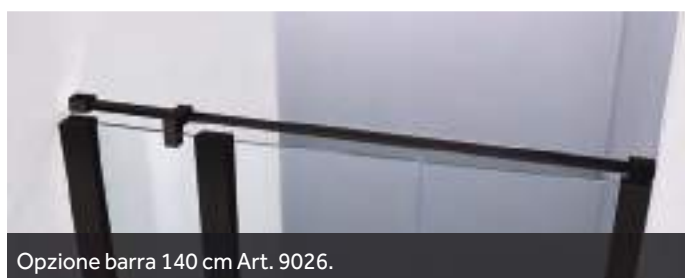

Opzione barra 140 cm Art. 9026.

OPEN BLACK COMBI E fisso + porta a battente con chiusura a fisso



Opzione barra 140 cm + supporto - Art. 9026

COMBI E

FISSI	Estensibilità cm	Art.	
FISSO 30	27,5/30	9000	
FISSO 40	37,5/40	9001	
FISSO 50	47,5/50	9002	
FISSO 60	57,5/60	9003	
(2,5 regolazione)			
Profilo a chiusura magnetica art. 9012			



Pannelli fissi su misura (vedi pag. 281)

PORTE	Estensibilità cm	Art.	
PORTA 50	50	9004+9012	
PORTA 55	55	9005+9012	
PORTA 60	60	9006+9012	
PORTA 65	65	9007+9012	
PORTA 70	70	9008+9012	
PORTA 75	75	9009+9012	
PORTA 80	80	9010+9012	
PORTA 85	85	9011+9012	

(1,5 regolazione)



COMBI E

Abbinamenti con porte 50, 55, 65, 70, 80 e 85

Cm	Estensibilità	Fisso	Porta	Apertura	Articoli
80	78,6-82,6	30	50	43	9000+9004+9012
85	83,6-87,6	30	55	48	9000+9005+9012
90	88,6-92,6	40	50	43	9001+9004+9012
95	93,6-97,6	30	65	58	9000+9007+9012
100	98,6-102,6	30	70	63	9000+9008+9012
100	98,6-102,6	50	50	43	9002+9004+9012
105	103,6-107,6	40	65	58	9001+9007+9012
110	108,6-112,6	30	80	73	9000+9010+9012
110	108,6-112,6	40	70	63	9001+9008+9012
110	108,6-112,6	60	50	43	9003+9004+9012
115	113,6-117,6	50	65	58	9002+9007+9012
120	118,6-122,6	40	80	73	9001+9010+9012
120	118,6-122,6	50	70	63	9002+9008+9012
125	123,6-127,6	60	65	58	9003+9007+9012
130	128,6-132,6	50	80	73	9002+9010+9012
130	128,6-132,6	60	70	63	9003+9008+9012
135	133,6-137,6	60	75	68	9003+9009+9012
140	138,6-142,6	60	80	73	9003+9010+9012
145	143,6-147,6	60	85	78	9003+9011+9012

*Opzione con laterale fisso, consultare fabbrica.

Descrizione	Art.
Profilo espansione lato fisso +3 cm	9016
Profilo porta (riduce fino 1 cm l'estensione)	9014
Magnete espansione +1,2 cm	1221
Profilo espansione porte +2,5 cm	9015
Opzione apertura IN-OUT 180°	1213

OPEN BLACK COMBI F 2 fissi + porta a battente con chiusura a fisso



COMBI F

FISSI	Estensibilità cm	Art.	
FISSO 30	27,5/30	9000	
FISSO 40	37,5/40	9001	
FISSO 50	47,5/50	9002	
FISSO 60	57,5/60	9003	

regolazione 2,5x2 = 5 cm



Pannelli fissi su misura (vedi pag. 281)

PORTE	Estensibilità cm	Art.	
PORTA 50	50	9004	
PORTA 55	55	9005	
PORTA 60	60	9006	
PORTA 65	65	9007	
PORTA 70	70	9008	
PORTA 75	75	9009	
PORTA 80	80	9010	
PORTA 85	85	9011	



COMBI F

Abbinamenti con porte 50, 55, 65, 70, 80 e 85

Cm (F+P+F)	Estensibilità	Ap.	Articoli
110 (30+50+30)	105-110	43	9000+9004+9000
115 (30+55+30)	110-115	48	9000+9005+9000
120 (30+50+40)	115-120	43	9000+9004+9001
125 (30+65+30)	120-125	58	9000+9007+9000
130 (30+70+30)	125-130	63	9000+9008+9000
135 (30+65+40)	130-135	58	9000+9007+9001
140 (30+70+40)	135-140	63	9000+9008+9001
140 (30+80+30)	135-140	73	9000+9010+9000
140 (30+50+60)	135-140	43	9000+9004+9003
145 (30+65+50)	140-145	58	9000+9007+9002
145 (40+65+40)	140-145	58	9001+9007+9001
150 (40+50+60)	145-150	43	9001+9004+9003
150 (30+70+50)	145-150	63	9000+9008+9002
150 (40+70+40)	145-150	63	9001+9008+9001
150 (30+80+40)	145-150	73	9000+9010+9001
155 (30+65+60)	150-155	58	9000+9007+9003
155 (40+65+50)	150-155	58	9001+9007+9002
160 (50+50+60)	155-160	43	9002+9004+9003
160 (30+70+60)	155-160	63	9000+9008+9003

Cm (F+P+F)	Estensibilità	Ap.	Articoli
160 (40+70+50)	155-160	63	9001+9008+9002
160 (30+80+50)	155-160	73	9000+9010+9002
160 (40+80+40)	155-160	73	9001+9010+9001
165 (40+65+60)	160-165	58	9001+9007+9003
165 (50+65+50)	160-165	58	9002+9007+9002
170 (60+50+60)	165-170	43	9003+9004+9003
170 (40+70+60)	165-170	63	9001+9008+9003
170 (50+70+50)	165-170	63	9002+9008+9002
170 (30+80+60)	165-170	73	9000+9010+9003
170 (40+80+50)	165-170	73	9001+9010+9002
175 (50+65+60)	170-175	58	9002+9007+9003
180 (50+70+60)	175-180	63	9002+9008+9003
180 (40+80+60)	175-180	73	9001+9010+9003
180 (50+80+50)	175-180	73	9002+9010+9002
185 (60+65+60)	180-185	58	9003+9007+9003
190 (60+70+60)	185-190	63	9003+9008+9003
190 (50+80+60)	185-190	73	9002+9010+9003
195 (60+75+60)	190-195	68	9003+9009+9003
200 (60+80+60)	195-200	73	9003+9010+9003

*Opzione con laterale fisso, consultare fabbrica.

Descrizione	Art.
Profilo espansione lato fisso +3 cm	9016
Magnete espansione +1,2 cm	1221
Opzione apertura IN-OUT 180°	1213

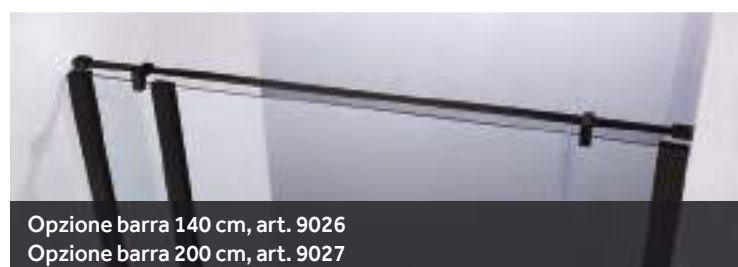

Opzione barra 140 cm, art. 9026
Opzione barra 200 cm, art. 9027



OPEN BLACK COMBI G fisso + 2 porte a battente + fisso



Opzione barra 200 + supporti Art. 9027. Aumenta di 120 p

COMBI G

FISSI	Estensibilità cm	Art.	
FISSO 30	27,5/30	9000	
FISSO 40	37,5/40	9001	
FISSO 50	47,5/50	9002	
FISSO 60	57,5/60	9003	

regolazione 2,5x2 = 5 cm



Pannelli fissi su misura (vedi pag. 281)

PORTE	Estensibilità cm	Art.	
PORTA 50	50	9004	
PORTA 55	55	9005	
PORTA 60	60	9006	
PORTA 65	65	9007	
PORTA 70	70	9008	
PORTA 75	75	9009	
PORTA 80	80	9010	
PORTA 85	85	9011	



COMBI G

Abbinamenti con porte 50, 65, 70 e 80

Cm (F+P+P+F)	Estensibilità	Articoli
155 (30+50+50+30)	151,2-156,2	9000x2+9004x2
165 (30+50+50+40)	161,2-166,2	9000+9001+9004x2
175 (30+50+50+50)	171,2-176,2	9000+9002+9004x2
175 (40+50+50+40)	171,2-176,2	9001x2+9004x2
185 (40+50+50+50)	181,2-186,2	9001+9002+9004x2
185 (30+50+50+60)	181,2-186,2	9000+9003+9004x2
185 (30+65+65+30)	181,2-186,2	9000x2+9007x2
195 (50+50+50+50)	191,2-196,2	9002x2+9004x2
195 (40+50+50+60)	191,2-196,2	9001+9003+9004x2
195 (30+65+65+40)	191,2-196,2	9000+9001+9007x2
195 (30+70+70+30)	191,2-196,2	9000x2+9008x2
205 (40+65+65+40)	201,2-206,2	9001x2+9007x2
205(30+65+65+50)	201,2-206,2	9000+9002+9007x2
205 (30+70+70+40)	201,2-206,2	9000+9001+9008x2
205 (50+50+50+60)	201,2-206,2	9002+9003+9004x2
215 (30+65+65+60)	211,2-216,2	9000+9003+9007x2
215 (40+65+65+50)	211,2-216,2	9001+9002+9007x2
215 (30+70+70+50)	211,2-216,2	9000+9002+9008x2
215 (40+70+70+40)	211,2-216,2	9001x2+9008x2
215 (30+80+80+30)	211,2-216,2	9000x2+9010x2

*Opzione con laterale fisso, consultare fabbrica.

COMBI G

Abbinamenti con porte 50, 65, 70 e 80

Cm (F+P+P+F)	Estensibilità	Articoli
215 (60+50+50+60)	211,2-216,2	9003x2+9004x2
225 (50+65+65+50)	221,2-226,2	9002x2+9007x2
225 (40+65+65+60)	221,2-226,2	9001+9003+9007x2
225 (30+70+70+60)	221,2-226,2	9000+9003+9008x2
225 (40+70+70+50)	221,2-226,2	9001+9002+9008x2
225 (30+80+80+40)	221,2-226,2	9000+9001+9010x2
235 (50+65+65+60)	231,2-236,2	9002+9003+9007x2
235 (40+70+70+60)	231,2-236,2	9001+9003+9008x2
235 (50+70+70+50)	231,2-236,2	9002x2+9008x2
235 (40+80+80+40)	231,2-236,2	9001x2+9010x2
245 (60+65+65+60)	241,2-246,2	9003x2+9007x2
245 (50+70+70+60)	241,2-246,2	9002+9003+9008x2
245 (30+80+80+60)	241,2-246,2	9000+9003+9010x2
245 (40+80+80+50)	241,2-246,2	9001+9002+9010x2
255 (60+70+70+60)	251,2-256,2	9003x2+9008x2
255 (40+80+80+60)	251,2-256,2	9001+9003+9010x2
255 (50+80+80+50)	251,2-256,2	9002x2+9010x2
265 (50+80+80+60)	261,2-266,2	9002+9003+9010x2
275 (60+80+80+60)	271,2-276,2	9003x2+9010x2

Descrizione	Art.
Profilo espansione lato fisso +3 cm	9016
Magnete espansione +1,2 cm	1221

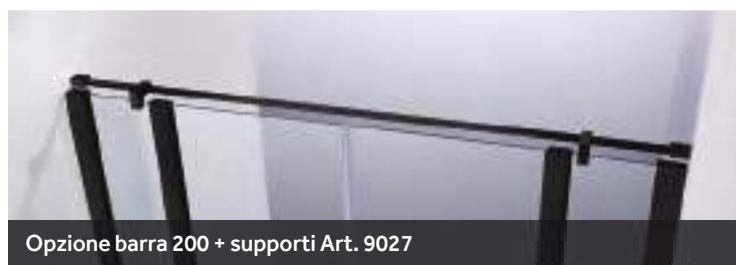

Opzione barra 200 + supporti Art. 9027

OPEN BLACK COMBI H angolare 2 porte a battente + 2 fissi



COMBI H

FISSI	Estensibilità cm	Art.	
FISSO 30	27,5/30	9000	
FISSO 40	37,5/40	9001	
FISSO 50	47,5/50	9002	
FISSO 60	57,5/60	9003	

(regolazione 2,5 cm)



Pannelli fissi su misura (vedi pag. 281)

PORTE	Estensibilità cm	Art.	
PORTA 50	50	9004	
PORTA 55	55	9005	
PORTA 60	60	9006	
PORTA 65	65	9007	
PORTA 70	70	9008	
PORTA 75	75	9009	
PORTA 80	80	9010	
PORTA 85	85	9011	



COMBI H

Abbinamenti con porte 50, 65, 70 e 80

Cm (F+P+P+F)	Estensibilità	Articoli
80X80(30+50+50+30)	77-79,5 / 77-79,5	9000x2+ 9004x2
90x90(40+50+50+40)	87-89,5 / 87-89,5	9001x2+9004x2
95x95(30+65+65+30)	92-94,5 / 92-94,5	9000x2+9007x2
100x100(30+70+70+30)	97-99,5 / 97-99,5	9000x2+9008x2
100x100(50+50+50+50)	97-99,5 / 97-99,5	9002x2+9004x2
90x80(40+50+50+30)	87-89,5 / 77-79,5	9001+9000+9004x2
95x80(30+65+50+30)	92-94,5 / 77-79,5	9000+9007+9000+9004
100x80(30+70+50+30)	97-99,5 / 77-79,5	9000+9008+9000+9004
105x80(40+65+50+30)	102-104,5 / 77-79,5	9001+9007+9000+9004
110X80(60+50+50+30)	107-109,5 / 77-79,5	9003+9004+9000+9004
110X80(40+70+50+30)	107-109,5 / 77-79,5	9001+9008+9000+9004
110X80(30+80+50+30)	107-109,5 / 77-79,5	9000x2+9010+9004
115X80(50+65+50+30)	112-114,5 / 77-79,5	9002+9007+9000+9004
120x80(50+70+50+30)	117-119,5 / 77-79,5	9002+9008+9000+9004
120x80(40+80+50+30)	117-119,5 / 77-79,5	9001+9010+9000+9004
125x80(60+65+50+30)	122-124,5 / 77-79,5	9003+9007+9000+9004
130x80(50+80+50+30)	127-129,5 / 77-79,5	9002+9010+9000+9004
130x80(60+70+50+30)	127-129,5 / 77-79,5	9003+9008+9000+9004
140x80(60+80+50+30)	137-139,5 / 77-79,5	9003+9010+9000+9004
95x90(30+65+50+40)	92-94,5 / 87-89,5	9000+9007+9001+9004
100x90(30+70+50+40)	97-99,5 / 87-89,5	9000+9008+9001+9004
105x90(40+65+50+40)	102-104,5 / 87-89,5	9001x2+9007+9004
110x90(60+50+50+40)	107-109,5 / 87-89,5	9003+9001+9004x2
110x90(40+70+50+40)	107-109,5 / 87-89,5	9001x2+9008+9004
110x90(30+80+50+40)	107-109,5 / 87-89,5	9000+9010+9001+9004
115x90(50+65+50+40)	112-114,5 / 87-89,5	9002+9007+9001+9004
120x90(50+70+50+40)	117-119,5 / 87-89,5	9002+9008+9001+9004
120x90(40+80+50+40)	117-119,5 / 87-89,5	9001x2+9010+9004
125x90(60+65+50+40)	122-124,5 / 87-89,5	9003+9007+9001+9004
130x90(60+70+50+40)	127-129,5 / 87-89,5	9003+9008+9001+9004
130x90(50+80+50+40)	127-129,5 / 87-89,5	9002+9010+9001+9004
140x90(60+80+50+40)	137-139,5 / 87-89,5	9003+9010+9001+9004

Descrizione	Art.
Profilo espansione lato fisso +3 cm	9016

OPEN BLACK COMBI | 2 porte a battente



**H195**

Altezza

**6mm**

Vetro



Opzione 180°



Magnetico

**15 cm**

Espandibile



Reversibile

aluminio
AL
aluminiumclear
shield
glass

COMBI | Abbinamenti con porte 50, 55, 65, 70, 80 e 85

Cm (P+P)	Estensibilità	Apert.	Articoli
100 (50+50)	99-102	86	9004x2+9012X2
105 (50+55)	104-107	91	9004+9005+9012X2
110 (55+55)	109-112	96	9005x2+9012x2
115 (55+60)	114-117	101	9005+9006+9012x2
120 (60+60)	119-122	106	9006+9006+9012x2
125 (60+65)	124-127	111	9006+9007+9012x2
130 (65+65)	129-132	116	9007x2+9012x2
135 (65+70)	134-137	121	9007+9008+9012x2
140 (70+70)	139-142	126	9008x2+9012x2
145 (70+75)	144-147	131	9008+9009+9012x2
150 (75+75)	149-152	136	9009x2+9012x2
155 (75+80)	154-157	141	9009+9010+9012x2
160 (80+80)	159-162	146	9010x2+9012x2
165 (80+85)	164-167	151	9010+9011+9012x2
170 (85+85)	169-172	156	9011x2+9012x2

*Opzione con laterale fisso, consultare fabbrica.

Descrizione	Art.
Magnete espansione +1,2 cm	1221
Profilo espansione porte +2,5 cm	9015
Profilo porta (riduce fino 1 cm l'estensione)	9014

OPEN BLACK COMBI J 1 fisso +2 porte a battente



COMBI J

FISSI	Estensibilità cm	Art.	
FISSO 30	27,5/30	9000	
FISSO 40	37,5/40	9001	
FISSO 50	47,5/50	9002	
FISSO 60	57,5/60	9003	
(2,5 regolazione)			
Profilo a chiusura magnetica art. 9012			



Pannelli fissi su misura (vedi pag. 281)

PORTE	Estensibilità cm	Art.	
PORTA 50	50	9004	
PORTA 55	55	9005	
PORTA 60	60	9006	
PORTA 65	65	9007	
PORTA 70	70	9008	
PORTA 75	75	9009	
PORTA 80	80	9010	
PORTA 85	85	9011	

(1,5 regolazione)



COMBI J Abbinamenti con porte 50, 55, 65, 70, 75 e 80

Cm (P+P+F)	Estensibilità	Apertura	Articoli
125 (50+50+30)	124,8/128,8	86	9004x2+9000+9012
130 (50+55+30)	129,8/133,8	91	9004+9005+9000+9012
135 (50+50+40)	134,8/138,8	86	9004x2+9001+9012
140 (60+55+30)	139,8/143,8	101	9006+9005+9000+9012
145 (50+50+50)	144,8/148,8	86	9004x2+9002+9012
150 (60+60+30)	149,8/153,8	106	9006x2+9000+9012
155 (55+55+50)	154,8/158,8	96	9005x2+9002+9012
160 (60+55+50)	159,8/163,8	101	9006+9005+9002+9012
165 (65+65+40)	164,8/168,8	116	9007x2+9001+9012
170 (75+70+30)	169,8/173,8	121	9009+9008+9000+9012
175 (75+75+30)	174,8/178,8	136	9009x2+9000+9012
180 (80+75+30)	179,8/183,8	141	9010+9009+9000+9012
185 (80+80+30)	184,8/188,8	146	9010x2+9000+9012
190 (65+70+60)	189,8/193,8	121	9007+9008+9003+9012
195 (75+75+50)	194,8/198,8	136	9009x2+9002+9012
200 (75+80+50)	199,8/203,8	131	9009+9010+9002+9012
205 (80+80+50)	204,8/208,8	146	9010x2+9002+9012
210 (80+75+60)	209,8/213,8	141	9009+9010+9003+9012
215 (80+80+60)	214,8/218,8	146	9010x2+9003+9012

*Opzione con laterale fisso, consultare fabbrica.

Descrizione	Art.
Profilo espansione lato fisso +3 cm	9016
Profilo porta (riduce fino 1 cm l'estensione)	9014
Magnete espansione +1,2 cm	1221
Profilo espansione porte +2,5 cm	9015

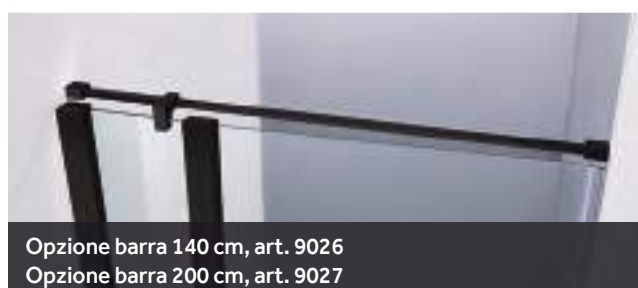

glass

"Soluzioni per ogni spazio
con l'eleganza delle porte a
battente e pieghevoli."





GLASS

GLASS

fisso + porta a battente con chiusura magnetica a parete

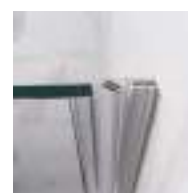

Opzione barra 140 cm Art. 1716

COMBI C

FISSI	Estensibilità	Art.
FISSO 20	17/20	1700
FISSO 25	22/25	1701
FISSO 30	27/30	1702
FISSO 40	37/40	1703
FISSO 50	47/50	1704
FISSO 60	57/60	1705

(3 cm regolazione)

PORTE	Cm	Art.
PORTA 30	30	1725
PORTA 35	35	1727
PORTA 40	40	1726
PORTA 45	45	1728
PORTA 50	50	1706
PORTA 65	65	1707
PORTA 70	70	1708
PORTA 80	80	1709

(non regolabile)



Pannelli fissi e porte su misura vedi pag. 281



COMBI C

Abbinamenti con porte 50, 65, 70 e 80

Cm	Fisso	Porta	Apertura	Estensibilità	Articoli
70	20	50	47	67-70	1700+1706
75	25	50	47	72-74	1701+1706
80	30	50	47	77-80	1702+1706
85	20	65	62	82-85	1700+1707
90	25	65	62	87-90	1701+1707
90	20	70	67	87-90	1700+1708
90	40	50	47	87-90	1703+1706
95	25	70	67	92-95	1701+1708
95	30	65	62	92-95	1702+1707
100	30	70	67	97-100	1702+1708
100	50	50	47	97-100	1704+1706
100	20	80	77	97-100	1700+1709
105	25	80	77	102-105	1701+1709
105	40	65	62	102-105	1703+1707
110	30	80	77	107-110	1702+1709
110	40	70	67	107-110	1703+1708
110	60	50	47	107-110	1705+1706
115	50	65	62	112-115	1704+1707
120	40	80	77	117-120	1703+1709
120	50	70	67	117-120	1704+1708
125	60	65	62	122-125	1705+1707
130	50	80	77	127-130	1704+1709
130	60	70	67	127-130	1705+1708
140	60	80	77	137-140	1705+1709

*Permette abbinamento con laterale fisso STD nel lato fisso, estensibilità minima +0,7 (senza regolazione), vedi pag. 202.

*Permette abbinamento con laterale fisso Glass nel lato della porta. L'estensibilità del frontale si ridurrà di 0,5 cm. Espandibile 3 cm.

Descrizione	Articoli
Profilo espansione +2 cm lato fisso	0218
Profilo espansione +4 cm lato fisso	0029
Magnete espansione +1,2 cm (vedi pag. 285)	1221

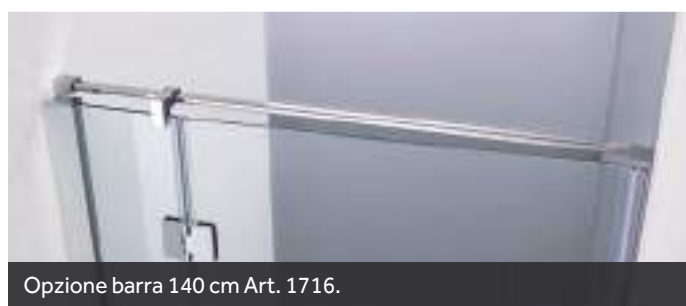

GLASS COMBI C + lat. fisso



Laterali fissi GLASS 6 mm

Descrizione	Estensibilità	Art.	
Laterale fisso 70x195	66-69	1720	
Laterale fisso 80x195	76-79	1721	
Laterale fisso 90x195	86-89	1722	
Braccetto orientabile		1715	

Descrizione	Articolo		
Profilo espansione +2 cm	0218		
Profilo espansione +4 cm	0029		
Profilo espansione +5,5 cm	0219		



Laterali fissi su misura 6 mm (maggiori informazioni a pagina 282)

Descrizione	Articolo		
Laterale fisso su misura OPEN/GLASS fino 40 cm	1345		
Laterale fisso su misura OPEN/GLASS da 40 fino 80 cm	1316		
Laterale fisso su misura OPEN/GLASS da 80 fino 120 cm	1317		

*Tempo di consegna 3 settimane

COMBI C + LATERALE FISSO 70 c/BRACCETTO 1715

Cm (F+A)xLF	Estensibilità	Articoli
70 (20+50) x70	66,5-69,5/66-69	1700+1706+1720+1715
75 (25+50) x70	71,5-74,5/66-69	1701+1706+1720+1715
80 (30+50) x70	76,5-79,5/66-69	1702+1706+1720+1715
85 (20+65) x70	81,5-84,5/66-69	1700+1707+1720+1715
90 (25+65) x70	86,5-89,5/66-69	1701+1707+1720+1715
90 (20+70) x70	86,5-89,5/66-69	1700+1708+1720+1715
90 (40+50) x70	86,5-89,5/66-69	1703+1706+1720+1715
95 (25+70) x70	91,5-94,5/66-69	1701+1708+1720+1715
95 (30+65) x70	91,5-94,5/66-69	1702+1707+1720+1715
100 (30+70) x70	96,5-99,5/66-69	1702+1708+1720+1715
100 (50+50) x70	96,5-99,5/66-69	1704+1706+1720+1715
100 (20+80) x70	96,5-99,5/66-69	1700+1709+1720+1715
105 (25+80) x70	101,5-104,5/66-69	1701+1709+1720+1715
105 (40+65) x70	101,5-104,5/66-69	1703+1707+1720+1715
110 (30+80) x70	106,5-109,5/66-69	1702+1709+1720+1715
110 (40+70) x70	106,5-109,5/66-69	1703+1708+1720+1715
110 (60+50) x70	106,5-109,5/66-69	1705+1706+1720+1715
115 (50+65) x70	111,5-114,5/66-69	1704+1707+1720+1715
120 (40+80) x70	116,5-119,5/66-69	1703+1709+1720+1715
120 (50+70) x70	116,5-119,5/66-69	1704+1708+1720+1715
125 (60+65) x70	121,5-124,5/66-69	1705+1707+1720+1715
130 (50+80) x70	126,5-129,5/66-69	1704+1709+1720+1715
130 (60+70) x70	126,5-129,5/66-69	1705+1708+1720+1715
140 (60+80) x70	136,5-139,5/66-69	1705+1709+1720+1715



Fissaggio a magneti
Apertura esterna
90° p/fisso



Opzione barra 140 cm + supporto laterale fisso-Art. 1716+1718
(si esclude braccetto 1715)

COMBI C + LATERALE FISSO 80 c/BRACCETTO 1715

Cm (F+A)xLF	Estensibilità	Articoli
70 (20+50) x80	66,5-69,5/76-79	1700+1706+1721+1715
75 (25+50) x80	71,5-74,5/76-79	1701+1706+1721+1715
80 (30+50) x80	76,5-79,5/76-79	1702+1706+1721+1715
85 (20+65) x80	81,5-84,5/76-79	1700+1707+1721+1715
90 (25+65) x80	86,5-89,5/76-79	1701+1707+1721+1715
90 (20+70) x80	86,5-89,5/76-79	1700+1708+1721+1715
90 (40+50) x80	86,5-89,5/76-79	1703+1706+1721+1715
95 (25+70) x80	91,5-94,5/76-79	1701+1708+1721+1715
95 (30+65) x80	91,5-94,5/76-79	1702+1707+1721+1715
100 (30+70) x80	96,5-99,5/76-79	1702+1708+1721+1715
100 (50+50) x80	96,5-99,5/76-79	1704+1706+1721+1715
100 (20+80) x80	96,5-99,5/76-79	1700+1709+1721+1715
105 (25+80) x80	101,5-104,5/76-79	1701+1709+1721+1715
105 (40+65) x80	101,5-104,5/76-79	1703+1707+1721+1715
110 (30+80) x80	106,5-109,5/76-79	1702+1709+1721+1715
110 (40+70) x80	106,5-109,5/76-79	1703+1708+1721+1715
110 (60+50) x80	106,5-109,5/76-79	1705+1706+1721+1715
115 (50+65) x80	111,5-114,5/76-79	1704+1707+1721+1715
120 (40+80) x80	116,5-119,5/76-79	1703+1709+1721+1715
120 (50+70) x80	116,5-119,5/76-79	1704+1708+1721+1715
125 (60+65) x80	121,5-124,5/76-79	1705+1707+1721+1715
130 (50+80) x80	126,5-129,5/76-79	1704+1709+1721+1715
130 (60+70) x80	126,5-129,5/76-79	1705+1708+1721+1715
140 (60+80) x80	136,5-139,5/76-79	1705+1709+1721+1715

COMBI C + LATERALE FISSO 90 c/BRACCETTO 1715

Cm (F+A)xLF	Estensibilità	Articoli
70 (20+50) x90	66,5-69,5/86-89	1700+1706+1722+1715
75 (25+50) x90	71,5-74,5/86-89	1701+1706+1722+1715
80 (30+50) x90	76,5-79,5/86-89	1702+1706+1722+1715
85 (20+65) x90	81,5-84,5/86-89	1700+1707+1722+1715
90 (25+65) x90	86,5-89,5/86-89	1701+1707+1722+1715
90 (20+70) x90	86,5-89,5/86-89	1700+1708+1722+1715
90 (40+50) x90	86,5-89,5/86-89	1703+1706+1722+1715
95 (25+70) x90	91,5-94,5/86-89	1701+1708+1722+1715
95 (30+65) x90	91,5-94,5/86-89	1702+1707+1722+1715
100 (30+70) x90	96,5-99,5/86-89	1702+1708+1722+1715
100 (50+50) x90	96,5-99,5/86-89	1704+1706+1722+1715
100 (20+80) x90	96,5-99,5/86-89	1700+1709+1722+1715
105 (25+80) x90	101,5-104,5/86-89	1701+1709+1722+1715
105 (40+65) x90	101,5-104,5/86-89	1703+1707+1722+1715
110 (30+80) x90	106,5-109,5/86-89	1702+1709+1722+1715
110 (40+70) x90	106,5-109,5/86-89	1703+1708+1722+1715
110 (60+50) x90	106,5-109,5/86-89	1705+1706+1722+1715
115 (50+65) x90	111,5-114,5/86-89	1704+1707+1722+1715
120 (40+80) x90	116,5-119,5/86-89	1703+1709+1722+1715
120 (50+70) x90	116,5-119,5/86-89	1704+1708+1722+1715
125 (60+65) x90	121,5-124,5/86-89	1705+1707+1722+1715
130 (50+80) x90	126,5-129,5/86-89	1704+1709+1722+1715
130 (60+70) x90	126,5-129,5/86-89	1705+1708+1722+1715
140 (60+80) x90	136,5-139,5/86-89	1705+1709+1722+1715

GLASS

fisso + porta a battente con profilo a chiusura magnetica



COMBI D

FISSI	Estensibilità	Art.	PORTE	Cm	Art.
FISSO 20	17/20	1700	PORTA 30	33/35,5	1725+1212
FISSO 25	22/25	1701	PORTA 35	38/40,5	1727+1212
FISSO 30	27/30	1702	PORTA 40	43/45,5	1726+1212
FISSO 40	37/40	1703	PORTA 45	48/50,5	1728+1212
FISSO 50	47/50	1704	PORTA 50	53/55,5	1706+1212
FISSO 60	57/60	1705	PORTA 65	68/70,5	1707+1212
(3 cm regolazione)			PORTA 70	73/75,5	1708+1212
Profilo a chiusura magnetica art.1212			PORTA 80	83/85,5	1709+1212



Pannelli fissi e porte su misura vedi pag. 281

(2,5 cm regolazione)



COMBI D

Abbinamenti con porte 50, 65, 70 e 80

Cm	Fisso	Porta	Apertura	Estensibilità	Articoli
70	20	50	47	70-75,5	1700+1706+1212
75	25	50	47	75-80,5	1701+1706+1212
80	30	50	47	80-85,5	1702+1706+1212
85	20	65	62	85-90,5	1700+1707+1212
90	25	65	62	90-95,5	1701+1707+1212
90	20	70	67	90-95,5	1700+1708+1212
90	40	50	47	90-95,5	1703+1706+1212
95	25	70	67	95-100,5	1701+1708+1212
95	30	65	62	95-100,5	1702+1707+1212
100	30	70	67	100-105,5	1702+1708+1212
100	50	50	47	100-105,5	1704+1706+1212
100	20	80	77	100-105,5	1700+1709+1212
105	25	80	77	105-110,5	1701+1709+1212
105	40	65	62	105-110,5	1703+1707+1212
110	30	80	77	110-115,5	1702+1709+1212
110	40	70	67	110-115,5	1703+1708+1212
110	60	50	47	110-115,5	1705+1706+1212
115	50	65	62	115-120,5	1704+1707+1212
120	40	80	77	120-125,5	1703+1709+1212
120	50	70	67	120-125,5	1704+1708+1212
125	60	65	62	125-130,5	1705+1707+1212
130	50	80	77	130-135,5	1704+1709+1212
130	60	70	67	130-135,5	1705+1708+1212
140	60	80	77	140-145,5	1705+1709+1212

*Permette uso profilo di compensazione in entrambi i lati

*Permette combinazione con laterale fisso STD, estens.minima +0,7/ espansione 3 cm (vedi pag. 202)

Descrizione	Articolo
Profilo espansione +2 cm lato fisso	0218
Profilo espansione +4 cm lato fisso	0029
Magnete espansione +1,2 cm (vedi pag. 285)	1221



Opzione barra 140 cm Art. 1716



GLASS fisso + 2 porte a battente + fisso



Opzione barra 200 + supporti Art. 1717

COMBI G

FISSI	Estensibilità	Art.	
FISSO 20	17/20	1700	
FISSO 25	22/25	1701	
FISSO 30	27/30	1702	
FISSO 40	37/40	1703	
FISSO 50	47/50	1704	
FISSO 60	57/60	1705	

(6 cm regolazione)

PORTE	Cm	Art.	
PORTA 30	30	1725	
PORTA 35	35	1727	
PORTA 40	40	1726	
PORTA 45	45	1728	
PORTA 50	50	1706	
PORTA 65	65	1707	
PORTA 70	70	1708	
PORTA 80	80	1709	

(non regolabile)



Pannelli fissi e porte su misura vedi pag. 281



COMBI G

Abbinamenti con porte 50, 65, 70 e 80

Cm (F+P+P+F)	Estensibilità	Articoli
135(20+50+50+20)	129,5/135,5	1700+1706x2+1700
140(20+50+50+25)	134,5/140,5	1700+1706x2+1701
145(20+50+50+30)	139,5/145,5	1700+1706x2+1702
150(25+50+50+30)	144,5/150,5	1701+1706x2+1702
155(20+50+50+40)	149,5/155,5	1700+1706x2+1703
155(30+50+50+30)	149,5/155,5	1702+1706x2+1702
160(25+50+50+40)	154,5/160,5	1701+1706x2+1703
165(30+50+50+40)	159,5/165,5	1702+1706x2+1703
165(20+65+65+20)	159,5/165,5	1700+1707x2+1700
170(20+65+65+25)	164,5/170,5	1700+1707x2+1701
175(30+50+50+50)	169,5/175,5	1702+1706x2+1704
175(40+50+50+40)	169,5/175,5	1703+1706x2+1703
175(20+50+50+60)	169,5/175,5	1700+1706x2+1705
175(20+65+65+30)	169,5/175,5	1700+1707x2+1702
175(20+70+70+20)	169,5/175,5	1700+1708x2+1700
180(25+50+50+60)	174,5/180,5	1701+1706x2+1705
180(25+65+65+30)	174,5/180,5	1701+1707x2+1702
180(20+70+70+25)	174,5/180,5	1700+1708x2+1701
185(40+50+50+50)	179,5/185,5	1703+1706x2+1704
185(30+50+50+60)	179,5/185,5	1702+1706x2+1705
185(30+65+65+30)	179,5/185,5	1702+1707x2+1702
185(25+70+70+25)	179,5/185,5	1701+1708x2+1701
185(20+70+70+30)	179,5/185,5	1700+1708x2+1702
190(25+65+65+40)	184,5/190,5	1701+1707x2+1703
190(25+70+70+30)	184,5/190,5	1701+1708x2+1702
195(50+50+50+50)	189,5/195,5	1704+1706x2+1704
195(40+50+50+60)	189,5/195,5	1703+1706x2+1705
195(20+65+65+50)	189,5/195,5	1700+1707x2+1704
195(30+65+65+40)	189,5/195,5	1702+1707x2+1703
195(30+70+70+30)	189,5/195,5	1702+1708x2+1702
195(20+70+70+40)	189,5/195,5	1700+1708x2+1703

COMBI G

Abbinamenti con porte 50, 65, 70 e 80

Cm (F+P+P+F)	Estensibilità	Articoli
195(20+80+80+20)	189,5/195,5	1700+1709x2+1700
200(25+65+65+50)	194,5/200,5	1701+1707x2+1704
200(25+70+70+40)	194,5/200,5	1701+1708x2+1703
200(25+80+80+20)	194,5/200,5	1701+1709x2+1700
205(20+65+65+60)	199,5/205,5	1700+1707x2+1705
205(40+65+65+40)	199,5/205,5	1703+1707x2+1703
205(30+65+65+50)	199,5/205,5	1702+1707x2+1704
205(30+70+70+40)	199,5/205,5	1702+1708x2+1703
205(20+70+70+50)	199,5/205,5	1700+1708x2+1704
205(50+50+50+60)	199,5/205,5	1704+1706x2+1705
205(20+80+80+30)	199,5/205,5	1700+1709x2+1702
210(25+65+65+60)	204,5/210,5	1701+1707x2+1705
210(25+70+70+50)	204,5/210,5	1701+1708x2+1704
210(25+80+80+30)	204,5/210,5	1701+1709x2+1702
215(30+65+65+60)	209,5/215,5	1702+1707x2+1705
215(40+65+65+50)	209,5/215,5	1703+1707x2+1704
215(20+70+70+60)	209,5/215,5	1700+1708x2+1705
215(30+70+70+50)	209,5/215,5	1702+1708x2+1704
215(40+70+70+40)	209,5/215,5	1703+1708x2+1703
215(30+80+80+30)	209,5/215,5	1702+1709x2+1702
215(20+80+80+40)	209,5/215,5	1700+1709x2+1703
215(25+70+70+60)	209,5/215,5	1701+1708x2+1705
215(60+50+50+60)	209,5/215,5	1705+1706x2+1705
220(25+80+80+40)	214,5/220,5	1701+1709x2+1703
225(50+65+65+50)	219,5/225,5	1704+1707x2+1704
225(40+65+65+60)	219,5/225,5	1703+1707x2+1705
225(30+70+70+60)	219,5/225,5	1702+1708x2+1705
225(40+70+70+50)	219,5/225,5	1703+1708x2+1704
225(20+80+80+50)	219,5/225,5	1700+1709x2+1704

*Permette unione con laterale fisso STD in entrambi i lati (estens.minima +0,7/ espansione 3 cm), vedi pag. 202

Descrizione	Articolo
Profilo espansione +2 cm	0218
Profilo espansione +4 cm	0029
Magnete espansione +1,2 cm (vedi pag. 285)	1221

GLASS fisso + 2 porte a battente + fisso



Opzione barra 200 + supporti Art. 1717

COMBI G

FISSI	Estensibilità	Art.
FISSO 20	17/20	1700
FISSO 25	22/25	1701
FISSO 30	27/30	1702
FISSO 40	37/40	1703
FISSO 50	47/50	1704
FISSO 60	57/60	1705

(6 cm regolazione)

PORTE	Cm	Art.
PORTA 30	30	1725
PORTA 35	35	1727
PORTA 40	40	1726
PORTA 45	45	1728
PORTA 50	50	1706
PORTA 65	65	1707
PORTA 70	70	1708
PORTA 80	80	1709

(non regolabile)



Pannelli fissi e porte su misura vedi pag. 281



COMBI G

Abbinamenti con porte 50, 65, 70 e 80

Cm (F+P+P+F)	Estensibilità	Articoli
225 (30+80+80+40)	219,5/225,5	1702+1709x2+1703
230 (25+80+80+50)	224,5/230,5	1701+1709x2+1704
235 (50+65+65+60)	229,5/235,5	1704+1707x2+1705
235 (40+70+70+60)	229,5/235,5	1703+1708x2+1705
235 (50+70+70+50)	229,5/235,5	1704+1708x2+1704
235 (20+80+80+60)	229,5/235,5	1700+1709x2+1705
235 (40+80+80+40)	229,5/235,5	1703+1709x2+1703
240 (25+80+80+60)	234,5/240,5	1701+1709x2+1705
245 (60+65+65+60)	239,5/245,5	1705+1707x2+1705
245 (50+70+70+60)	239,5/245,5	1704+1708x2+1705
245 (30+80+80+60)	239,5/245,5	1702+1709x2+1705
245 (40+80+80+50)	239,5/245,5	1703+1709x2+1704
255 (60+70+70+60)	249,5/255,5	1705+1708x2+1705
255 (40+80+80+60)	249,5/255,5	1703+1709x2+1705
255 (50+80+80+50)	249,5/255,5	1704+1709x2+1704
265 (50+80+80+60)	259,5/265,5	1704+1709x2+1705
275 (60+80+80+60)	269,5/275,5	1705+1709x2+1705

*Permette uso profilo di compensazione

*Permette unione con laterale fisso STD in entrambi i lati (estensibilità minima +0,7 cm / regolazione 3 cm), vedi pag. 202

Descrizione	Articolo
Profilo espansione +2 cm	0218
Profilo espansione +4 cm	0029
Magnete espansione +1,2 cm (vedi pag. 285)	1221



Opzione barra 200 + supporti Art. 1717



Braccetto incluso



Cerniera in ottone

GLASS angolare 2 porte a battente + 2 fissi



COMBI H

FISSI	Estensibilità	Art.	
FISSO 20	17/20	1700	
FISSO 25	22/25	1701	
FISSO 30	27/30	1702	
FISSO 40	37/40	1703	
FISSO 50	47/50	1704	
FISSO 60	57/60	1705	

(3 cm regolazione)

PORTE	Cm	Art.	
PORTA 30	30	1725	
PORTA 35	35	1727	
PORTA 40	40	1726	
PORTA 45	45	1728	
PORTA 50	50	1706	
PORTA 65	65	1707	
PORTA 70	70	1708	
PORTA 80	80	1709	

(non regolabile)



Pannelli fissi e porte su misura vedi pag. 281



COMBI H

Abbinamenti con porte 50, 65, 70 e 80

Cm (F+P+P+F)	Estensibilità	Articoli
70X70(20+50+50+20)	67-70/67-70	1700+1706x2+1700
75X75(25+50+50+25)	72-74/72-74	1701+1706x2+1701
80X80(30+50+50+30)	77-80/77-80	1702+1706x2+1702
85X85(20+65+65+20)	82-85/82-85	1700+1707x2+1700
90x90(40+50+50+40)	87-90/87-90	1703+1706x2+1703
90x90(25+65+65+25)	87-90/87-90	1701+1707x2+1701
90x90(20+70+70+20)	87-90/87-90	1700+1708x2+1700
95x95(30+65+65+30)	92-95/92-95	1702+1707x2+1702
100x100(30+70+70+30)	97-100/97-100	1702+1708x2+1702
100x100(50+50+50+50)	97-100/97-100	1704+1706x2+1704
90x70(40+50+50+20)	87-90 / 67-70	1703+1706x2+1700
90x70(25+65+50+20)	87-90 / 67-70	1701+1707+1706+1700
90x70(20+70+50+20)	87-90 / 67-70	1700+1708+1706+1700
95x70(30+65+50+20)	92-95 / 67-70	1702+1707+1706+1700
95x70(25+70+50+20)	92-95 / 67-70	1701+1708+1706+1700
100x70(30+70+50+20)	97-100 / 67-70	1702+1708+1706+1700
100x70(20+80+50+20)	97-100 / 67-70	1700+1709+1706+1700
105x70(40+65+50+20)	102-105 / 67-70	1703+1707+1706+1700
105x70(25+80+50+20)	102-105 / 67-70	1701+1709+1706+1700
110x70(40+70+50+20)	107-110 / 67-70	1703+1708+1706+1700
110x70(30+80+50+20)	107-110 / 67-70	1702+1709+1706+1700
110x70(60+50+50+20)	107-110 / 67-70	1705+1706+1706+1700
115x70(50+65+50+20)	112-115 / 67-70	1704+1707+1706+1700
120x70(50+70+50+20)	117-120 / 67-70	1704+1708+1706+1700
120x70(40+80+50+20)	117-120 / 67-70	1703+1709+1706+1700
125x70(60+65+50+20)	122-125 / 67-70	1705+1707+1706+1700
130x70(50+80+50+20)	127-130 / 67-70	1704+1709+1706+1700
130x70(60+70+50+20)	127-130 / 67-70	1705+1708+1706+1700
140x70(60+80+50+20)	137-140 / 67-70	1705+1709+1706+1700
90x80(40+50+50+30)	87-90 / 77-80	1703+1706x2+1702
90x80(25+65+50+30)	87-90 / 77-80	1701+1707+1706+1702

COMBI H

Abbinamenti con porte 50, 65, 70 e 80

Cm (F+P+P+F)	Estensibilità	Articoli
90x80(20+70+50+30)	87-90 / 77-80	1700+1708+1706+1702
95x80(30+65+50+30)	92-95 / 77-80	1702+1707+1706+1702
95x80(25+70+50+30)	92-95 / 77-80	1701+1708+1706+1702
100x80(30+70+50+30)	97-100 / 77-80	1702+1708+1706+1702
100x80(20+80+50+30)	97-100 / 77-80	1700+1709+1706+1702
105x80(40+65+50+30)	102-105 / 77-80	1703+1707+1706+1702
105x80(25+80+50+30)	102-105 / 77-80	1701+1709+1706+1702
110X80(60+50+50+30)	107-110 / 77-80	1705+1706+1706+1702
110X80(40+70+50+30)	107-110 / 77-80	1703+1708+1706+1702
110X80(30+80+50+30)	107-110 / 77-80	1702+1709+1706+1702
115X80(50+65+50+30)	112-115 / 77-80	1704+1707+1706+1702
120x80(50+70+50+30)	117-120 / 77-80	1704+1708+1706+1702
120x80(40+80+50+30)	117-120 / 77-80	1703+1709+1706+1702
125x80(60+65+50+30)	122-125 / 77-80	1705+1707+1706+1702
130x80(50+80+50+30)	127-130 / 77-80	1704+1709+1706+1702
130x80(60+70+50+30)	127-130 / 77-80	1705+1708+1706+1702
140x80(60+80+50+30)	137-140 / 77-80	1705+1709+1706+1702
95x90(30+65+50+40)	92-95 / 87-90	1702+1707+1706+1703
95x90(25+70+50+40)	92-95 / 87-90	1701+1708+1706+1703
95x90(30+65+65+25)	92-95 / 87-90	1702+1707x2+1701
95x90(25+70+65+25)	92-95 / 87-90	1701+1708+1707+1701
95x90(30+65+70+20)	92-95 / 87-90	1702+1707+1708+1700
95x90(25+70+70+20)	92-95 / 87-90	1701+1708x2+1700
100x90(30+70+50+40)	97-100 / 87-90	1702+1708+1706+1703
100x90(20+80+50+40)	97-100 / 87-90	1700+1709+1706+1703
100x90(30+70+65+25)	97-100 / 87-90	1702+1708+1707+1701
100x90(20+80+65+25)	97-100 / 87-90	1700+1709+1707+1701
100x90(30+70+70+20)	97-100 / 87-90	1702+1708x2+1700
100x90(20+80+70+20)	97-100 / 87-90	1700+1709+1708+1700
105x90(40+65+50+40)	102-105 / 87-90	1703+1707+1706+1703
105x90(25+80+50+40)	102-105 / 87-90	1701+1709+1706+1703

*Permette uso profilo di compensazione in entrambi i lati

Descrizione	Articolo
Profilo espansione +2 cm	0218
Profilo espansione +4 cm	0029

GLASS angolare 2 porte a battente + 2 fissi



Opzione barra + supporti Art. 1716x2+1730

COMBI H

FISSI	Estensibilità	Art.
FISSO 20	17/20	1700
FISSO 25	22/25	1701
FISSO 30	27/30	1702
FISSO 40	37/40	1703
FISSO 50	47/50	1704
FISSO 60	57/60	1705

(3 cm regolazione)

PORTE	Cm	Art.
PORTA 30	30	1725
PORTA 35	35	1727
PORTA 40	40	1726
PORTA 45	45	1728
PORTA 50	50	1706
PORTA 65	65	1707
PORTA 70	70	1708
PORTA 80	80	1709

(non regolabile)



Pannelli fissi e porte su misura vedi pag. 281



COMBI H

Abbinamenti con porte 50, 65, 70 e 80

Cm (F+P+P+F)	Estensibilità	Articoli
105x90(40+65+65+25)	102-105 / 87-90	1703+1707x2+1701
105x90(25+80+65+25)	102-105 / 87-90	1701+1709+1707+1701
105x90(40+65+70+20)	102-105 / 87-90	1703+1707+1708+1700
105x90(25+80+70+20)	102-105 / 87-90	1701+1709+1708+1700
110x90(60+50+50+40)	107-110 / 87-90	1705+1706x2+1703
110x90(40+70+50+40)	107-110 / 87-90	1703+1708+1706+1703
110x90(30+80+50+40)	107-110 / 87-90	1702+1709+1706+1703
110x90(60+50+65+25)	107-110 / 87-90	1705+1706+1707+1701
110x90(40+70+65+25)	107-110 / 87-90	1703+1708+1707+1701
110x90(30+80+65+25)	107-110 / 87-90	1702+1709+1707+1701
110x90(60+50+70+20)	107-110 / 87-90	1705+1706+1708+1700
110x90(40+70+70+20)	107-110 / 87-90	1703+1708x2+1700
110x90(30+80+70+20)	107-110 / 87-90	1702+1709+1708+1700
115x90(50+65+50+40)	112-115 / 87-90	1704+1707+1706+1703
115x90(50+65+65+25)	112-115 / 87-90	1704+1707x2+1701
115x90(50+65+70+20)	112-115 / 87-90	1704+1707+1708+1700
120x90(50+70+50+40)	117-120 / 87-90	1704+1708+1706+1703
120x90(40+80+50+40)	117-120 / 87-90	1703+1709+1706+1703

COMBI H

Abbinamenti con porte 50, 65, 70 e 80

Cm (F+P+P+F)	Estensibilità	Articoli
120x90(50+70+65+25)	117-120 / 87-90	1704+1708+1707+1701
120x90(40+80+65+25)	117-120 / 87-90	1703+1709+1707+1701
120x90(50+70+70+20)	117-120 / 87-90	1704+1708x2+1700
120x90(40+80+70+20)	117-120 / 87-90	1703+1709+1708+1700
125x90(60+65+50+40)	122-125 / 87-90	1705+1707+1706+1703
125x90(60+65+65+25)	122-125 / 87-90	1705+1707x2+1701
125x90(60+65+70+20)	122-125 / 87-90	1705+1707+1708+1700
130x90(60+70+50+40)	127-130 / 87-90	1705+1708+1706+1703
130x90(50+80+50+40)	127-130 / 87-90	1704+1709+1706+1703
130x90(50+80+65+25)	127-130 / 87-90	1704+1709+1707+1701
130x90(60+70+70+20)	127-130 / 87-90	1705+1708x2+1700
130x90(50+80+70+20)	127-130 / 87-90	1704+1709+1708+1700
140x90(60+80+50+40)	137-140 / 87-90	1705+1709+1706+1703
140x90(60+80+65+25)	137-140 / 87-90	1705+1709+1707+1701
140x90(60+80+70+20)	137-140 / 87-90	1705+1709+1708+1700

*Permette uso profilo di compensazione in entrambi i lati

Descrizione	Articolo
Profilo espansione +2 cm	0218
Profilo espansione +4 cm	0029



Opzione barras + supporti Art. 1716x2+1730



GLASS PIEGHEVOLE pg.244

1 fisso + 1 porta pieghevole



GLASS PIEGHEVOLE BLACK pg.244

1 fisso + 1 porta pieghevole



TANDEM pg.248

Pieghevole + fisso e scorrevole



AKORD pg.250

2 porte pieghevoli



PIEGHEVOLE

BOX DOCCIA PIEGHEVOLI



GLASS PIEGHEVOLE verso l'interno del piatto



COMBI 1 chiusura magnetica a parete

Cm	Estensibilità	Articoli
60 (30+30)	57,5/59	1712+1725
70 (40+30)	67,5/69	1713+1725
75 (40+35)	72,5/74	1713+1727
80 (40+40)	77,5/79	1713+1726
80 (50+30)	77,5/79	1714+1725
85 (50+35)	82,5/84	1714+1727
90 (50+40)	87,5/89	1714+1726
95 (50+45)	92,5/94	1714+1728
100 (50+50)	97,5/99	1714+1706

Permette abbinamento con laterale fisso Glass nel lato della porta. L'estensibilità del frontale si ridurrà di 0,5 cm.

Descrizione	Art.
Profilo porta (riduce fino 1 cm l'estensione)	1215
Profilo espansione +2,5 cm	1222
Magnete di espansione +1,2 cm	1221



Opzione porte su misura (vedi pag. 281)

Descrizione	Art.
Porta < 80 cm	1338



COMBI 2 prof. a chiusura magnetica

Cm	Estensibilità	Articoli
65 (30+30)	60/64	1712+1725+1212
75 (40+30)	70/74	1713+1725+1212
80 (40+35)	75/79	1713+1727+1212
85 (40+40)	80/84	1713+1726+1212
85 (50+30)	80/84	1714+1725+1212
90 (50+35)	85/89	1714+1727+1212
95 (50+40)	90/94	1714+1726+1212
100 (50+45)	95/99	1714+1728+1212
105 (50+50)	100/104	1714+1706+1212

Permette combinazione con laterale fisso STD nel lato porta, l'estensibilità minima del frontale aumenta di 0,7 cm

Descrizione	Art.
Profilo porta (riduce fino 1 cm l'estensione)	1215
Profilo espansione lato vetro +2,5 cm	1222
Magnete di espansione +1,2 cm	1221
Prof. esp. lato prof. a chiusura magnetica (+3 cm)	0218
Prof. esp. lato prof. a chiusura magnetica (+6 cm)	0029



GLASS PIEGHEVOLE BLACK verso l'interno del piatto



COMBI 1 chiusura magnetica a parete

Cm	Estensibilità	Articoli
60 (30+30)	57,5/59	1712N+1725
70 (40+30)	67,5/69	1713N+1725
75 (40+35)	72,5/74	1713N+1727
80 (40+40)	77,5/79	1713N+1726
80 (50+30)	77,5/79	1714N+1725
85 (50+35)	82,5/84	1714N+1727
90 (50+40)	87,5/89	1714N+1726
95 (50+45)	92,5/94	1714N+1728
100 (50+50)	97,5/99	1714N+1706

Permette abbinamento con laterale fisso Glass nel lato della porta. L'estensibilità del frontale si ridurrà di 0,5 cm.

Descrizione	Art.
Profilo porta (riduce fino 1 cm l'estensione)	9014
Profilo espansione +2,5 cm	9015
Magnete di espansione +1,2 cm	1221

COMBI 2 prof. a chiusura magnetica

Cm	Estensibilità	Articoli
65 (30+30)	60/64	1712N+1725+9013
75 (40+30)	70/74	1713N+1725+9013
80 (40+35)	75/79	1713N+1727+9013
85 (40+40)	80/84	1713N+1726+9013
85 (50+30)	80/84	1714N+1725+9013
90 (50+35)	85/89	1714N+1727+9013
95 (50+40)	90/94	1714N+1726+9013
100 (50+45)	95/99	1714N+1728+9013
105 (50+50)	100/104	1714N+1706+9013

Permette combinazione con laterale fisso STD nel lato porta, l'estensibilità minima del frontale aumenta di 0,7 cm

Descrizione	Art.
Profilo porta (riduce fino 1 cm l'estensione)	9014
Profilo espansione lato vetro +2,5 cm	9015
Magnete di espansione +1,2 cm	1221
Prof. esp. lato prof. a chiusura magnetica (+3 cm)	9016



Opzione porte su misura (vedi pag. 281)

Descrizione	Art.
Porta < 80 cm	1338

GLASS PIEGHEVOLE verso l'interno del piatto + lat. fisso



COMBI 1 + LATERALE FISSO 70 c/BRACCETTO 1715

Cm	Estensibilità	Articoli	
60 (30+30)x70	57-58,5/66-69	1712+1725+1720F+1715	
70 (40+30)x70	67-68,5/66-69	1713+1725+1720F+1715	
75 (40+35)x70	72-73,5/66-69	1713+1727+1720F+1715	
80 (40+40)x70	77-78,5/66-69	1713+1726+1720F+1715	
80 (50+30)x70	77-78,5/66-69	1714+1725+1720F+1715	
85 (50+35)x70	82-83,5/66-69	1714+1727+1720F+1715	
90 (50+40)x70	87-88,5/66-69	1714+1726+1720F+1715	
95 (50+45)x70	92-93,5/66-69	1714+1728+1720F+1715	
100 (50+50)x70	97-98,5/66-69	1714+1706+1720F+1715	

COMBI 1 + LATERALE FISSO 80 c/BRACCETTO 1715

Cm	Estensibilità	Articoli	
60 (30+30)x80	57-58,5/76-79	1712+1725+1721F+1715	
70 (40+30)x80	67-68,5/76-79	1713+1725+1721F+1715	
75 (40+35)x80	72-73,5/76-79	1713+1727+1721F+1715	
80 (40+40)x80	77-78,5/76-79	1713+1726+1721F+1715	
80 (50+30)x80	77-78,5/76-79	1714+1725+1721F+1715	
85 (50+35)x80	82-83,5/76-79	1714+1727+1721F+1715	
90 (50+40)x80	87-88,5/76-79	1714+1726+1721F+1715	
95 (50+45)x80	92-93,5/76-79	1714+1728+1721F+1715	
100 (50+50)x80	97-98,5/76-79	1714+1706+1721F+1715	

COMBI 1 + LATERALE FISSO 90 c/BRACCETTO 1715

Cm	Estensibilità	Articoli	
60 (30+30)x90	57-58,5/86-89	1712+1725+1722F+1715	
70 (40+30)x90	67-68,5/86-89	1713+1725+1722F+1715	
75 (40+35)x90	72-73,5/86-89	1713+1727+1722F+1715	
80 (40+40)x90	77-78,5/86-89	1713+1726+1722F+1715	
80 (50+30)x90	77-78,5/86-89	1714+1725+1722F+1715	
85 (50+35)x90	82-83,5/86-89	1714+1727+1722F+1715	
90 (50+40)x90	87-88,5/86-89	1714+1726+1722F+1715	
95 (50+45)x90	92-93,5/86-89	1714+1728+1722F+1715	
100 (50+50)x90	97-98,5/86-89	1714+1706+1722F+1715	

Laterali fissi GLASS PIEGHEVOLE 6 mm

Descrizione	Estensibilità	Articoli	
Laterale fisso 70	66 - 69	1720F	
Laterale fisso 80	76 - 79	1721F	
Laterale fisso 90	86 - 89	1722F	

Descrizione	Articoli	
Profilo espansione +2 cm	0218	
Profilo espansione +4 cm	0029	
Profilo espansione +5,5 cm	0219	

Opzioni braccetti

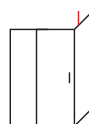

Braccetto 45°
art. 1715

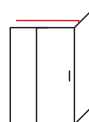

Barra 140 con supporto
art. 1716+1718



Laterali fissi su misura 6 mm (maggiori informazioni a pagina 282)

Descrizione	Articoli	
Laterale fisso su misura OPEN fino 40 cm	1345	
Laterale fisso su misura OPEN da 40 fino 80 cm	1316	
Laterale fisso su misura OPEN da 80 fino 120 cm	1317	

*Tempo di consegna 3 settimane

GLASS PIEGHEVOLE BLACK verso l'interno del piatto + lat. fisso



COMBI 1 + LATERALE FISSO 70 c/BRACCETTO 9017

Cm	Estensibilità	Articoli	
60 (30+30)x70	57-58,5/66-69	1712N+1725+1720FN+9017	
70 (40+30)x70	67-68,5/66-69	1713N+1725+1720FN+9017	
75 (40+35)x70	72-73,5/66-69	1713N+1727+1720FN+9017	
80 (40+40)x70	77-78,5/66-69	1713N+1726+1720FN+9017	
80 (50+30)x70	77-78,5/66-69	1714N+1725+1720FN+9017	
85 (50+35)x70	82-83,5/66-69	1714N+1727+1720FN+9017	
90 (50+40)x70	87-88,5/66-69	1714N+1726+1720FN+9017	
95 (50+45)x70	92-93,5/66-69	1714N+1728+1720FN+9017	
100 (50+50)x70	97-98,5/66-69	1714N+1706+1720FN+9017	

COMBI 1 + LATERALE FISSO 80 c/BRACCETTO 9017

Cm	Estensibilità	Articoli	
60 (30+30)x80	57-58,5/76-79	1712N+1725+1721FN+9017	
70 (40+30)x80	67-68,5/76-79	1713N+1725+1721FN+9017	
75 (40+35)x80	72-73,5/76-79	1713N+1727+1721FN+9017	
80 (40+40)x80	77-78,5/76-79	1713N+1726+1721FN+9017	
80 (50+30)x80	77-78,5/76-79	1714N+1725+1721FN+9017	
85 (50+35)x80	82-83,5/76-79	1714N+1727+1721FN+9017	
90 (50+40)x80	87-88,5/76-79	1714N+1726+1721FN+9017	
95 (50+45)x80	92-93,5/76-79	1714N+1728+1721FN+9017	
100 (50+50)x80	97-98,5/76-79	1714N+1706+1721FN+9017	

COMBI 1 + LATERALE FISSO 90 c/BRACCETTO 9017

Cm	Estensibilità	Articoli	
60 (30+30)x90	57-58,5/86-89	1712N+1725+1722FN+9017	
70 (40+30)x90	67-68,5/86-89	1713N+1725+1722FN+9017	
75 (40+35)x90	72-73,5/86-89	1713N+1727+1722FN+9017	
80 (40+40)x90	77-78,5/86-89	1713N+1726+1722FN+9017	
80 (50+30)x90	77-78,5/86-89	1714N+1725+1722FN+9017	
85 (50+35)x90	82-83,5/86-89	1714N+1727+1722FN+9017	
90 (50+40)x90	87-88,5/86-89	1714N+1726+1722FN+9017	
95 (50+45)x90	92-93,5/86-89	1714N+1728+1722FN+9017	
100 (50+50)x90	97-98,5/86-89	1714N+1706+1722FN+9017	

Laterali fissi GLASS PIEGHEVOLE BLACK 6 mm

Descrizione	Estensibilità	Articoli	
Laterale fisso 70	66 - 69	1720FN	
Laterale fisso 80	76 - 79	1721FN	
Laterale fisso 90	86 - 89	1722FN	

Descrizione	Articoli	
Profilo espansione nero +2 cm	9016	

Opzioni braccetti

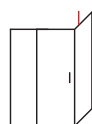

Braccetto 45°
art. 9017

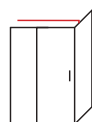

Barra 140 con supporto
art. 9026+9028



Laterali fissi su misura 6 mm (maggiori informazioni a pagina 282)

Descrizione	Articoli		
Laterale fisso su misura OPEN BLACK fino 40 cm	1345N		
Laterale fisso su misura OPEN BLACK da 40 fino 80 cm	1316N		
Laterale fisso su misura OPEN BLACK da 80 fino 120 cm	1317N		

*Tempo di consegna 3 settimane

TANDEM fisso + scorrevole e pieghevole



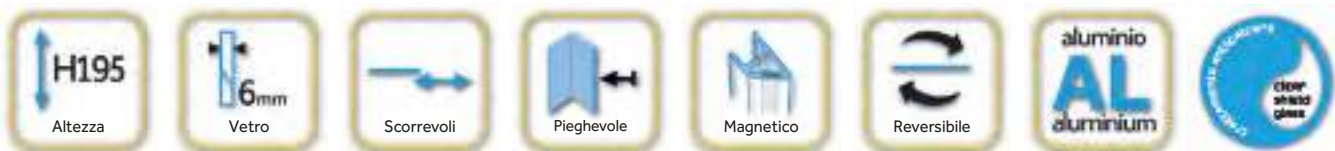

combinazioni TANDEM angolare

F+CxPieg.	Ap.	Estensibilità	Articoli		F+CxPieg.	Ap.	Estensibilità	Articoli	
70x70	59	63-68 / 66,5-69,5	5018+5423+1740		70x75	66	63-68 / 71,5-74,5	5018+5423+1743	
75x70	59	68-73 / 66,5-69,5	5029+5423+1740		75x75	67	68-73 / 71,5-74,5	5029+5423+1743	
80x70	61	73-78 / 66,5-69,5	5019+5423+1740		80x75	68	73-78 / 71,5-74,5	5019+5423+1743	
85x70	63	78-83 / 66,5-69,5	5030+5423+1740		85x75	69	78-83 / 71,5-74,5	5030+5423+1743	
90x70	64	83-88 / 66,5-69,5	5020+5423+1740		90x75	70	83-88 / 71,5-74,5	5020+5423+1743	
95x70	66	88-93 / 66,5-69,5	5031+5423+1740		95x75	72	88-93 / 71,5-74,5	5031+5423+1743	
100x70	67	93-98 / 66,5-69,5	5021+5423+1740		100x75	73	93-98 / 71,5-74,5	5021+5423+1743	
110x70	68	102-107 / 66,5-69,5	5002+5423+1740		110x75	74	102-107 / 71,5-74,5	5002+5423+1743	
120x70	73	113-118 / 66,5-69,5	5022+5423+1740		120x75	79	113-118 / 71,5-74,5	5022+5423+1743	
130x70	74	122-127 / 66,5-69,5	5006+5424+1740		130x75	80	122-127 / 71,5-74,5	5006+5424+1743	
140x70	78	132-137 / 66,5-69,5	5008+5424+1740		140x75	83	132-137 / 71,5-74,5	5008+5424+1743	
F+CxPieg.	Ap.	Estensibilità	Articoli		F+CxPieg.	Ap.	Estensibilità	Articoli	
70X80	68	63-68 / 76,5-79,5	5018+5423+1741		70X90	77	63-68 / 86,5-89,5	5018+5423+1742	
75x80	68	68-73 / 76,5-79,5	5029+5423+1741		75x90	77	68-73 / 86,5-89,5	5029+5423+1742	
80X80	70	73-78 / 76,5-79,5	5019+5423+1741		80x90	79	73-78 / 86,5-89,5	5019+5423+1742	
85x80	71	78-83 / 76,5-79,5	5030+5423+1741		85x90	80	78-83 / 86,5-89,5	5030+5423+1742	
90X80	72	83-88 / 76,5-79,5	5020+5423+1741		90X90	81	83-88 / 86,5-89,5	5020+5423+1742	
95x80	74	88-93 / 76,5-79,5	5031+5423+1741		95x90	82	88-93 / 86,5-89,5	5031+5423+1742	
100X80	75	93-98 / 76,5-79,5	5021+5423+1741		100X90	83	93-98 / 86,5-89,5	5021+5423+1742	
110x80	76	102-107 / 76,5-79,5	5002+5423+1741		110x90	84	102-107 / 86,5-89,5	5002+5423+1742	
120X80	81	113-118 / 76,5-79,5	5022+5423+1741		120X90	88	113-118 / 86,5-89,5	5022+5423+1742	
130X80	82	122-127 / 76,5-79,5	5006+5424+1741		130x90	89	122-127 / 86,5-89,5	5006+5424+1742	
140X80	85	132-137 / 76,5-79,5	5008+5424+1741		140X90	92	132-137 / 86,5-89,5	5008+5424+1742	

Si possono combinare frontali Basic di misure intermedie, estensibilità +2 cm.

Descrizione	Articolo
Profilo espansione +1,5 cm per laterale fisso + scorrevole	5429
Profilo espansione +2,5 per lato piegevole	1222



Box doccia su misura e cristalli speciali

- Box doccia su misura +45%

Si può fabbricare su misura il lato fisso e scorrevole, la porta del lato piegevole con altezza di 195 cm.

*Tempo di consegna 3 settimane

AKORD pieghevole



Frontali AKORD

Descrizione	Apertura	Estensibilità	Articolo	
Frontale AKORD 70 pieghevole	50	66-71	0830	
Frontale AKORD 80 pieghevole	60	76-81	0831	
Frontale AKORD 90 pieghevole	70	86-91	0832	
Frontale AKORD 100 pieghevole	80	96-101	0833	

Descrizione	Articolo	
Profilo espansione +2 cm	0218	
Profilo espansione +4 cm	0029	

**H195**

Altezza



4mm

Vetro



Pieghevole



25cm

Espandibile



Magnetico



Reversibile

aluminio
AL
aluminiumclear
shield
glass

Sistema di ante pieghevoli



Maniglia interna

Combinazioni frontali AKORD + Laterali fissi STD

Cm	Estensibilità	Articoli	
70X70	66,4-68,9/66-69	0830+0814	
80X70	76,4-78,9/66-69	0831+0814	
90X70	86,4-88,9/66-69	0832+0814	
100X70	96,4-98,9/66-69	0833+0814	

Cm	Estensibilità	Articoli	
70X75	66,4-68,9/71-74	0830+0820	
80X75	76,4-78,9/71-74	0831+0820	
90X75	86,4-88,9/71-74	0832+0820	
100X75	96,4-98,9/71-74	0833+0820	

Cm	Estensibilità	Articoli	
70X80	66,4-68,9/76-79	0830+0815	
80X80	76,4-78,9/76-79	0831+0815	
90X80	86,4-88,9/76-79	0832+0815	
100X80	96,4-98,9/76-79	0833+0815	

Cm	Estensibilità	Articoli	
70X90	66,4-68,9/86-89	0830+0816	
80X90	76,4-78,9/86-89	0831+0816	
90X90	86,4-88,9/86-89	0832+0816	
100X90	96,4-98,9/86-89	0833+0816	

*Si può abbinare con il laterale fisso STD (vedi pag. 64)

Descrizione	Articolo	
Profilo espansione +2 cm	0218	
Profilo espansione +4 cm	0029	



Laterali fissi su misura (maggiori informazioni a pagina 282)

Descrizione	Articolo	
Lat. fisso su misura fino 40 cm	1343	
Lat. fisso su misuras da 40 fino 80 cm	1304	
Lat. fisso su misuras da 80 fino 120 cm	1310	

*Tempo di consegna 3 settimane

GME

TRIO pg.254
1 fisso e 2 scorrevoli



BYPASS pg.256
2 scorrevoli



GIRO 360° pg.258

Porta girevole



PORTE DIVISORIE pg.262

Scorrevoli



+SOLUZIONI

ALTRE SOLUZIONI

TRIO 1 fisso + 2 scorrevoli



Adorno in alluminio

Descrizione	Estensibilità	Apertura	Articolo	
Frontale 1 fisso+2scorrevoli TRIO 90	86-91	43-45	1230	
Frontale 1 fisso+2scorrevoli TRIO 95	91-96	46-48	1231	
Frontale 1 fisso+2scorrevoli TRIO 100	96-101	49-51	1232	
Frontale 1 fisso+2scorrevoli TRIO 105	101-106	53-55	1233	
Frontale 1 fisso+2scorrevoli TRIO 110	106-111	56-58	1234	
Frontale 1 fisso+2scorrevoli TRIO 115	111-116	59-61	1235	
Frontale 1 fisso+2scorrevoli TRIO 120	116-121	63-65	1236	
Frontale 1 fisso+2scorrevoli TRIO 125	121-126	66-68	1237	
Frontale 1 fisso+2scorrevoli TRIO 130	126-131	69-71	1238	
Frontale 1 fisso+2scorrevoli TRIO 135	131-136	73-75	1239	
Frontale 1 fisso+2scorrevoli TRIO 140	136-141	76-78	1240	
Frontale 1 fisso+2scorrevoli TRIO 145	141-146	79-81	1243	
Frontale 1 fisso+2scorrevoli TRIO 150	146-151	82-84	1244	
Frontale 1 fisso+2scorrevoli TRIO 155	151-156	85-88	1245	
Frontale 1 fisso+2scorrevoli TRIO 160	156-161	89-91	1246	
Adorno in alluminio 195x3,8 cm			0007	

TRIO frontale + laterale fisso

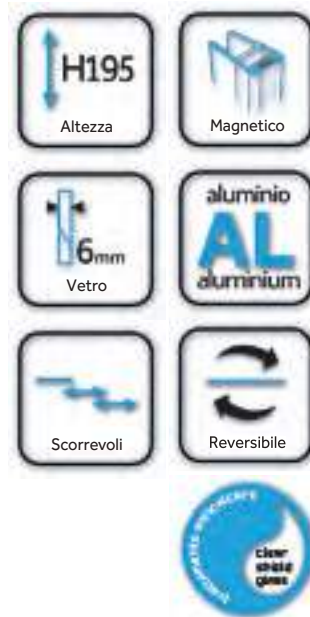

Laterali fissi TRIO

Descrizione	Estensibilità	Art.
Lat. fisso TRIO 70	67-69,5	1241
Lat. fisso TRIO 80	77-79,5	1242
Profilo espansione laterale fisso +3 cm		0218
Profilo espansione laterale fisso +6 cm		0029

*Profilo di compensazione solo per i laterali fissi.

Combinazioni frontali TRIO + laterale fisso

Cm	Estensibilità	Articoli
90x70	87-89,5 / 67-69,5	1230 + 1241
95x70	92-94,5 / 67-69,5	1231 + 1241
100x70	97-99,5 / 67-69,5	1232 + 1241
105x70	102-104,5 / 67-69,5	1233 + 1241
110x70	107-109,5 / 67-69,5	1234 + 1241
115x70	112-114,5 / 67-69,5	1235 + 1241
120x70	117-119,5 / 67-69,5	1236 + 1241
125x70	122-124,5 / 67-69,5	1237 + 1241
130x70	127-129,5 / 67-69,5	1238 + 1241
135x70	132-134,5 / 67-69,5	1239 + 1241
140x70	137-139,5 / 67-69,5	1240 + 1241
145x70	142-144,5 / 67-69,5	1243 + 1241
150x70	147-149,5 / 67-69,5	1244 + 1241
155x70	152-154,5 / 67-69,5	1245 + 1241
160x70	157-159,5 / 67-69,5	1246 + 1241

Cm	Estensibilità	Articoli
90x80	87-89,5 / 77-79,5	1230 + 1242
95x80	92-94,5 / 77-79,5	1231 + 1242
100x80	97-99,5 / 77-79,5	1232 + 1242
105x80	102-104,5 / 77-79,5	1233 + 1242
110x80	107-109,5 / 77-79,5	1234 + 1242
115x80	112-114,5 / 77-79,5	1235 + 1242
120x80	117-119,5 / 77-79,5	1236 + 1242
125x80	122-124,5 / 77-79,5	1237 + 1242
130x80	127-129,5 / 77-79,5	1238 + 1242
135x80	132-134,5 / 77-79,5	1239 + 1242
140x80	137-139,5 / 77-79,5	1240 + 1242
145x80	142-144,5 / 77-79,5	1243 + 1242
150x80	147-149,5 / 77-79,5	1244 + 1242
155x80	152-154,5 / 77-79,5	1245 + 1242
160x80	157-159,5 / 77-79,5	1246 + 1242



Laterali fissi su misura TRIO (maggiori informazioni a pagina 282)

Descrizione	Articoli
Lat. fisso su misura fino 40 cm	1342
Lat. fisso su misura da 40 fino 80 cm	1303
Lat. fisso su misura da 80 fino 120 cm	1309

*Tempo di consegna 3 settimane

BYPASS 2 scorrevoli



Descrizione	Estensibilità	Apertura	Articolo	
Frontale BYPASS 120	108-118	45-55	1270	
Frontale BYPASS 130	118-128	50-60	1271	
Frontale BYPASS 140	128 -138	55-65	1272	
Frontale BYPASS 150	138 -148	60-70	1273	
Frontale BYPASS 160	148 -158	65-75	1274	



Sistema di quattro ruote per cuscinetto

BYPASS frontale + laterale fisso



Laterali fissi BYPASS

Descrizione	Estensibilità	Art.
Laterale fisso BYPASS 70	66-69	1275
Laterale fisso BYPASS 80	76-79	1276

Combinazioni frontali BYPASS + laterale fisso

Cm	Estensibilità	Articoli	P	Cm	Estensibilità	Articoli
120x70	110-120/66-69	1270 + 1275	1208	120x80	110-120/76-79	1270 + 1276
130x70	120-130/66-69	1271 + 1275	1232	130x80	120-130/76-79	1271 + 1276
140x70	130-140/66-69	1272 + 1275	1258	140x80	130-140/76-79	1272 + 1276
150x70	140-150/66-69	1273 + 1275	1280	150x80	140-150/76-79	1273 + 1276
160x70	150-160/66-69	1274 + 1275	1304	160x80	150-160/76-79	1274 + 1276

*Le aperture sono le stesse dei frontali.



Laterali fissi su misura (maggiori informazioni a pagina 282)

Descrizione	Articolo
Laterale fisso su misura BYPASS fino 40 cm	1346
Laterale fisso su misura BYPASS da 40 fino 80 cm	1318
Laterale fisso su misura BYPASS da 80 fino 120 cm	1319

*Tempo di consegna 3 settimane

GIRO 360° 1 porta girevole



COMBI A GIRO 360° 1 porta

Cm	Apertura	Estensibilità	Articoli	
100	46	102,6/107,6	1212+1250+1212+1253	
105	48	107,6/112,6	1212+1251+1212+1253	
110	51	112,6/117,6	1212+1252+1212+1253	

*Permette unione con laterali fissi STD in entrambi i lati estensibilità minima +0,7 cm (vedi pag. 64). È necessario kit accessori art. 1256



COMBI B GIRO 360° 1 fisso + 1 porta

Cm	Fisso	Porta	Apertura	Estensibilità	Articoli
120	20	100	46	117,5/122,5	1200+1250+1212+1254
125	25	100	46	122,5/127,5	1201+1250+1212+1254
125	20	105	48	122,5/127,5	1200+1251+1212+1254
130	30	100	46	127,5/132,5	1202+1250+1212+1254
130	25	105	48	127,5/132,5	1201+1251+1212+1254
130	20	110	51	127,5/132,5	1200+1252+1212+1254
135	30	105	48	132,5/137,5	1202+1251+1212+1254
135	25	110	51	132,5/137,5	1201+1252+1212+1254
140	40	100	46	137,5/142,5	1203+1250+1212+1254
140	30	110	51	137,5/142,5	1202+1252+1212+1254
145	40	105	48	142,5/147,5	1203+1251+1212+1254
150	50	100	46	147,5/152,5	1204+1250+1212+1254
150	40	105	48	147,5/152,5	1203+1252+1212+1254
155	50	100	46	152,5/157,5	1204+1251+1212+1254
160	60	100	46	157,5/162,5	1205+1250+1212+1254
160	50	110	51	157,5/162,5	1204+1252+1212+1254
165	60	105	48	162,5/167,5	1205+1251+1212+1254
170	60	110	51	167,5/172,5	1205+1252+1212+1254

*Permette unione con laterali fissi STD in entrambi i lati estensibilità minima +0,7 cm (vedi pag. 64).
È necessario kit accessori art. 1256

GIRO 360° fisso + porta + fisso



COMBI C Frontale GIRO 360° fisso + porta + fisso

Cm	Apertura	Estensibilità	Articoli	
135 (20+100+20)	46	132,6/137,6	1200+1250+1200+1255	
140 (20+100+25)	46	137,6/142,6	1200+1250+1201+1255	
140 (20+105+20)	48	137,6/142,6	1200+1251+1200+1255	
145 (20+100+30)	46	142,6/147,6	1200+1250+1202+1255	
145 (20+105+25)	48	142,6/147,6	1200+1251+1201+1255	
145 (20+110+20)	51	142,6/147,6	1200+1252+1200+1255	
145 (25+100+25)	46	142,6/147,6	1201+1250+1201+1255	
150 (20+105+30)	48	147,6/152,6	1200+1251+1202+1255	
150 (20+110+25)	51	147,6/152,6	1200+1252+1201+1255	
150 (25+100+30)	46	147,6/152,6	1201+1250+1202+1255	
150 (25+105+25)	48	147,6/152,6	1201+1251+1201+1255	
155 (20+100+40)	46	152,6/157,6	1200+1250+1203+1255	
155 (20+110+30)	51	152,6/157,6	1200+1252+1202+1255	
155 (25+105+30)	48	152,6/157,6	1201+1251+1202+1255	
155 (30+100+30)	46	152,6/157,6	1202+1250+1202+1255	



COMBI C Frontale GIRO 360° fisso + porta + fisso

Cm	Apertura	Estensibilità	Articoli
160 (20+105+40)	48	157,6/162,6	1200+1251+1203+1255
160 (25+100+40)	46	157,6/162,6	1201+1250+1203+1255
160 (30+105+30)	48	157,6/162,6	1202+1251+1202+1255
165 (20+100+50)	46	162,6/167,6	1200+1250+1204+1255
165 (20+110+40)	51	162,6/167,6	1200+1252+1203+1255
165 (25+105+40)	48	162,6/167,6	1201+1251+1203+1255
165 (30+100+40)	46	162,6/167,6	1202+1250+1203+1255
165 (30+110+30)	51	162,6/167,6	1202+1252+1202+1255
170 (20+105+50)	48	167,6/172,6	1200+1251+1204+1255
170 (25+100+50)	46	167,6/172,6	1201+1250+1204+1255
170 (30+105+40)	48	167,6/172,6	1202+1251+1203+1255
175 (20+100+60)	46	172,6/177,6	1200+1250+1205+1255
175 (20+110+50)	51	172,6/177,6	1200+1252+1204+1255
175 (25+105+50)	48	172,6/177,6	1201+1251+1204+1255
175 (30+100+50)	46	172,6/177,6	1202+1250+1204+1255
175 (30+110+40)	51	172,6/177,6	1202+1252+1203+1255
175 (40+100+40)	46	172,6/177,6	1203+1250+1203+1255
180 (20+105+60)	48	177,6/182,6	1200+1251+1205+1255
180 (25+100+60)	46	177,6/182,6	1201+1250+1205+1255
180 (30+105+50)	48	177,6/182,6	1202+1251+1204+1255
180 (40+105+40)	48	177,6/182,6	1203+1251+1203+1255
185 (20+110+60)	51	182,6/187,6	1200+1252+1205+1255
185 (25+105+60)	48	182,6/187,6	1201+1251+1205+1255
185 (30+100+60)	46	182,6/187,6	1202+1250+1205+1255
185 (30+110+50)	51	182,6/187,6	1202+1252+1204+1255
185 (40+100+50)	46	182,6/187,6	1203+1250+1204+1255
185 (40+110+40)	51	182,6/187,6	1203+1252+1203+1255
190 (30+105+60)	48	187,6/192,6	1202+1251+1205+1255
190 (40+105+50)	48	187,6/192,6	1203+1251+1204+1255
195 (30+110+60)	51	192,6/197,6	1202+1252+1204+1255
195 (40+100+60)	46	192,6/197,6	1203+1250+1205+1255
195 (40+110+50)	51	192,6/197,6	1203+1252+1205+1255
195 (50+100+50)	46	192,6/197,6	1204+1250+1204+1255
200 (50+105+50)	48	197,6/200	1204+1251+1204+1255
200 (40+105+60)	48	197,6/200	1203+1251+1205+1255

*Permette unione con laterali fissi STD in entrambi i lati estensibilità minima + 0,7 cm (vedi pag. 64).
 È necessario kit accessori art. 1256

PORTE DIVISORIE CROMO



Descrizione	Art.	
Porta da 75 cm + kit barra/guida 150 cm cromo	1750+1752	
Porta da 85 cm + kit barra/guida 170 cm cromo	1751+1753	

PORTE SU MISURA E SPECIALI	
TRANSP.	OPACO

*Tempo di consegna 3 settimane

PORTE DIVISORIE NERE



PORTE DIVISORIE

Descrizione	Art.
Porta da 75 cm + kit barra/guida 150 cm nera	1750+1754
Porta da 85 cm + kit barra/guida 170 cm nera	1751+1755

PORTE SU MISURA E SPECIALI	
TRANSP.	OPACO

*Tempo di consegna 3 settimane

OPEN pg.266 ●●

OPEN 2 pg.268

GLASS PIEG.



VASCA pg.269

FISSO SCREEN pg.270

BASIC pg.272



VASCA

**PARETI
PER VASCA**

Open 1

A battente vasca

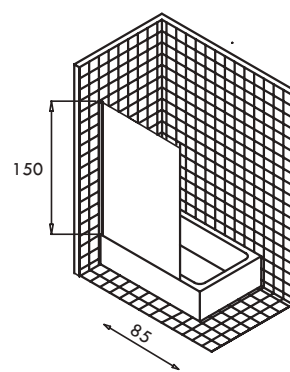

Open 1

Pannello vasca 85x150

Descrizione	Art.
Pannello Open 1 150x85 cm	0121

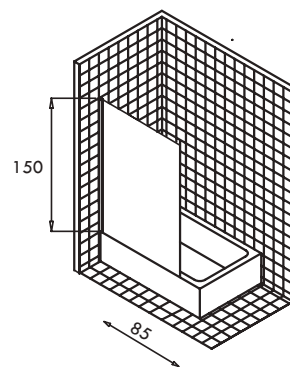

Open 1 Frost Plus

Pannello vasca 85x150

Descrizione	Art.
Pannello Open 1 Frost Plus 150x85 cm	0123



Open 1 Black

Pannello vasca 85x150



VASCA

Descrizione	Art.	
Pannello Open 1 Black 150x85 cm	0121N	



Open 2

Pannello vasca 150x122

Descrizione	Art.
Pannello Open 2 trasparente	0120+0121

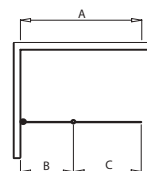
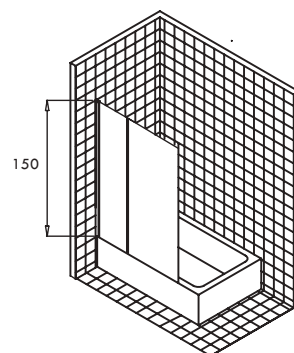

A	B	C
120	37	83

Profilo alluminio cromo
lucido cristallo temperato
6mm elevazione al girare



Open 2 Frost Plus

Pannello vasca 150x122

Descrizione	Art.
Pannello Open 2 frost plus	0122+0123

Glass pieghevole

Vasca 95x150 cm



VASCA

Descrizione	Art.
Glass pieghevole vasca 94,5x150 cm (47+47)	1733



Screen fisso vasca 150x85



Descrizione	Art.
Pannello fisso 150x85 cm	0118

Include braccio orientabile **diritto/45°** est. 60-120 cm

Screen Frost Plus



Descrizione	Art.
Pannello fisso Frost Plus 150x85 cm	0119

Include braccio orientabile **diritto/45°** est. 60-120 cm

Screen Black



Descrizione	Art.
Pannello fisso Black 150x85 cm	SC85N

Include braccio orientabile **diritto/45°** est. 60-120 cm

Screen Black Frost Plus



Descrizione	Art.
Pannello fisso Black Frost plus 150x85 cm	SC85FN

Include braccio orientabile **diritto/45°** est. 60-120 cm



Screen Gold



Descrizione	Art.	
Pannello fisso Gold 150x85 cm	SC85OR	

Include braccio orientabile **diritto/45°** est. 60-120 cm

Screen Gold Frost Plus



Descrizione	Art.	
Pannello fisso Gold Frost plus 150x85 cm	SC85FOR	

Include braccio orientabile **diritto/45°** est. 60-120 cm

Screen White



Descrizione	Art.	
Pannello fisso White 150x85 cm	SC85B	

Include braccio orientabile **diritto/45°** est. 60-120 cm

Screen White Frost Plus



Descrizione	Art.	
Pannello fisso White Frost Plus 150x85 cm	SC85FB	

Include braccio orientabile **diritto/45°** est. 60-120 cm

BASIC VASCA 1 fisso + 1 scorrevole



Piastra di rifinitura opzionale



Doppio cuscinetto di ultima generazione in nylon



Innovativo sistema di guide con pulsante per liberare l'anta e facilitarne la pulizia

BASIC VASCA 1 fisso + 1 scorrevole

Cm	Apertura	TRASPARENTE		FROST PLUS	
		Art.		Art.	
140-145	56-61	5801		6801	
145-150	61-66	5802		6802	
150-155	61-66	5803		6803	
155-160	61-66	5804		6804	
160-165	61-66	5805		6805	
165-170	66-71	5806		6806	

Opzione profilo in titanio

Descrizione	Articoli
Profilo espansione +1,5 cm	5429
Profilo di unione fisso-fisso (indicare il verso), vedi pag. 167	0182
Adorno in alluminio 195x3,8 cm	0007



SU MISURA
E SPECIALE
vedi pag. 280

BASIC VASCA COLORE



PROFILI NERI



PROFILI BIANCHI



Cm	Apert.	TRASPARENTE		FROST PLUS	
		NERO	BIANCO	NERO	BIANCO
140-145	56-61	5801N	5801B	6801N	6801B
145-150	61-66	5802N	5802B	6802N	6802B
150-155	61-66	5803N	5803B	6803N	6803B
155-160	61-66	5804N	5804B	6804N	6804B
160-165	61-66	5805N	5805B	6805N	6805B
165-170	66-71	5806N	5806B	6806N	6806B

Accessori

Descrizione	NERO		BIANCO	
	Art.		Art.	
Profilo espansione +1,5 cm	5477		5473	
Adorno in alluminio 195x3,8 cm	0007N		0007B	
Profilo di unione fisso-fisso (indicare il verso)	0991		0182B	



SU MISURA
E SPECIALE
vedi pag. 280

BASIC VASCA + laterale fisso 8 mm

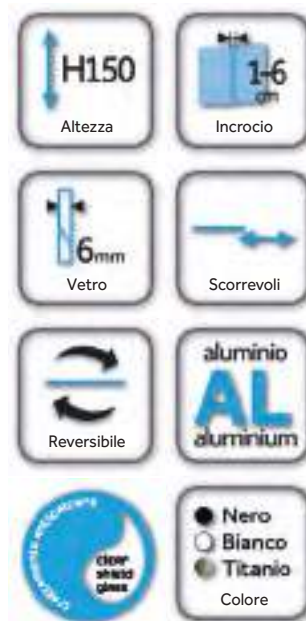

Laterali fissi vasca

Descrizione	Estensibilità
Laterale fisso BASIC 70x150	67-70
Laterale fisso BASIC 75x150	72-74

TRASPARENTE	
Art.	
5065	
5066	

FROST PLUS	
Art.	
6065	
6066	

combinazioni BASIC VASCA + laterale fisso 8 mm

Cm	Estensibilità	Apertura
145x70	140-145/67-70	56-61
150x70	145-150/67-70	61-66
155x70	150-155/67-70	61-66
160x70	155-160/67-70	61-66
165x70	160-165/67-70	61-66
170x70	165-170/67-70	66-71
Cm	Estensibilità	Apertura
145x75	140-145/72-74	56-61
150x75	145-150/72-74	61-66
155x75	150-155/72-74	61-66
160x75	155-160/72-74	61-66
165x75	160-165/72-74	61-66
170x75	165-170/72-74	66-71

TRASPARENTE	
Articoli	
5801+5065	
5802+5065	
5803+5065	
5804+5065	
5805+5065	
5806+5065	
Articoli	
5801+5066	
5802+5066	
5803+5066	
5804+5066	
5805+5066	
5806+5066	

FROST PLUS	
Articoli	
6801+6065	
6802+6065	
6803+6065	
6804+6065	
6805+6065	
6806+6065	
Articoli	
6801+6066	
6802+6066	
6803+6066	
6804+6066	
6805+6066	
6806+6066	

*Profilo di unione fisso-fisso art. 018 (indicare il verso). Opzione profilo in titanio



Laterali fissi su misura

Descrizione
misura fino 40 cm
misura da 40 fino 80 cm
misura de 80 fino 120 cm

TRASPARENTE	
Art.	
1350	
1334	
1335	

FROST PLUS	
Art.	
1350+1312	
1334+1313	
1335+1315	

*Tempo di consegna 3 settimane

BASIC VASCA COLORE + laterale fisso 8 mm

PROFILI NERI

PROFILI BIANCHI



Laterali fissi vasca

Cm	Estens.	TRASPARENTE		FROST PLUS	
		NERO	BIANCO	NERO	BIANCO
Laterale fisso BASIC 70x150	67-70	5065N	5065B	6065N	6065B
Laterale fisso BASIC 75x150	72-74	5066N	5066B	6066N	6066B

Estens. (frontal/lat.fisso)	TRASPARENTE			FROST PLUS		
	NERO	BIANCO	P	NERO	BIANCO	
140-145/67-70	5801N+5065N	5801B+5065B	883	6801N+6065N	6801B+6065B	
145-150/67-70	5802N+5065N	5802B+5065B	889	6802N+6065N	6802B+6065B	
150-155/67-70	5803N+5065N	5803B+5065B	896	6803N+6065N	6803B+6065B	
155-160/67-70	5804N+5065N	5804B+5065B	901	6804N+6065N	6804B+6065B	
160-165/67-70	5805N+5065N	5805B+5065B	910	6805N+6065N	6805B+6065B	
165-170/67-70	5806N+5065N	5806B+5065B	917	6806N+6065N	6806B+6065B	
Estens. (frontal/lat.fisso)	NERO	BIANCO	P	NERO	BIANCO	
140-145/72-74	5801N+5066N	5801B+5066B	913	6801N+6066N	6801B+6066B	
145-150/72-74	5802N+5066N	5802B+5066B	919	6802N+6066N	6802B+6066B	
150-155/72-74	5803N+5066N	5803B+5066B	926	6803N+6066N	6803B+6066B	
155-160/72-74	5804N+5066N	5804B+5066B	931	6804N+6066N	6804B+6066B	
160-165/72-74	5805N+5066N	5805B+5066B	940	6805N+6066N	6805B+6066B	
165-170/72-74	5806N+5066N	5806B+5066B	947	6806N+6066N	6806B+6066B	

*Profilo di unione fisso-fisso NERO art. 0991 (indicare il verso).

*Profilo di unione fisso-fisso BIANCO art. 0182B (indicare il verso).



Laterali fissi su misura

Descrizione	TRASPARENTE		FROST PLUS		Taglio
	Art.		Art.		
misura fino 40 cm	1350N/B		1350N/B+1312		
misura da 40 fino 80 cm	1334N/B		1334N/B+1313		
misura de 80 fino 120 cm	1335N/B		1335N/B+1315		

*Tempo di consegna 3 settimane

VASCA

BASIC SPAZIO VASCA 2 fissi + 2 scorrevoli



Estensibilità	Apertura	TRASPARENTE		FROST PLUS	
		Art.		Art.	
152-162	64-74	5810		6810	
162-172	66-76	5811		6811	
172-182	72-82	5812		6812	

Opzione profilo in titanio

Descrizione	Articoli
profilo espansione +1,5 cm	5429



SU MISURA
E SPECIALE
vedi pag. 280

BASIC SPAZIO VASCA COLORE



PROFILI NERI



PROFILI BIANCHI



VASCA

Estens.	Apert.	TRASPARENTE		FROST PLUS	
		NERO	BIANCO	NERO	BIANCO
152-162	56-61	5810N	5810B	6810N	6810B
162-172	61-66	5811N	5811B	6811N	6811B
172-182	61-66	5812N	5812B	6812N	6812B

Accessori

Descrizione	NERO		BIANCO	
	Art.		Art.	
Profilo espansione +1,5 cm	5477		5473	
Adorno in alluminio 195x3,8 cm	0007N		0007B	



SU MISURA
E SPECIALE
vedi pag. 280

BASIC SPAZIO VASCA + laterale fisso 8 mm



H150 Altezza	1-6 cm Incrocio
6mm Vetro	Scorrevoli
Reversibile	alluminio AL aluminium
	Nero Bianco Titanio Colore

AL MOMENTO DELL'ORDINE, INDICARE IL LATO IN CUI DEVE ESSERE INSTALLATO IL PANNELLO LATERALE FISSO.

Laterali fissi vasca

Descrizione	Estensibilità
Laterale fisso BASIC 70x150	67-70
Laterale fisso BASIC 75x150	72-74

TRASPARENTE	
Art.	
5065	
5066	

FROST PLUS	
Art.	
6065	
6066	

combinazioni frontali BASIC SPAZIO + laterale fisso 8 mm

Cm	Estensibilità	Apertura
160x70	152-162/67-69	64-74
170x70	162-172/67-69	66-76
180x70	172-182/67-69	72-82
Cm	Estensibilità	Apertura
160x75	152-162/72-74	64-74
170x75	162-172/72-74	66-76
180x75	172-182/72-74	72-82

TRASPARENTE	
Articoli	
5810+5065+0182	
5811+5065+0182	
5812+5065+0182	
Articoli	
5810+5066+0182	
5811+5066+0182	
5812+5066+0182	

FROST PLUS	
Articoli	
6810+6065+0182	
6811+6065+0182	
6812+6065+0182	
Articoli	
6810+6066+0182	
6811+6066+0182	
6812+6066+0182	

Indicare dove va il laterale fisso.



Laterali fissi su misura

Descrizione
misura fino 40 cm
misura da 40 fino 80 cm
misura da 80 fino 120 cm

TRASPARENTE	
Art.	
1350+0182	
1334+0182	
1335+0182	

FROST PLUS	
Art.	
1350+0182+1312	
1334+0182+1312	
1335+0182+1312	

Taglio

Indicare dove va il laterale fisso. Tempo di consegna 3 settimane.

BASIC SPAZIO Colore VASCA + laterale fisso 8 mm

PROFILI NERI



PROFILI BIANCHI



Laterali fissi vasca

Cm	Estensibilità	TRASPARENTE		FROST PLUS	
		NERO	BIANCO	NERO	BIANCO
Lat. fisso BASIC 70x150	67-70	5065N	5065B	6065N	6065B
Lat. fisso BASIC 75x150	72-74	5066N	5066B	6066N	6066B

Estensibilità	TRASPARENTE		FROST PLUS	
	NERO	BIANCO	NERO	BIANCO
152-162/67-69	5810N+5065N+0991	5810B+5065B+0182B	6810N+6065N+0991	6810B+6065B+0182B
162-172/67-69	5811N+5065N+0991	5811B+5065B+0182B	6811N+6065N+0991	6811B+6065B+0182B
172-182/67-69	5812N+5065N+0991	5812B+5065B+0182B	6812N+6065N+0991	6812B+6065B+0182B
Estensibilità	NERO	BIANCO	NERO	BIANCO
152-162/72-74	5810N+5066N+0991	5810B+5066B+0182B	6810N+6066N+0991	6810B+6066B+0182B
162-172/72-74	5811N+5066N+0991	5811B+5066B+0182B	6811N+6066N+0991	6811B+6066B+0182B
172-182/72-74	5812N+5066N+0991	5812B+5066B+0182B	6812N+6066N+0991	6812B+6066B+0182B

Indicare dove va il laterale fisso.

Laterali su misura

Descrizione	TRASPARENTE		FROST PLUS	
	NERO	BIANCO	NERO	BIANCO
misura fino 40 cm	1350N+0991	1350B+0182B	1350N+0991+1312	1350B+0182B+1312
misura da 40 fino 80 cm	1334N+0991	1334B+0182B	1334N+0991+1313	1334B+0182B+1313
misura da 80 fino 120 cm	1335N+0991	1335B+0182B	1335N+0991+1315	1335B+0182B+1315

Indicare dove va il laterale fisso. Tempo di consegna 3 settimane.

BOX DOCCIA SCORREVOLI SU MISURA E SPECIALI

Futura Rotary Temple Basic Vitro Twenty

BOX DOCCIA A MISURA TRASPARENTI

- Per calcolare il prezzo incrementare un 45% il prezzo dell'articolo di serie che copre la misura o quella immediatamente superiore.
- Indicare Modello / Articolo / Misura.
- Non si accettano misure superiori alla massima del listino, eccetto Basic fino 220 cm di altezza.

Art. 0868

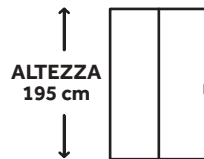

SOLO MODELLO BASIC CROMO

Art. 0871

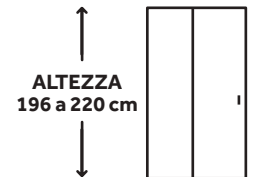

BOX DOCCIA SU MISURA CRISTALLI SPECIALI

Finitura **FROST PLUS ACIDO, PARSOL, CARGLASS / OPACO**

- Per calcolare il prezzo incrementare un 60% il prezzo dell'articolo di serie che copre la misura o quella immediatamente superiore.
- E' necessario indicare la posizione della porta e del fisso.
- Indicare Modello /Articolo/ Misura.
- Non si accettano misure superiori alla massima del listino, eccetto Basic fino 220 cm di altezza.

Art. 0870

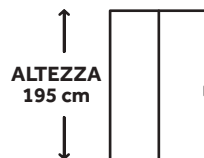

SOLO MODELLO BASIC CROMO

Art. 0872

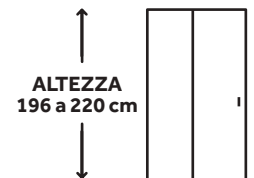

FINITURE CRISTALLI SPECIALI:



FROST PLUS



PARSOL BRONZO



PARSOL FUMÉ



OPACO

TEMPO DI CONSEGNA 20 GIORNI (Non si accettano resi e annullazioni di cristalli su misura)

BOX DOCCIA A BATTENTE SU MISURA

Glass Open Glass Pieghevole

PANNELLI FISSI

MODELLO
PANNELLO FISSO OPEN 6 mm
PANNELLO FISSO OPEN NERO 6 mm
PANNELLO FISSO GLASS 8 mm

Include profili e ferramenta.
Non include braccetto Open e Glass

Larghezza < 40 cm	
Art.	
1345	
1345N	
1339	

Larghezza > 40 e < 80 cm	
Art.	
1316	
1316N	
1336	

Larghezza > 80 e < 120 cm	
Art.	
1317	
1317N	
1337	

PORTE

MODELLO
PORTA GLASS / GLASS PIEGHEVOLE

Larghezza < 80 cm	
Art.	
1338	



OPEN



GLASS



GLASS PIEGHEVOLE

PROFILI E FERRAMENTA

Art.: 1735 | Descrizione: profili e ferramenta per fisso Glass su misura

Art.: 1736 | Descrizione: profili e ferramenta per porta Glass su misura

*Include tutto tranne il vetro

TEMPO DI CONSEGNA 20 GIORNI (Non si accettano resi e annullazioni di cristalli su misura)

LATERALI FISSI SU MISURA

MODELLO	Larghezza <40 cm		Larghezza >40 e <80 cm		Larghezza >80 e <120 cm	
	Art.		Art.		Art.	
Laterale Fisso 8 mm VETRUM	1340		1300		1306	
Laterale Fisso 8 mm MOVING	1341		1301		1307	
Laterale Fisso 8 mm TEMPLE	1349		1302		1308	
Laterale Fisso 6 mm TRIO	1342		1303		1309	
Laterale Fisso 6 mm BYPASS	1346		1318		1319	
Laterale Fisso 8 mm FUTURA	1347		1330		1331	
Laterale Fisso 8 mm ROTARY	1348		1332		1333	
Laterale Fisso 8 mm BASIC fino 195 cm	1350		1334		1335	
Laterale Fisso 8 mm BASIC 195 fino 220 cm	1350H2		1334H2		1335H2	
Laterale Fisso 8 mm BASIC NERA	1350N		1334N		1335N	
Laterale Fisso 8 mm BASIC BIANCA	1350B		1334B		1335B	
Laterale Fisso 8 mm BASIC	1350T		1334T		1335T	
*Laterale fisso 6 mm OPEN / GLASS / GLASS PIEGHEVOLE	1345		1316		1317	
*Laterale fisso 6 mm OPEN NERO	1345N		1316N		1317N	
Laterale fisso 8 mm VITRO	1351		1352		1353	
Laterale fisso 8 mm KENNA	1365		1366		1367	
Laterale fisso 6 mm TWENTY CROMO	1375		1376		1377	
Laterale fisso 6 mm TWENTY BLACK	1375N		1376N		1377N	
Laterale fisso 6 mm TWENTY GOLD	1375OR		1376OR		1377OR	
*Fisso STD 8 mm AKTUAL / PRESTIGE / AKORD / OPEN / GLASS / GLASS PIEGHEVOLE / GIRO	1343		1304		1310	
*Fisso STD NERO 8 mm	1343N		1304N		1310N	

*Braccio non incluso

Aumento per finitura FROST PLUS	1312	1313	1315
---------------------------------	------	------	------

*Indicare posizione del laterale

Aumento per finitura PARSOL	Art. 0870SC - P Laterali fissi su misura
-----------------------------	--

TAGLIO

Art.: 0862 | Descrizione: TAGLIO QUADRATO

*Eccetto Vetrum, Kenna, Prestige, Aktual, Glass pieghevole e Bypass.

(misura totale incluso il profilo)

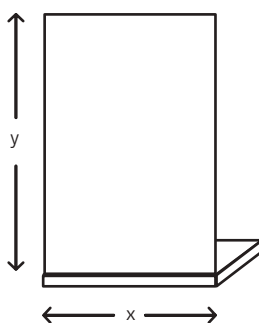

Nel caso di taglio ad incastro, indicare posizione

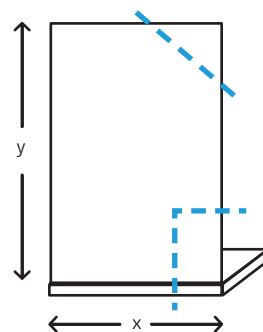

TEMPO DI CONSEGNA 20 GIORNI (Non si accettano resi e annullazioni di cristalli su misura)

SCREEN CROMO SU MISURA

Descrizione	Art.	
Larghezza < 80 cm Altezza fino 195 cm	1305	
Larghezza < 80 cm Altezza 195 a 220 cm	1363	

Descrizione	Art.	
Larghezza di 80 a 120 cm Altezza fino 195 cm	1311	
Larghezza di 80 a 120 cm Altezza 195 a 220 cm	1364	

Questi prezzi includono tutti i componenti per l'assemblaggio, tranne il braccio del modello Screen.

Aumento FROST PLUS Larghezza < 80 cm	1313	
--------------------------------------	-------------	--

Aumento FROST PLUS larghezza 80-120 cm	1315	
--	-------------	--

Tempo di consegna 3 settimane.

Descrizione	Art.	
TAGLIO QUADRATO/Taglio	0862	

(Dimensioni complessive incluso il profilo)

In caso di taglio indicare le misure

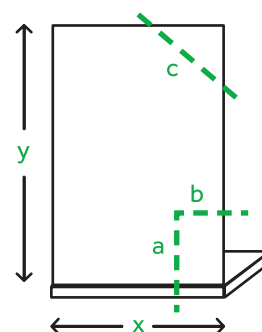
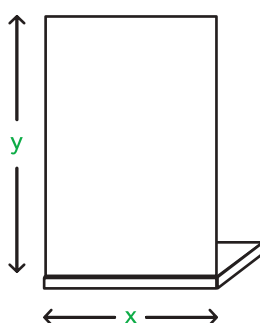

SCREEN cerniera mobile 180° su misura

Descrizione	TRASPARENTE		FROST PLUS	
	Art.		Art.	
Fino a 40 cm	1355		1357	
da 41 a 80 cm	1356		1358	
Altezza 195 a 220 cm	1355H2		1357H2	

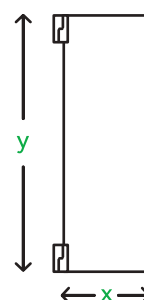

Questi prezzi includono tutti i componenti per il montaggio.

Tempo di consegna 3 settimane.

FINITURE PARSOL IN SCREEN/LATERALI FISSI SU MISURA 8 mm

Art. 0870SC - P Screen su misura



FROST PLUS

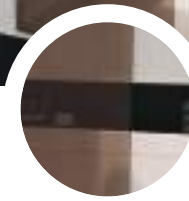

PARSOL BRONZO



PARSOL FUMÉ



OPACO

TEMPO DI CONSEGNA 20 GIORNI (Non si accettano resi e annullazioni di cristalli su misura)

TUBI COMPENSAZIONE MONTAGGIO (INCLUDE COPERCHIO E FERRAMENTA)

Descrizione	Articolo	
Tubo compensazione 40x20x2000 mm cromo	0001	
Tubo compensazione 40x40x2000 mm cromo	0002	
Tubo compensazione 40x40x2000 mm nero OPACO	0002N	
Tubo compensazione 40x40x2000 mm bianco	0002B	
Tubo compensazione 40x60x2000 mm cromo	0003	
Angolare 30x30x2000 mm cromo	0004	
Tubo compensazione INOX 40x20x2000 mm	0009	
Tubo compensazione INOX 40x40x2000 mm	0010	

PROFILI E FERRAMENTA PER LATERALI FISSI SU MISURA

Descrizione	Articolo	
Profili e ferramenta per fissi STD su misura	0821	
Profili e ferramenta per fissi STD NERO su misura	9023	
Profili e ferramenta per fissi TEMPLE su misura	5128	
Profili e ferramenta per fissi TRIO su misura	0006	
Profili e ferramenta per fissi SCREEN su misura	0822	
Profili e ferramenta per fissi SCREEN BLACK su misura	0822N	
Profili e ferramenta per fissi SCREEN WHITE su misura	0822B	
Profili e ferramenta per fissi SCREEN GOLD su misura	0822OR	
Profili e ferramenta per fissi MOVING su misura	1081	
Profili e ferramenta per fissi VETRUM su misura	1080	
Profili e ferramenta per fissi OPEN su misura	0824	
Profili, ferramenta e bracci per fissi OPEN BLACK su misura	9022	
Profili e ferramenta per fissi BYPASS su misura	1277	
Profili e ferramenta per fissi ROTARY su misura	5228	
Profili e ferramenta per fissi FUTURA su misura	5328	
Profili e ferramenta per fissi BASIC su misura	5428	
Profili e ferramenta per fissi BASIC NERA su misura	5492	
Profili e ferramenta per fissi BASIC BIANCA su misura	5588	
Profili e ferramenta per fissi BASIC TITANIO su misura	5567	
Profili e ferramenta per fissi KENNA su misura	6552	
Profili e ferramenta per fissi TWENTY su misura	2025	
Profili e ferramenta per fissi TWENTY NERA su misura	2026	
Profili e ferramenta per fissi TWENTY ORO su misura	2027	

*Include tutto tranne il vetro

FERRAMENTA PER CERNIERA MOBILE 180° SCREEN SU MISURA

Descrizione	Articolo	
Kit cerniera SCREEN CROMO	0330	
Kit cerniera SCREEN BLACK	0330NE	
Kit cerniera SCREEN WHITE	0330BE	
Kit cerniera SCREEN GOLD	0330OE	

*Include tutto tranne il vetro

OPZIONI PER BOX DOCCIA



ART. 1731 / 1732 MANIGLIA ULTRAPIATTA: Guadagna 7 cm il passaggio di entrata in misure intermedie e 2 cm nel resto.



ART. 1221 MAGNETE DI ESPANSIONE +1,2 OPEN: coppia di calamite magnetiche 1,2 cm. più larghe che permettono aumentare l'estensibilità della combinazione di 1,2 cm.



ART. 1072 OPZIONE GUARNIZIONE DEL PROFILO + GUARNIZIONE A BOLLE D'ARIA: Sistema di chiusura con profilo ad "U" a parete e guarnizione di tenuta sulla porta scorrevole.



ART. 0007 GUARNIZIONE IN ALLUMINIO TRIO/BASIC: Piastrina di alluminio lucido per coprire lo spazio tra il limite del piatto ed il profilo di chiusura del Box doccia. Si usa quando il rivestimento ceramico esterna è diverso dall'interno del Box Doccia. Dimensioni 195x3,8 cm.

ART. 0008 GUARNIZIONE ACCIAIO FUTURA/ROTARY/TEMPLE: Piastrina in acciaio lucido per coprire lo spazio tra il limite del piatto ed il profilo di chiusura del Box doccia. Si usa quando il rivestimento ceramico esterna è diverso dall'interno del Box Doccia. Dimensioni 195x3,8 cm.



ART. 1222 PROFILO DI ESPANSIONE PORTA OPEN: Si usa come compensatore del profilo delle porte Open. L'art. 1222 rende anche possibile l'unione del profilo della porta al laterale fisso STD.



ART. 1215 Profilo porta OPEN: sostituendo il profilo 1211 con questo profilo, si riduce fino a 1 cm. l'estensibilità della combinazione.



ART. 1075 PROFILO DELL'UNIONE FISSO+LATERAL FISSO: Su **Vetrum** e **Moving** Nella **Vetrum** e **Moving** permette l'installazione del laterale fisso al fisso del frontale collocato al posto della porta (foto).Valido solo per i laterali fissi su misura; applicato ad un laterale fisso di serie, si perderanno 5 cm. di estensibilità. Nella **Temple/Rotary/Basic** non cambia ne l'articolo ne l'estensibilità della combinazione porta-fisso, e per questo si dovrà indicare nell'ordine la posizione dove si installerà il fisso.

RICAMBI BOX DOCCIA

Nel seguente codice QR incontrate gli esplosi dei diversi formati dei nostri box doccia, separati per modello, per facilitare l'identificazione del ricambio.



GME **BASIS TITANIO**

1800 • 1800/2000 **1800/2000 • 1800**

2700 • 2000/2800 **FREE**

1800 • 2000/2800 • FREE **ANGULAR AL VÉRTICE**

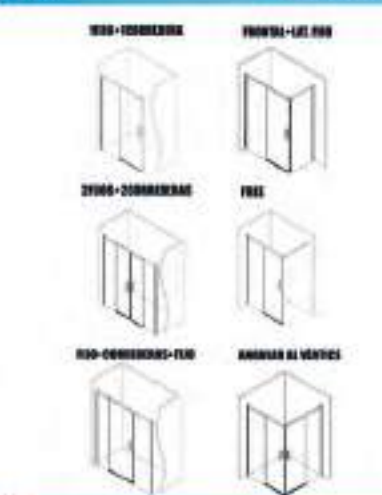

REPOSTOS

GME **BASIS TITANIO 18-18**

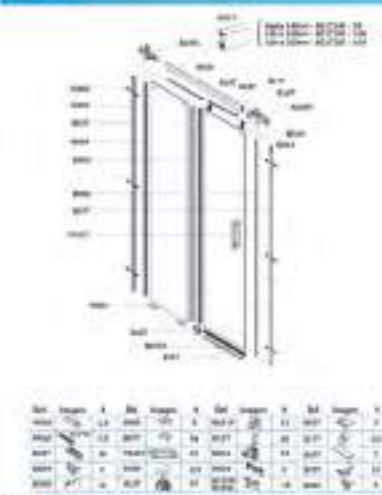

REPOSTOS

GME **BASIS TITANIO 18X20 18-18**



REPOSTOS

GME **BASIS TITANIO**

BASIS 18-18 • 1800 • FREE **BASIS 18-18 FREE**

A **B**

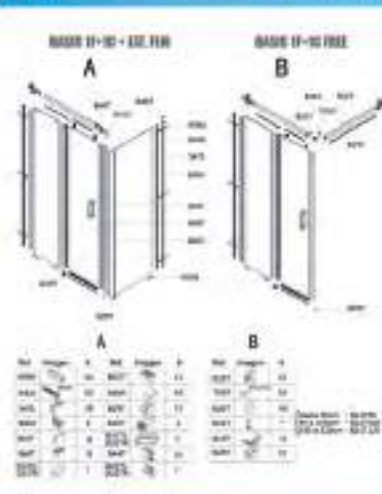

A **B**

REPOSTOS

GME **BASIS TITANIO ANGULAR 18-18**

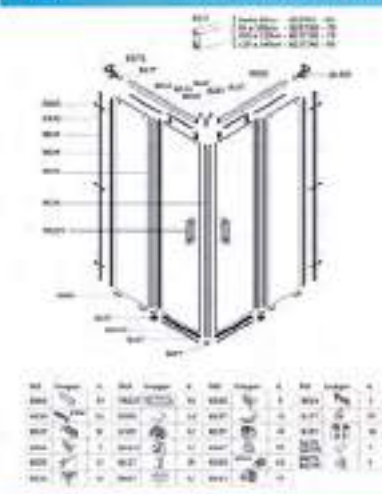

REPOSTOS

GME **BASIS CRISTALES FIJOS Y CORRIENTES**



REPOSTOS

MISURE E PREZZI DEI PROFILI (cm)

PROFILI VERTICALI A PARETE DEL FISSO

AKTUAL / PRESTIGE AKORD/GLASS	VETRUM	MOVING	FUTURA / TEMPLE ROTARY	BASIC VITRO	OPEN GIRO	KENNA
PA3F / PA3U	VE12	MO17	FTR3	B03C*	OP4C*	K040
TWENTY	SCREEN CROMO	SCREEN BLACK/WHITE	SCREEN GOLD			
TW30C*	S01C*	5477 / 5473	S01OR			

PROFILI VERTICALI A PARETE CHIUSURA PORTA







VETRUM MOVING	FUTURA	BASIC / TEMPLE ROTARY	OPEN	TRIO	BYPASS	PRESTIGE	KENNA
VE11	F007	B07C*	R195C*	TR20 / TR19	BY12	PA05	K040

PROFILI ORIZZONTALI SUPERIORI







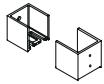

ROTARY	TEMPLE	BASIC	FUTURA	BYPASS	TRIO
Altezza 3,8 Larghezza 0,8	Altezza 4,2 Larghezza 1,3	Altezza 4,8 Larghezza 2,3	Altezza 2,5 Larghezza 3,1	Altezza 4 Larghezza 6	Altezza 5,7 Larghezza 5,7
RO21C180	TE21C180	B21C*210	F21C210	BY74	TR246
AKTUAL PRESTIGE	MOVING	TWENTY	PORTE DIVISORIE		
Altezza 4,5 Larghezza 2	Ø2,5	Altezza 2 Larghezza 3,1			
A599	MO180	TW190C*	PP85C*	PP8C*	

*Se il ricambio che si desidera ordinare è di colore (nero, bianco, oro o titanio), consultare il PDF "ricambi" accedendo dalla pagina 286.



SUPPORTI A PARETE

ROTARY	TEMPLE	BASIC	FUTURA	MOVING	BYPASS	TRIO
						
Altezza 4,5 Larghezza 3,3	Altezza 5,4 Larghezza 3,8	Altezza 5,8 Larghezza 5,2	Altezza 3,5 Larghezza 6	Ø3	Altezza 5,4 Larghezza 7	Altezza 6,2 Larghezza 6,6
RO14	TE14	B15C*	F15	MO09	BY09	TR8





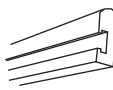

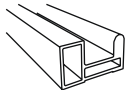
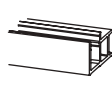

PROFILI ORIZZONTALI INFERIORI (SALVA GOCCIA METALLICI)

FUTURA/TEMPLE ROTARY/BASIC/GLASS	MOVING GIRO	BYPASS	TRIO	AKTUAL	VETRUM	OPEN	GLASS PIEGHEVOLE
							
1x0,6 cm	0,9x0,9 cm	1,6x1,1 cm	1,1x1 cm	0,8x1,2 cm	1,8x0,8 cm	0,6x0,6 cm	1x0,5 cm
B12C*210	MO15	BY07	TR1395	A011	VE08	OP6C*	GP08



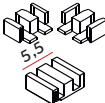

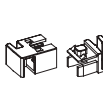
PROFILI ORIZZONTALI INFERIORI

VITRO	TWENTY (frontal)	TWENTY (ANGOLARE e spazio)	KENNA
			
1x2,3 cm	1,6x0,9 cm	1,6x0,9 cm	1,6x2,9 cm
VI14 210	TW2C*	TW44C*	K120

GUIDE INFERIORI

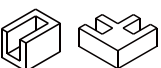
FUTURA	TEMPLE/BASIC ROTARY	MOVING	AKTUAL	VETRUM	BYPASS	TRIO	TWENTY	PTA. DIVIS.	VITRO
									
F011	G10C*	MO14	A009	VE07	BY5 / BY08	TR12	TW14C* / TW15C*	PP9C*	VI29

ANGOLARI INFERIORI

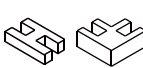
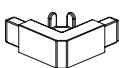
FUTURA/ROTARY TEMPLE/BASIC	MOVING	VETRUM	TRIO	OPEN	GLASS	TWENTY
						
B29C* / B42C*	MO22	VE44 / VE90	TR37	OP3C*	G009 / G011	TW43C*

*Se il ricambio che si desidera ordinare è di colore (nero, bianco, oro o titanio), consultare il PDF "ricambi" accedendo dalla pagina 286.

GUARNIZIONI

GUARNIZIONI DI CHIUSURA A PALLONCINO





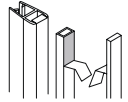

GUARNIZIONI MAGNETICHE ADESIVE

FUTURA/ROTARY/ TEMPLE/BASIC/TRIO

B006







FUTURA/ROTARY/ TEMPLE/BASIC/TRIO

B027 / B66C* / B65C*

KENNA

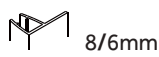
K220









GUARNIZIONI MAGNETICHE

FUTURA / TEMPLE BASIC	VETRUM	MOVING	AKTUAL /PRESTIGE	OPEN / GLASS / GIRO	KENNA	TWENTY
						
B036	VE14	MO20	A017 / A007	OP2C*	K180	TW10







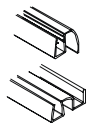

GUARNIZIONI VERTICALI

FUTURA /ROTARY/TEMPLE BASIC/GLASS/TWENTY	VETRUM	MOVING	AKTUAL/PRESTIGE	AKORD	KENNA	
						
B005	VE19	MO19	A006 / A008	AK06	K070	K080











GUARNIZIONI A PRESSIONE

FUTURA /ROTARY TEMPLE / BASIC	VETRUM	MOVING	AKTUAL	SCREEN	OPEN/GLASS	KENNA	TWENTY
							
B004	VE15	MO18	A013	S002	OP05	K050	TW08





GUARNIZIONI INFERIORI

FUTURA/ROTARY TEMPLE / BASIC	TRIO	MOVING	AKTUAL	BYPASS	OPEN GLASS	PANEL OPEN	PANEL GLASS	KENNA
								
B011	TR28 / TR11	MO21	A010	BY06	OP07	GB06	G012	K150

FRENI PORTA



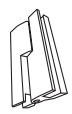



FUTURA	ROTARY	TEMPLE	MOVING	BASIC	AKTUAL PRESTIGE	VITRO	KENNA	TWENTY	PTA. DIVIS.
									
F019	RO15	TE15	M010	B22C*	PA1	VI13	K290	TW28	PP11

CERNIERE



GLASS	GLASS PIEGHEVOLE	SCREEN CERNIERA 180°	SCREEN/OPEN	AKORD
				
HG07	HM03	S31C*	HU01C*	AK21

*Se il ricambio che si desidera ordinare è di colore (nero, bianco, oro o titanio), consultare il PDF "ricambi" accedendo dalla pagina 286.





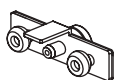
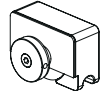
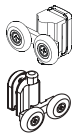

CUSCINETTI (PREZZO PER UNITÁ)

FUTURA	ROTARY	TEMPLE	VETRUM	MOVING	VITRO	AKTUAL / BASIC
						
F014	RO13	TE13	VE10	MO12	VI15	B013

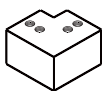

CUSCINETTI (PREZZO PER UNITÁ)

KENNA	TWENTY	PRESTIGE	AKORD	BYPASS	PTA. DIVIS.	
						
K300	TW25C*	TW45C*	P010 / P007	AK19	BY11	PP04

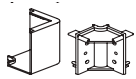

ANGOLARI SUPERIORI (ENTRATA AD ANGOLO)

FUTURA	ROTARY	TEMPLE	MOVING	BASIC	TWENTY	AKTUAL PRESTIGE
						
F022	RO25	TE25	MO23	B25C*	TW27C*	PA 17 / PA16

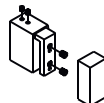
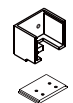
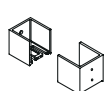
ANGOLARI LATERALE FISSO

ROTARY	TEMPLE	BASIC	BYPASS	TRIO
				
RO44 / RO31	TE44 / TE31	B44C* / B31C*	BY16	TR8

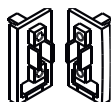
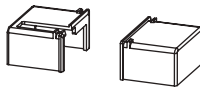
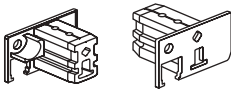
FERMI GUIDA (P PER UNITÁ)

AKTUAL / PRESTIGE	KENNA	TWENTY	PTA. DIVIS.
			
PA02	K09	TW24C*	PP10C*

MANIGLIE

ROTARY / TEMPLE / BASIC GLASS / FUTURA / AKTUAL PRESTIGE / VITRO	MOVING	VETRUM	BYPASS	TRIO	KENNA	TWENTY	PTA. DIVIS.	OPEN
								
22x2,5 cm	21x4 cm	42x2 cm	22x1 cm	28x3 cm	22x4,5 cm	22,5x3 cm		28x3 cm
T22C*	MO13	VE06	BY04	T28C	K200	TW29C*	PP6C*	T28C*

*Se il ricambio che si desidera ordinare è di colore (nero, bianco, oro o titanio), consultare il PDF "ricambi" accedendo dalla pagina 286.

Modelli in vinile polimerico

TEMPO DI CONSEGNA 2
SETTIMANE

TRAZOS



FROST PLUS



FROST



DESERT



METEOR



BAMBÚ



Stampa digitale in vinile

TEMPO DI CONSEGNA 3
SETTIMANE

PERSONALIZZA IL TUO BOX DOCCIA

Grazie alle possibilità che offrono le tecniche moderne di stampa digitale, possiamo ora personalizzare i nostri box doccia. Con questo tipo di stampa, diamo al cristallo un'immagine unica, grazie alla incorporazione della fotografia, disegni, marchi, lettere, simboli e molto altro. Il nostro sistema di stampa digitale, incorpora una pellicola per la protezione e conservazione dell'immagine del vinile.

Se l'immagine è una foto scattata, è richiesta una qualità minima di 5 Mpx e il formato JPG.

Se l'immagine viene creata o è un file immagine, è richiesta una risoluzione minima di 300 dpi, formato JPG/EPS/PDF, colore CMYK e una dimensione superiore al 70% della dimensione finale di stampa (1Mpx/m2). Sono accettabili anche i file vettoriali.



FRONTALE

ANGOLARE



Sagoma cristalli decorati vinile

- | | | | |
|--------------|--------------------------|----------|--------------------------|
| A trazos | <input type="checkbox"/> | E desert | <input type="checkbox"/> |
| B frost plus | <input type="checkbox"/> | F meteor | <input type="checkbox"/> |
| C frost | <input type="checkbox"/> | G bambú | <input type="checkbox"/> |

Cliente
Modello
Descrizione
Articolo

Formato

F: FISSO

P: PORTA

FRONTALI

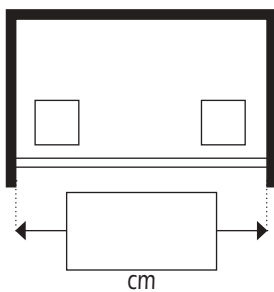

APERTURA ANGOLARE SINISTRA

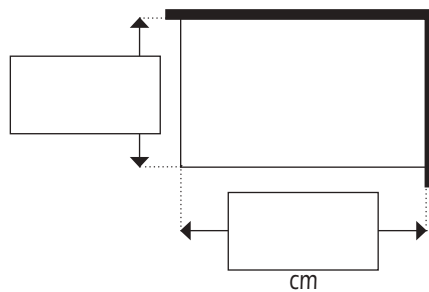

APERTURA ANGOLARE DESTRA

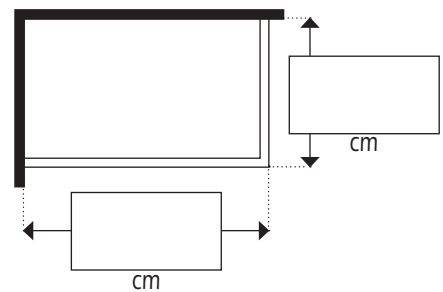

FRONTALE LATERALE FISSO

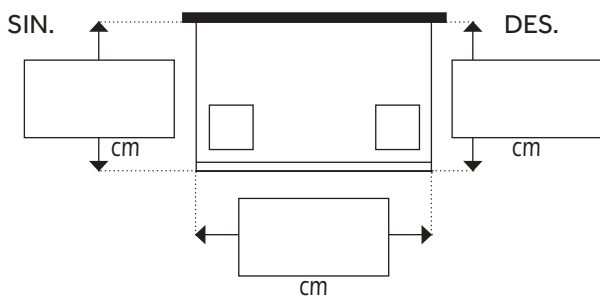

SEMICIRCOLARE

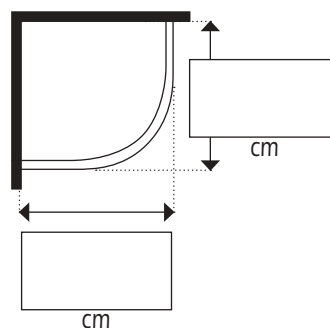

ESEMPIO FRONTALE

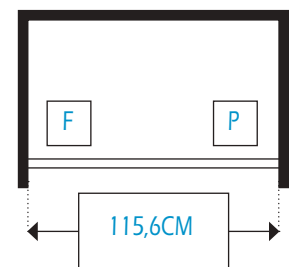

Altezza decorato (max. 118cm)

		art.	
APPLICATI IN GME FROST / FROST PLUS ACIDE	FRONTALE	OFROST1	
	ANGOLARE	OFROST2	
APPLICATI IN GME RESTO DEI VINILE	FRONTALE	0021	
	ANGOLARE	0020	
APPLICAZIONE IN GME DEI VINILE CON IMPRESSIONE	FRONTALE	0019	
	ANGOLARE	0018	
SOLO VINILE, APPLICAZIONE A CURA DEL CLIENTE	FRONTALE	0023	
	ANGOLARE	0022	



GME PRESENTA LA SUA COLLEZIONE DI PIATTI DOCCIA:

Side / Hidden / Ardesia / Style Plus / Resitec:

Quattro modelli di piatti doccia extrapianti realizzati in resina con una nuova formula di carica minerale e gel coat sanitario di ultima generazione che ci permette di produrre un piatto con una notevole riduzione di peso e una maggiore resistenza alla torsione, mantenendo tutti i vantaggi dei piatti in resina. Questi modelli sono realizzati con una finitura ardesiata e hanno un certificato antiscivolo di classe 3, oltre a uno strato di Gel Coat altamente resistente che previene eventuali graffi e la comparsa di organismi come funghi o muffe.



CERTIFICATI

Preoccupati della qualità che offre ai nostri clienti, GME DIVISIÓN BAÑOS SL dispone di certificati che garantiscono la qualità di tutti i suoi prodotti, conformi a tutte le normative europee.

Allo stesso tempo, GME DIVISIÓN BAÑOS SL è associata all'AIDIMME (Istituto Tecnologico), in cui si effettuano ispezioni e test di laboratorio per garantire la qualità e il corretto funzionamento dei prodotti che offre.

Ardesia Plus

Carica minerale di ultima generazione, finitura ardesia
Gel Coat Sanitario ISO NPG



Carta colori RAL

*Tempo di consegna **3** settimane

A	D	B	C
70	35	Fino a 100 cm	30 cm
75	37,5	101-120 cm	35 cm
80	40	121-150 cm	40 cm
90	45	151-170 cm	45 cm
100	50	171-180 cm	50 cm
		190-200 cm	58 cm
		201-220 cm	centro

80x80 / 90x90 / 100x100 hanno un drenaggio al centro

Tecnico

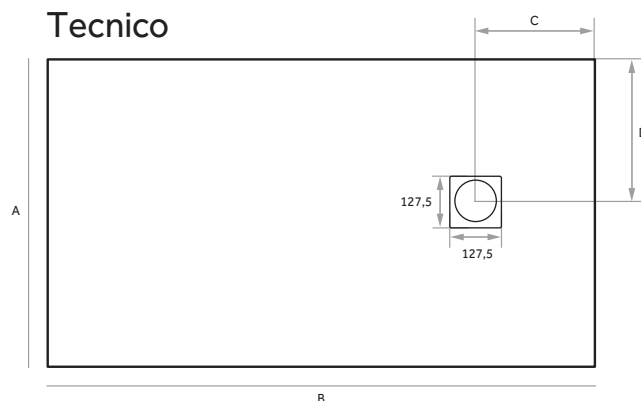



	BIANCO	GRAFITE	BEIGE	GRIGIO
90x70	3886	3887	3888	3889
100x70	3900	3918	3936	3954
110x70	3901	3919	3937	3955
120x70	3902	3920	3938	3956
130x70	3903	3921	3939	3957
140x70	3904	3922	3940	3958
150x70	3905	3923	3941	3959
160x70	3906	3924	3942	3960
170x70	3907	3925	3943	3961
180x70	3908	3926	3944	3962
190x70	3972	3974	3976	3978
200x70	3973	3975	3977	3979
90x75				
90x75	7500	7512	7524	7536
100x75	7501	7513	7525	7537
110x75	7502	7514	7526	7538
120x75	7503	7515	7527	7539
130x75	7504	7516	7528	7540
140x75	7505	7517	7529	7541
150x75	7506	7518	7530	7542
160x75	7507	7519	7531	7543
170x75	7508	7520	7532	7544
180x75	7509	7521	7533	7545
190x75	7510	7522	7534	7546
200x75	7511	7523	7535	7547
80x80				
80x80	3830	3832	3834	3836
100x80	3909	3927	3945	3963
110x80	3910	3928	3946	3964
120x80	3911	3929	3947	3965
130x80	3912	3930	3948	3966
140x80	3913	3931	3949	3967
150x80	3914	3932	3950	3968
160x80	3915	3933	3951	3969
170x80	3916	3934	3952	3970
180x80	3917	3935	3953	3971
190x80	3980	3982	3984	3986
200x80	3981	3983	3985	3987

	BIANCO	GRAFITE	BEIGE	GRIGIO
90x90	3831	3833	3835	3837
120x90	3840	3849	3858	3867
130x90	3841	3850	3859	3868
140x90	3842	3851	3860	3869
150x90	3843	3852	3861	3870
160x90	3844	3853	3862	3871
170x90	3845	3854	3863	3872
180x90	3846	3855	3864	3873
190x90	3847	3856	3865	3874
200x90	3848	3857	3866	3875
100x100				
100x100	3700	3712	3724	3736
110x100	3701	3713	3725	3737
120x100	3702	3714	3726	3738
130x100	3703	3715	3727	3739
140x100	3704	3716	3728	3740
150x100	3705	3717	3729	3741
160x100	3706	3718	3730	3742
170x100	3707	3719	3731	3743
180x100	3708	3720	3732	3744
190x100	3709	3721	3733	3745
200x100	3710	3722	3734	3746
220x100	3711	3723	3735	3747

ARDESIA XXL

Art.

Lungo fino 160 Larghezza 120 cm	3990	
Lungo fino 220 Larghezza 70 a 90 cm	3998	
Lungo fino 220 Larghezza 120 cm	3991	

Tempo di consegna 3 settimane
Scarico centrale in XXL con lunghezza da 100 a 120 cm o lunghezza da 200 a 220 cm.

Supplementi opzionali



PILETTA SCARICO VIEGA
art. 0366



GRIGLIA COLORE
art. 0382



GRIGLIA DI RESINA
art. 0378

PIATTI SU MISURA E TAGLIO

(è richiesto un disegno tecnico)

- Tagli con finitura Gel Coat art. 7777

*Tempo di consegna 2 settimane

- Tagli senza finitura Gel Coat art. 8888

*Tempo di consegna 2 settimane

*Opzione consigliata solo quando la parte tagliata si occultata contro la parete.

Ardesia Plus Semicircolare

Carica minerale di ultima generazione, finitura ardesia
Gel Coat Sanitario ISO NPG



Qualsiasi altro colore della tabella RAL

Fornito con griglia in acciaio inox

***Tempo di consegna 3 settimane**

(Non si accettano cancellazioni una volta effettuato l'ordine.)

A	B	C	R	Kg
800	800	320	550	18
900	900	370	550	19

Tecnico

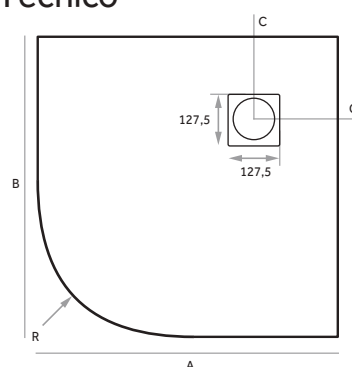



RAGGIO SEMICIRCOLARE STANDARD R 55

	BIANCO	GRAFITE	BEIGE	GRIGIO
80x80	3820	3822	3824	3826
90x90	3821	3823	3825	3827



GRIGLIA DI RESINA
art. 0378



GRIGLIA COLORE
art. 0382

PIATTI SU MISURA E TAGLI (è richiesto un disegno tecnico)

Piatti su misura prezzo in base alla misura immediatamente superiore
ej. 175x76 P.V.P. = 180x80 + taglio 7777/8888

- Tagli con finitura Gel Coat art. 7777
*Tempo di consegna 2 settimane

- Tagli senza finitura Gel Coat art. 8888
*Tempo di consegna 2 settimane
*Opzione consigliata solo quando la parte tagliata si occulta contro la parete.



Style Plus

Carica minerale di ultima generazione, finitura ardesia
Gel Coat Sanitario ISO NPG

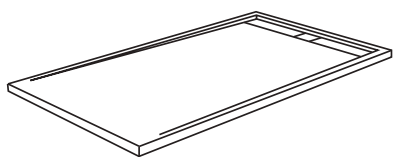

Distanza dalla valvola

Larghezza 70/80 cm 12 cm

Larghezza 90 cm 14 cm



Qualsiasi altro colore della tabella RAL

Fornita con griglia in acciaio inox

***Tempo di consegna 3 settimane**

(Non si accettano cancellazioni una volta effettuato l'ordine.)



	BIANCO	GRAFITE	BEIGE	GRIGIO
90x70	4886	4887	4888	4889
100x70	4900	4918	4936	4954
110x70	4901	4919	4937	4955
120x70	4902	4920	4938	4956
130x70	4903	4921	4939	4957
140x70	4904	4922	4940	4958
150x70	4905	4923	4941	4959
160x70	4906	4924	4942	4960
170x70	4907	4925	4943	4961
180x70	4908	4926	4944	4962
190x70	4972	4974	4976	4978
200x70	4973	4975	4977	4979
<hr/>				
100x80	4909	4927	4945	4963
110x80	4910	4928	4946	4964
120x80	4911	4929	4947	4965
130x80	4912	4930	4948	4966
140x80	4913	4931	4949	4967
150x80	4914	4932	4950	4968
160x80	4915	4933	4951	4969
170x80	4916	4934	4952	4970
180x80	4917	4935	4953	4971
190x80	4980	4982	4984	4986
200x80	4981	4983	4985	4987
<hr/>				
120x90	4840	4849	4858	4867
130x90	4841	4850	4859	4868
140x90	4842	4851	4860	4870
150x90	4843	4852	4861	4871
160x90	4844	4853	4862	4872
170x90	4845	4854	4863	4873
180x90	4846	4855	4864	4874
190x90	4847	4856	4865	4875
200x90	4848	4857	4866	4876



CERTIFICATO DI CLASSE 3

Massima qualificazione
ANTISCIVOLO



Supplementi opzionali

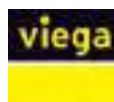

PILETTA SCARICO VIEGA
art. 0366

PIATTI SU MISURA E TAGLI

Piatti su misura prezzo in base alla misura immediatamente superiore
ej. 175x76 P.V.P. = 180X80 + taglio 7777/8888

OPZIONI DI TAGLIO

art. 7777 / Tagli senza initura Gel Coat

*Tempo di consegna 2 settimane

art. 8888 / Tagli senza initura Gel Coat

*Tempo di consegna 2 settimane

*Opzione consigliata solo quando la parte tagliata si occulta contro la parete.



GRIGLIA COLORE
art. 0383



GRIGLIA DI RESINA
art. 0380

PIATTI

Side Plus scarico occulto

Carica minerale di ultima generazione, finitura ardesia
Gel Coat Sanitario ISO NPG



Piletta di scarico Side Plus

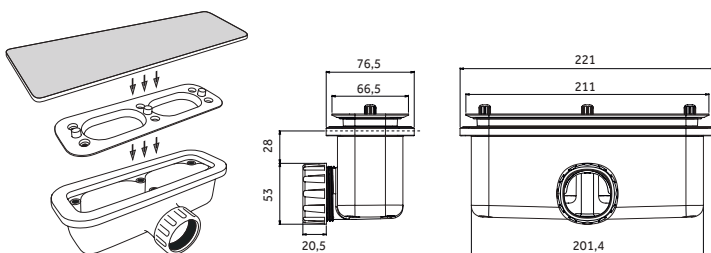

Tecnico

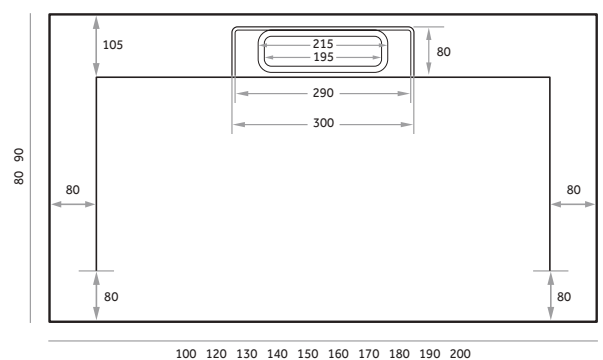



IN STOCK

Bianco RAL 9003

Larghezza 80			Larghezza 90		
Cm	Art.		Cm	Art.	
100x80	6909		-	-	
110x80	6910		-	-	
120x80	6911		120x90	6840	
130x80	6912		130x90	6841	
140x80	6913		140x90	6842	
150x80	6914		150x90	6843	
160x80	6915		160x90	6844	
170x80	6916		170x90	6845	
180x80	6917		180x90	6846	
190x80	6980		190x90	6847	
200x80	6981		200x90	6848	



CERTIFICATO DI CLASSE 3
Massima qualificazione
ANTISCIVOLO



*Include una piletta tecnica extra-piatta (C con file saggio a vite + coperchio di scarico a scomparsa)

PIATTI SU MISURA E TAGLI

Piatti su misura prezzo in base alla misura immediatamente superiore
ej. 175x76 P.V.P. = 180X80 + taglio 7777/8888

OPZIONI DI TAGLIO

art. 7777 / Tagli senza initura Gel Coat

*Tempo di consegna 2 settimane

art. 8888 / Tagli senza initura Gel Coat

*Tempo di consegna 2 settimane

*Questa opzione è disponibile solo quando il ritaglio è nascosto nella parete.

Colore Grigio, Grafite e Beige +45 p

Tempo di consegna 3 settimane



grigio
RAL 7030



grafite
RAL 7016



beige
RAL 9001



Qualsiasi altro colore della tabella RAL

***Tempo di consegna 3 settimane**

(Non si accettano cancellazioni una volta effettuato l'ordine.)

Hidden Plus - riquadro soft

Carica minerale di ultima generazione, finitura ardesia
Gel Coat Sanitario ISO NPG



Tecnico

Distanza dalla valvola

Fino a 100 cm	30 cm
101-130 cm	35 cm
131-150 cm	40 cm
151-170 cm	45 cm
171-200 cm	50 cm

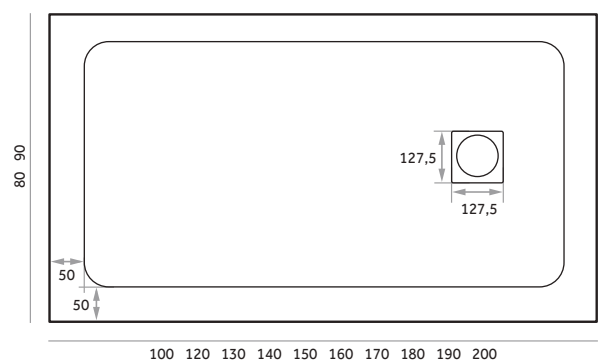
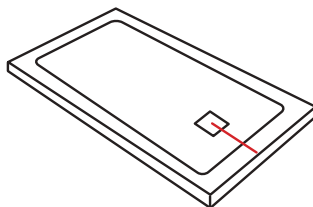



STOCK

Bianco RAL 9003



CERTIFICATO DI CLASSE 3

Massima qualificazione

ANTISCIVOLO



Larghezza 80			Larghezza 90		
Cm	Art.		Cm	Art.	
100x80	5909		-	-	
110x80	5910		-	-	
120x80	5911		120x90	5840	
130x80	5912		130x90	5841	
140x80	5913		140x90	5842	
150x80	5914		150x90	5843	
160x80	5915		160x90	5844	
170x80	5916		170x90	5845	
180x80	5917		180x90	5846	
190x80	5980		190x90	5847	
200x80	5981		200x90	5848	



*Include piletta standard extrapiatta con viti di fissaggio + griglia Inox 316 de 2 mm

PIATTI SU MISURA E TAGLI

(è richiesto un disegno tecnico)

Piatti su misura prezzo in base alla misura immediatamente superiore
ej. 175x76 P.V.P. = 180X80 + taglio **7777/8888**

- Tagli senza initura Gel Coat art. **7777**

*Tempo di consegna 2 settimane

- Tagli senza initura Gel Coat art. **8888**

*Tempo di consegna 2 settimane

*Questa opzione è disponibile solo quando il ritaglio è nascosto nella parete.

Colore Grigio, Grafite e Beige

Tempo di consegna **3** settimane



grigio
RAL 7030

grafite
RAL 7016

beige
RAL 9001

Supplementi opzionali



PILETTA SCARICO VIEGA
art. 0366



GRIGLIA COLORE
art. 0382



GRIGLIA DI RESINA
art. 0378



Qualsiasi altro colore della tabella RAL

Tempo di consegna **3** settimane

(Non si accettano cancellazioni una volta effettuato l'ordine, fornito con griglia in acciaio inox.)

Resitec Rock

Resina tecnica, finitura pietra
Gel Coat Sanitario ISO NPG

+ Leggero
+Caldo al tatto



Per l'installazione seguire i passaggi indicati nel foglio di istruzioni fornito con il prodotto, visto le caratteristiche tecniche del materiale.



Qualsiasi altro colore della tabella RAL

*Tempo di consegna **3** settimane

(Non si accettano cancellazioni una volta effettuato l'ordine, viene fornito con griglia in acciaio inox).



	BIANCO	GRAFITE	BEIGE	GRIGIO
80x80	1490	1492	1494	1496
90x90	1491	1493	1495	1497
100x70	1500	1516	1532	1548
110x70	1501	1517	1533	1549
120x70	1502	1518	1534	1550
130x70	1503	1519	1535	1551
140x70	1504	1520	1536	1552
150x70	1505	1521	1537	1553
160x70	1506	1522	1538	1554
170x70	1507	1523	1539	1555
<hr/>				
100x80	1508	1524	1540	1556
110x80	1509	1525	1541	1557
120x80	1510	1526	1542	1558
130x80	1511	1527	1543	1559
140x80	1512	1528	1544	1560
150x80	1513	1529	1545	1561
160x80	1514	1530	1546	1562
170x80	1515	1531	1547	1563
180x80	1567	1471	1474	1477
190x80	1568	1472	1475	1478
200x80	1569	1473	1476	1479
<hr/>				
100x90	1480	1481	1482	1483
110x90	1484	1485	1486	1487
120x90	1571	1580	1589	1598
130x90	1572	1581	1590	1599
140x90	1573	1582	1591	1600
150x90	1574	1583	1592	1601
160x90	1575	1584	1593	1602
170x90	1576	1585	1594	1603
180x90	1577	1586	1595	1604
190x90	1578	1587	1596	1605
200x90	1579	1588	1597	1606



CERTIFICATO DI CLASSE 3
Massima qualificazione
ANTISCIVOLO

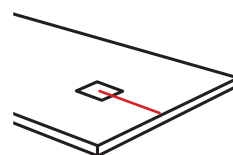

Distanza dalla piletta

Fino a 170 cm	38 cm
171 - 200 cm	40 cm

*Include piletta standard extrapiatta con viti di fissaggio + griglia Inox 316 de 2 mm



PILETTA SCARICO
STANDARD

PIATTI SU MISURA E TAGLI

(disegno tecnico necessario)

Piatti su misura prezzo in base alla misura immediatamente superiore
ej. 175x76 P.V.P. = 180X80 + corte 7777

- Tagli senza nitura Gel Coat art. 7777

*Tempo di consegna 2 settimane

Supplemento



art. 0366

PANNELLI VASCA



NUOVI PANNELLI ARDESIA PLUS +RIGIDO +RESISTENTE

Pannelli in vetroresina e Gel Coat di 0,6 cm di spessore

Finitura [STYLE/ARDESIA/SIDE/HIDDEN](#)

NOVITÀ

Lunghezza	Altezza fino 55		Altezza 55 a 110	
	Articolo		Articolo	
Fino a 70 cm	1411		1415	
Da 71 cm a 100 cm	1412		1416	
Da 101 cm a 140 cm	1413		1417	
Da 141 cm a 208 cm	1414		1418	

Tempo di consegna 3 settimane

PANNELLI VASCA RESITEC ROCK

Pannelli di 1 cm di spessore

[RESITEC ROCK](#) (Pietra)

Lunghezza	Altezza fino 70		Altezza 71 a 110	
	Articolo		Articolo	
Fino a 70 cm	1400		1404	
Da 71 cm a 100 cm	1401		1405	
Da 101 cm a 140 cm	1402		1406	
Da 141 cm a 208 cm	1403		1407	

Tempo di consegna 2 settimane

BATTISCOPA RESITEC / PLUS

Battiscopa fino 9 cm di altezza, al metro lineare

Battiscopa fino 9 cm a 15 cm di altezza, al metro lineare

*Indicare Modello/Misura/Colore

Tempo di consegna 2 settimane

NUOVI PIATTI RIQUADRATI ARDESIA PLUS

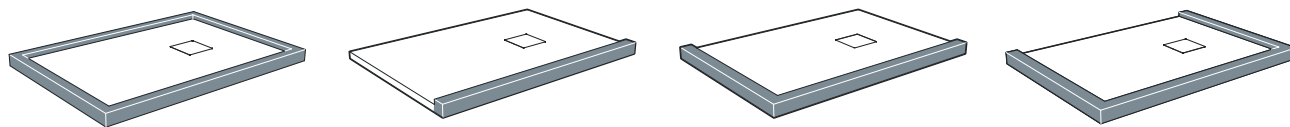

NOVITÀ

Descrizione	Articolo
Riquadro a metro lineare 4x4 cm std	0970

È obbligatorio ricevere un disegno tecnico.
 Per calcolare il prezzo di un piatto riquadrato, aggiungere al prezzo del articolo std, il costo dei metri lineari di riquadro.
 La parte riquadrata del piatto, misurerà 4x4 cm se non diversamente richiesto.

Tempo di consegna 2 settimane.

RICAMBI PIATTI DOCCIA

GRIGLIE



Griglie Inox Ardesia/Hidden



Griglie Inox Style 70

Griglie Inox Style 80

Griglie Inox Style 90



Copertura Side

RICAMBI PILETTA SCARICO



Piletta side art. 0358



Piletta standard art. 0372



Sifone



Cestino



Tappo sifone



Set di gomma

KIT DI RIPARAZIONE



Kit di pittura

Kit di pittura + stucco

Kit di pittura piatto completo

IO[®] by GME

IO[®] è il marchio europeo della rubinetteria progettata e prodotta da GME División Baños S.L. Con oltre 30 anni di esperienza nella commercializzazione e distribuzione di prodotti orientati al condizionamento integrale del bagno.

Il gruppo sviluppa due linee di business generali, una delle quali agisce come delegazione di produttori di primo livello, mentre l'altra produce e commercializza prodotti con il marchio GME.

Griferías IO di GME dispone di tutte le linee di rubinetteria necessarie per l'arredo bagno, la cucina, con un'ampia varietà di formati e colori che seguono le ultime tendenze del mercato.









RHIO
Art. 3165



MARRIOT
Art. 3150



MARRIOT BIANCO
Art. 3150BL



CASSIO NERO
Art. 3070



CASSIO TITANIO
Art. 3105



SIRIO CROMO
Art. 3170



SIRIO ORO
Art. 3172OR



ATRIO
Art. 3076



SIRIO NIQUEL
Art. 3170NK



SIRIO BIANCO
Art. 3170BL



DIOR CROMO
Art. 3120



DIOR NERO
Art. 3125





INVERTER C BIANCA
Art. 3081BL



INVERTER R BIANCA
Art. 3080BL



INVERTER R ORO
Art. 3080OR



INVERTER R NIQUEL
Art. 3080NK



INVERTER R
Art. 3080



INVERTER R NERA
Art. 3135



INVERTER C
Art. 3081



INVERTER C NERA
Art. 3136



QUADRA
Art. 3013



ROUND
Art. 3015



ROUND ÉLITE NERA
Art. 3097



ROUND TITANIO
Art. 3098



ROUND ÉLITE TITANIO
Art. 3099



QUADRA ÉLITE NERA
Art. 3095



RUBINETTERIA INCASSO LAVABO



SIRIO CROMO
Art. 3190



SIRIO ORO
Art. 3190OR



CASSIO BIANCO
Art. 3048BL



ORION NERO
Art. 3029

RUBINETTERIA INCASSO DOCCIA



ROUND CROMO
MONOCOMANDO
Art. 3086



SIRIO BIANCO
MONOCOMANDO
Art. 3086BL+4040BL



SIRIO ORO
MONOCOMANDO
Art. 3086OR+4040OR



ROUND NERO
TERMOSTATICO
Art. 3083



ORION CROMO
MONOCOMANDO
Art. 3088



ORION BIANCO
MONOCOMANDO
Art. 3088BL



ORION CROMO
TERMOSTATICO
Art. 3084



ORION NERO
TERMOSTATICO
Art. 3085





ESTRAIBILE DESIGN CROMO
Art. 3141



DIOR CROMO
Art. 3140



NOAH ACCIAIO
Art. 3184



ROUND ACCIAIO
Art. 3138



ROUND CROMO
Art. 3142



NOAH NERO
Art. 3183



OSMOSIS ACCIAIO
Art. 3137



QUADRA CROMO
Art. 3143



QUADRA ACCIAIO
Art. 3181



SILVER CROMO



ESTRAIBILE ROUND CROMO
Art. 3144



ESTRAIBILE ROUND ACCIAIO
Art. 3180

ESPOSITORI BOX DOCCIA

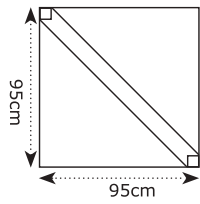

art. GME01
2 Box doccia da **90x90**

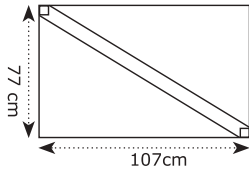

art. GME02
2 Box doccia da **100x70**

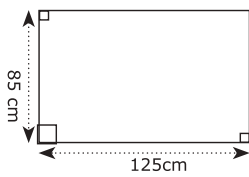

art. GME04
3 Box doccia
Box doccia **120x80**
open/akord **70**
frontale **110**

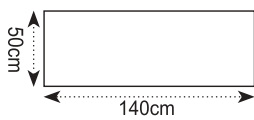

art. GME07
3 Box doccia
frontale **140**



art. GME11

Espositore con pilastri di 2 mt
in alluminio laccato bianco

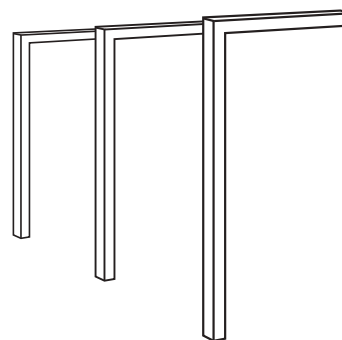

ESPOSITORE PIATTI



art. GME06
2 piatti doccia **120x70**
120x80



ESPOSITORI RUBINETTERIA IO



art. GME03
4 colonne doccia

art. GME09
4 serie di miscelatori
2 colonne doccia / 1 miscelatore+incasso



art. GME10
6 miscelatori IO
1 Colonna doccia



art. GME13
Misura 80x40 cm
9 miscelatori IO



art. GME14
Misura 120x61 cm
14 miscelatori IO



art. GME08
3 miscelatori IO



art. GME12
2 miscelatori IO



COFANETTO
FINITURE
RUBINETTERIA
SIRIO

QME

GME

DIVISION BAÑOS



GME DIVISI3N BAÑOS S.L.

Polígono Ciudad de Mudeco
C/ Pinadeta 16 - 46930
Quart de Poblet - Valencia - España

ATTENZIONE AL CLIENTE

Telf. +34 96 252 18 55
Fax +34 96 252 18 56
italia@gmelorente.com
www.gmelorente.com

ORDINI

italia@gmelorente.com

