

2025 COLORS

BOX DOCCIA

Pronta consegna 100% Stock



CERTIFICAZIONI DI QUALITÀ



Allo stesso tempo, GME DIVISIÓN BAÑOS SL è associata all'istituto tecnologico AIDIMME, dove si effettuano ispezioni e prove di laboratorio per garantire la qualità e il corretto funzionamento dei prodotti offerti.

Preoccupata della qualità che offriamo ai nostri clienti, GME DIVISIÓN BAÑOS SL dispone di certificati che garantiscono la qualità di tutti i suoi prodotti, conformi a tutte le normative europee. **Le nostre finiture metalliche trattate in PVD sono le stesse dei nostri rubinetti IO e possono essere combinate alla perfezione.**

ASOCIADO N° 11666
AIDIMME
INSTITUTO TECNOLÓGICO



I livelli di qualità dei nostri prodotti ci consentono di estendere la garanzia prevista dalla legge a 3 anni. Questa garanzia non copre le parti in plastica o i cuscinetti e decade in caso di uso improprio o di manipolazione dei prodotti.



PRESENZA INTERNAZIONALE

Malta	EE.UU.	Spagna
Romania	Algeria	Portogallo
Mauritania	Slovenia	Andorra
Marocco	Belgio	Francia
Rep. Dominicana	Lussemburgo	Italia
Estonia	Svizzera	Inghilterra
Lituania	Olanda	Grecia
Slovacchia	Polonia	Germania



Impegnati nello sviluppo sostenibile e nell'attenzione all'ambiente, stiamo implementando lo standard ISO 14001, oltre a progetti per ridurre la nostra impronta di carbonio attraverso l'elettrificazione dei nostri macchinari e veicoli, l'approvvigionamento e l'utilizzo di risorse rinnovabili e il riciclo e riutilizzo delle nostre materie prime.

Inoltre, oltre il 75% dei nostri prodotti è già confezionato in imballaggi ecologici di cartone riciclato, riducendo al minimo l'uso della plastica.



GME DIVISIÓN BAÑOS tra le 500 aziende leader nella crescita aziendale nel 2023

CEPYME500 è un'iniziativa di CEPYME che mira a identificare, selezionare e promuovere un insieme di 500 aziende leader nella crescita aziendale, sia per i loro risultati che per la loro capacità di generare valore aggiunto, occupazione, innovazione e proiezione internazionale.

CHI SIAMO

GME DIVISIÓN BAÑOS S.L. è un'azienda familiare valenciana appartenente a LORENTE HOLDING VLC. Con oltre 30 anni di esperienza nella commercializzazione e distribuzione di prodotti orientati al condizionamento integrale del bagno. Il gruppo sviluppa due linee di business generali, una delle quali agisce come delegazione di produttori di primo livello, l'altra produce e commercializza prodotti con il marchio GME.

Grazie al contatto permanente con i nostri clienti attraverso la nostra vasta rete di vendita, sviluppiamo le linee di prodotti da commercializzare per soddisfare le attuali esigenze del mercato, cercando sempre di migliorare l'offerta esistente in termini di prezzo, qualità e servizio.



Il nostro magazzino di 25000 m² ci permette di avere un'ampia scorta di tutti gli articoli presenti in catalogo. Questo, insieme al nostro impegno a preparare gli ordini il giorno stesso in cui li riceviamo, fa sì che la partenza avvenga, in condizioni normali entro le successive 72 ore.

Tutto ciò consente di raggiungere il nostro obiettivo: "La qualità ha un prezzo".



Schede informative



Video Installazione



Registrazione B2B



Elenco dei lotti
Riferimenti dei lotti e la loro suddivisione per componenti e unità (Ej. 5401 = 5001+5434)



Listino 2025
Numero d'ordine, descrizione, peso, volume, RRP, codice tariffario, EAN

7-31

33-57

PORTE SCORREVOLI IN ALLUMINIO



TWENTY ● ● ● ●

KENNA ● ● ●

59-97

99-115



BASIC ● ● ● ● ● ● ●

AKTUAL / PRESTIGE

117-139

141-159

ACCIAIO



VETRUM / TEMPLE / FUTURA / MOVING

SCREEN ● ● ● ● ● ● ●

161-199



BATTENTE OPEN ● ●

201-237



BATTENTE GLASS ● ● ● ● ● ● ● ●

239-253



PIEGHEVOLI ● ●

255-263



+SOLUZIONI

265-287



VASCHE ● ● ● ● ● ● ● ●

311-321



PIATTI DOCCIA

twenty

20mm

“Tecnologia e bellezza con soli 20 mm di profilo e Soft Close”

-  8-13 CROMO
-  14-19 NERO
-  20-25 ORO
-  26-31 RAME

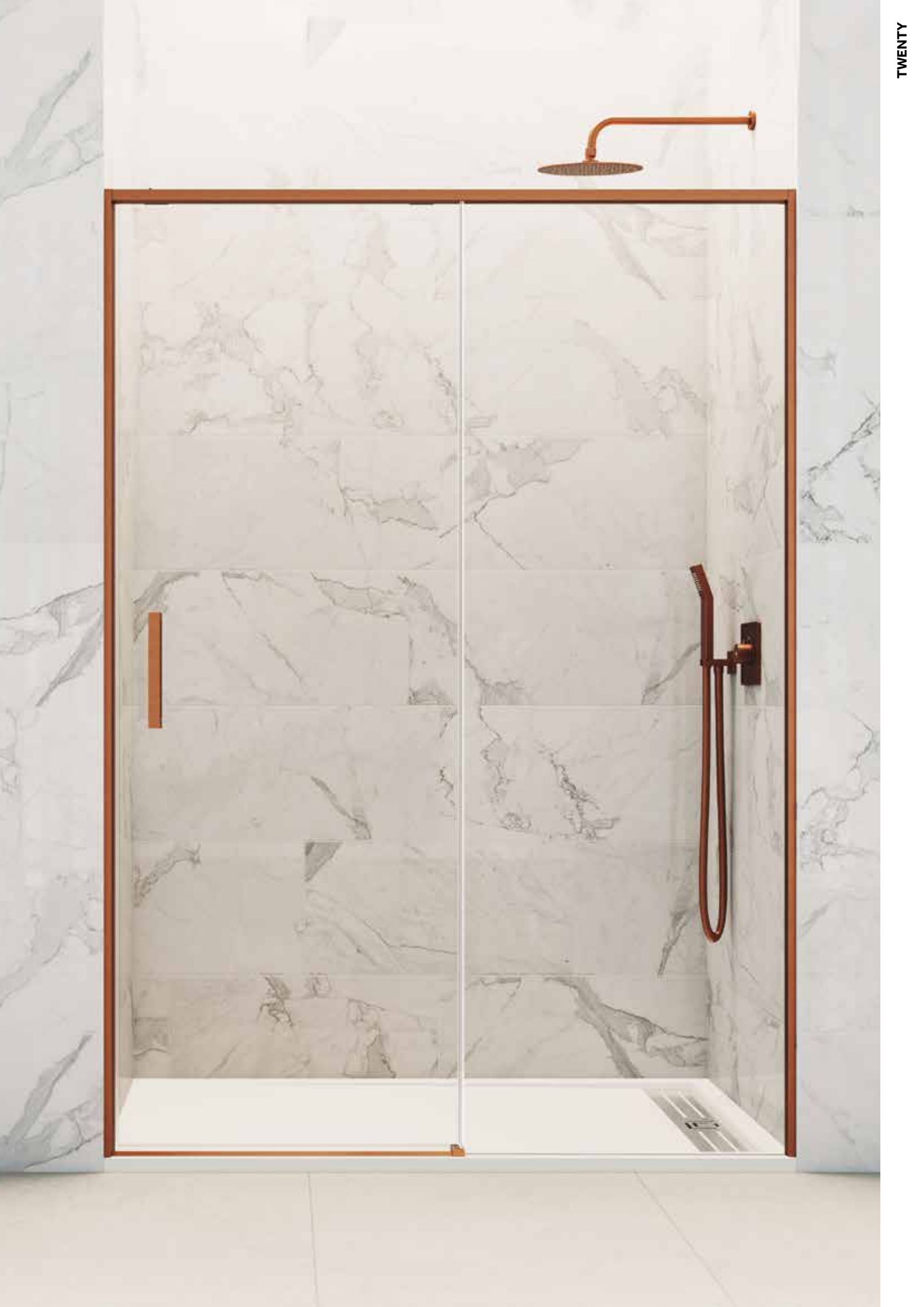

TWENTY 1 fisso+1 scorrevole



Chiusura/apertura soft close



Cuscinetto occulto



Guida sganciabile



Opzione maniglia extrapiatta

Descrizione	Estensibilità	Apertura	Art.
Frontale doccia TWENTY 1F1S 115	110-115	43-48	1999+2021
Frontale doccia TWENTY 1F1S 120	115-120	46-51	2000+2021
Frontale doccia TWENTY 1F1S 125	120-125	49-54	2001+2021
Frontale doccia TWENTY 1F1S 130	125-130	51-56	2002+2021
Frontale doccia TWENTY 1F1S 135	130-135	54-59	2003+2021
Frontale doccia TWENTY 1F1S 140	135-140	56-61	2004+2021
Frontale doccia TWENTY 1F1S 145	140-145	59-64	2005+2021
Frontale doccia TWENTY 1F1S 150	145-150	61-66	2006+2021
Frontale doccia TWENTY 1F1S 155	150-155	64-69	2007+2022
Frontale doccia TWENTY 1F1S 160	155-160	66-71	2008+2022
Frontale doccia TWENTY 1F1S 165	160-165	69-74	2009+2022
Frontale doccia TWENTY 1F1S 170	165-170	71-76	2010+2022
Frontale doccia TWENTY 1F1S 175	170-175	74-79	2011+2022
Frontale doccia TWENTY 1F1S 180	175-180	76-81	2012+2022

*Composizione per articoli/prezzo a pagina 306

TWENTY 2 fissi+2 scorrevoli

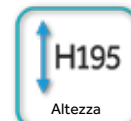

Descrizione	Estensibilità	Apertura	Art.
Frontale doccia TWENTY 2F2S 140 (75+75)	131-141	44-54	2031+2031+2042
Frontale doccia TWENTY 2F2S 150 (80+80)	141-151	49-59	2032+2032+2042
Frontale doccia TWENTY 2F2S 160 (85+85)	151-161	54-64	2033+2033+2042
Frontale doccia TWENTY 2F2S 170 (90+90)	161-171	59-69	2034+2034+2042
Frontale doccia TWENTY 2F2S 180 (95+95)	171-181	64-74	2035+2035+2042
Frontale doccia TWENTY 2F2S 190 (100+100)	181-191	69-79	2036+2036+2042
Opzione maniglia extrapiatta 39,5x1,4x1,6cm			2052

*Permette laterale fisso in entrambi i lati, vedi pagina 12



	TRASPARENTE	FROST PLUS PARSOL / OPACO
Box doccia su misura e cristalli speciali	+45%	+60%

*Tempo di consegna 3 settimane (maggiori informazioni a pag. 288)

TWENTY apertura angolare



Box doccia su misura e cristalli speciali

TRASPARENTE

+45%

FROST PLUS
PARSOL / OPACO

+60%

*Tempo di consegna 3 settimane (maggiori informazioni a pag. 288)

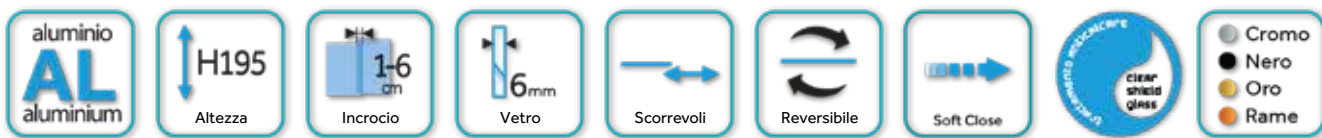

combinazioni **TWENTY** apertura angolare

Cm	Estensibilità	Apertura	Art.
70X70	65-70/65-70	30-35	2030+2030+2038
75X70	70-75/65-70	32-37	2031+2030+2038
80X70	75-80/65-70	34-39	2032+2030+2038
85X70	80-85/65-70	36-41	2033+2030+2038
90X70	85-90/65-70	38-43	2034+2030+2038
95X70	90-95/65-70	40-45	2035+2030+2038
100X70	95-100/65-70	42-47	2036+2030+2038
120X70	115-120/65-70	52-57	2037+2030+2038
Cm	Estensibilità	Apertura	Art.
75X75	70-75/70-75	34-39	2031+2031+2038
80X75	75-80/70-75	36-41	2032+2031+2038
85X75	80-85/70-75	38-43	2033+2031+2038
90X75	85-90/70-75	40-45	2034+2031+2038
95X75	90-95/70-75	42-47	2035+2031+2038
100X75	95-100/70-75	45-50	2036+2031+2038
120X75	115-120/70-75	54-59	2037+2031+2038
Cm	Estensibilità	Apertura	Art.
80X80	75-80/75-80	38-43	2032+2032+2038
85X80	80-85/75-80	40-45	2033+2032+2038
90X80	85-90/75-80	42-47	2034+2032+2038
95X80	90-95/75-80	45-50	2035+2032+2038
100X80	95-100/75-80	47-52	2036+2032+2038
120X80	115-120/75-80	56-61	2037+2032+2038
Cm	Estensibilità	Apertura	Art.
90X90	85-90/85-90	47-52	2034+2034+2038
95X90	90-95/85-90	49-54	2035+2034+2038
100X90	95-100/85-90	50-55	2036+2034+2038
120X90	115-120/85-90	60-65	2037+2034+2038

*Composizione per articoli/prezzo a pagina 306



Innovativo sistema antiribaltamento



Cuscinetto occulto



Doppia maniglia metallica



Apertura soft close

TWENTY frontale + laterale fisso 6 mm



Descrizione	Estensibilità	Art.
Laterale fisso TWENTY 70	66,5-69,5	2013
Laterale fisso TWENTY 75	71,5-74,5	2014
Laterale fisso TWENTY 80	76,5-79,5	2015
Laterale fisso TWENTY 90	86,5-89,5	2016

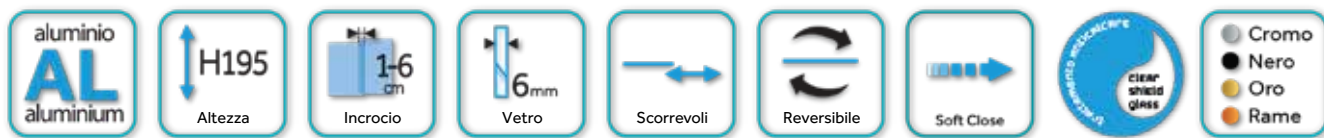

combinazioni frontali **TWENTY** + laterale fisso 6 mm

Cm	Estensibilità	Art.	Cm	Estensibilità	Art.
115x70	110-115/66,5-69,5	1999+2021+2013	115x75	110-115/71,5-74,5	1999+2021+2014
120x70	115-120/66,5-69,5	2000+2021+2013	120x75	115-120/71,5-74,5	2000+2021+2014
125x70	120-125/66,5-69,5	2001+2021+2013	125x75	120-125/71,5-74,5	2001+2021+2014
130x70	125-130/66,5-69,5	2002+2021+2013	130x75	125-130/71,5-74,5	2002+2021+2014
135x70	130-135/66,5-69,5	2003+2021+2013	135x75	130-135/71,5-74,5	2003+2021+2014
140x70	135-140/66,5-69,5	2004+2021+2013	140x75	135-140/71,5-74,5	2004+2021+2014
145x70	140-145/66,5-69,5	2005+2021+2013	145x75	140-145/71,5-74,5	2005+2021+2014
150x70	145-150/66,5-69,5	2006+2021+2013	150x75	145-150/71,5-74,5	2006+2021+2014
155x70	150-155/66,5-69,5	2007+2022+2013	155x75	150-155/71,5-74,5	2007+2022+2014
160x70	155-160/66,5-69,5	2008+2022+2013	160x75	155-160/71,5-74,5	2008+2022+2014
165x70	160-165/66,5-69,5	2009+2022+2013	165x75	160-165/71,5-74,5	2009+2022+2014
170x70	165-170/66,5-69,5	2010+2022+2013	170x75	165-170/71,5-74,5	2010+2022+2014
175x70	170-175/66,5-69,5	2011+2022+2013	175x75	170-175/71,5-74,5	2011+2022+2014
180x70	175-180/66,5-69,5	2012+2022+2013	180x75	175-180/71,5-74,5	2012+2022+2014
Cm	Estensibilità	Art.	Cm	Estensibilità	Art.
115x80	110-115/76,5-79,5	1999+2021+2015	115x90	110-115/86,5-89,5	1999+2021+2016
120x80	115-120/76,5-79,5	2000+2021+2015	120x90	115-120/86,5-89,5	2000+2021+2016
125x80	120-125/76,5-79,5	2001+2021+2015	125x90	120-125/86,5-89,5	2001+2021+2016
130x80	125-130/76,5-79,5	2002+2021+2015	130x90	125-130/86,5-89,5	2002+2021+2016
135x80	130-135/76,5-79,5	2003+2021+2015	135x90	130-135/86,5-89,5	2003+2021+2016
140x80	135-140/76,5-79,5	2004+2021+2015	140x90	135-140/86,5-89,5	2004+2021+2016
145x80	140-145/76,5-79,5	2005+2021+2015	145x90	140-145/86,5-89,5	2005+2021+2016
150x80	145-150/76,5-79,5	2006+2021+2015	150x90	145-150/86,5-89,5	2006+2021+2016
155x80	150-155/76,5-79,5	2007+2022+2015	155x90	150-155/86,5-89,5	2007+2022+2016
160x80	155-160/76,5-79,5	2008+2022+2015	160x90	155-160/86,5-89,5	2008+2022+2016
165x80	160-165/76,5-79,5	2009+2022+2015	165x90	160-165/86,5-89,5	2009+2022+2016
170x80	165-170/76,5-79,5	2010+2022+2015	170x90	165-170/86,5-89,5	2010+2022+2016
175x80	170-175/76,5-79,5	2011+2022+2015	175x90	170-175/86,5-89,5	2011+2022+2016
180x80	175-180/76,5-79,5	2012+2022+2015	180x90	175-180/86,5-89,5	2012+2022+2016

Le aperture sono le stesse dei frontali. Permette laterale fisso in entrambi i lati.



Laterali fissi su misura (maggiori informazioni a pagina 291)

Descrizione	Art.
Laterale fisso su misura TWENTY fino 40 cm	1375
Laterale fisso su misura TWENTY da 40 fino 80 cm	1376
Laterale fisso su misura TWENTY da 80 fino 120 cm	1377

*Tempo di consegna 3 settimane

TWENTY NERA 1 fisso+1 scorrevole



Chiusura/apertura soft close



Cuscinetto occulto



Opzione maniglia extrapiatta



*Set di 2 gomme verticali nere art. 0014

Descrizione	Estensibilità	Apertura	Art.
Frontale doccia TWENTY 1F1S NERA 115	110-115	43-48	1999+2023
Frontale doccia TWENTY 1F1S NERA 120	115-120	46-51	2000+2023
Frontale doccia TWENTY 1F1S NERA 125	120-125	49-54	2001+2023
Frontale doccia TWENTY 1F1S NERA 130	125-130	51-56	2002+2023
Frontale doccia TWENTY 1F1S NERA 135	130-135	54-59	2003+2023
Frontale doccia TWENTY 1F1S NERA 140	135-140	56-61	2004+2023
Frontale doccia TWENTY 1F1S NERA 145	140-145	59-64	2005+2023
Frontale doccia TWENTY 1F1S NERA 150	145-150	61-66	2006+2023
Frontale doccia TWENTY 1F1S NERA 155	150-155	64-69	2007+2024
Frontale doccia TWENTY 1F1S NERA 160	155-160	66-71	2008+2024
Frontale doccia TWENTY 1F1S NERA 165	160-165	69-74	2009+2024
Frontale doccia TWENTY 1F1S NERA 170	165-170	71-76	2010+2024
Frontale doccia TWENTY 1F1S NERA 175	170-175	74-79	2011+2024
Frontale doccia TWENTY 1F1S NERA 180	175-180	76-81	2012+2024

*Composizione per articoli/prezzo a pagina 306

TWENTY NERA 2 fissi+2 scorrevoli

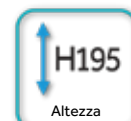

Descrizione	Estensibilità	Apertura	Art.
Frontale doccia TWENTY 2F2S NERA 140 (75+75)	131-141	44-54	2031+2031+2043
Frontale doccia TWENTY 2F2S NERA 150 (80+80)	141-151	49-59	2032+2032+2043
Frontale doccia TWENTY 2F2S NERA 160 (85+85)	151-161	54-64	2033+2033+2043
Frontale doccia TWENTY 2F2S NERA 170 (90+90)	161-171	59-69	2034+2034+2043
Frontale doccia TWENTY 2F2S NERA 180 (95+95)	171-181	64-74	2035+2035+2043
Frontale doccia TWENTY 2F2S NERA 190 (100+100)	181-191	69-79	2036+2036+2043
Opzione maniglia extrapiatta 39,5x1,4x1,6cm			2052N

*Permette laterale fisso in entrambi i lati, vedi pagina 20



	TRASPARENTE	FROST PLUS PARSOL / OPACO
Box doccia su misura e cristalli speciali	+45%	+60%

*Tempo di consegna 3 settimane (maggiori informazioni a pag. 288)

TWENTY NERA apertura angolare



Box doccia su misura e cristalli speciali

TRASPARENTE

+45%

FROST PLUS
PARSOL / OPACO

+60%

*Tempo di consegna 3 settimane (maggiori informazioni a pag. 288)

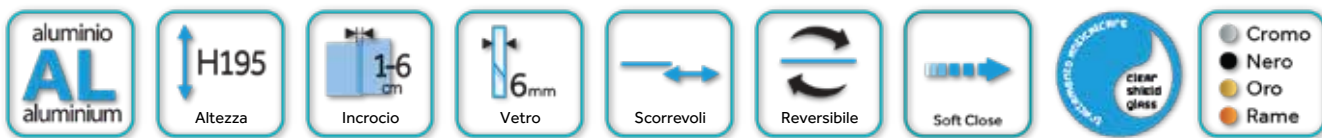

combinazioni **TWENTY NERA** apertura angolare

Cm	Estensibilità	Apertura	Art.
70X70	65-70/65-70	30-35	2030+2030+2039
75X70	70-75/65-70	32-37	2031+2030+2039
80X70	75-80/65-70	34-39	2032+2030+2039
85X70	80-85/65-70	36-41	2033+2030+2039
90X70	85-90/65-70	38-43	2034+2030+2039
95X70	90-95/65-70	40-45	2035+2030+2039
100X70	95-100/65-70	42-47	2036+2030+2039
120X70	115-120/65-70	52-57	2037+2030+2039
Cm	Estensibilità	Apertura	Art.
75X75	70-75/70-75	34-39	2031+2031+2039
80X75	75-80/70-75	36-41	2032+2031+2039
85X75	80-85/70-75	38-43	2033+2031+2039
90X75	85-90/70-75	40-45	2034+2031+2039
95X75	90-95/70-75	42-47	2035+2031+2039
100X75	95-100/70-75	45-50	2036+2031+2039
120X75	115-120/70-75	54-59	2037+2031+2039
Cm	Estensibilità	Apertura	Art.
80X80	75-80/75-80	38-43	2032+2032+2039
85X80	80-85/75-80	40-45	2033+2032+2039
90X80	85-90/75-80	42-47	2034+2032+2039
95X80	90-95/75-80	45-50	2035+2032+2039
100X80	95-100/75-80	47-52	2036+2032+2039
120X80	115-120/75-80	56-61	2037+2032+2039
Cm	Estensibilità	Apertura	Art.
90X90	85-90/85-90	47-52	2034+2034+2039
95X90	90-95/85-90	49-54	2035+2034+2039
100X90	95-100/85-90	50-55	2036+2034+2039
120X90	115-120/85-90	60-65	2037+2034+2039

*Composizione per articoli/prezzo a pagina 306



Innovativo sistema antiribaltamento



Cuscinetto occulto



Apertura soft close



*Set di 2 gomme verticali nere art. 0014

TWENTY NERA frontale + laterale 6mm



Descrizione	Estensibilità	Art.
Laterale fisso TWENTY NERA 70	66,5-69,5	2017
Laterale fisso TWENTY NERA 75	71,5-74,5	2018
Laterale fisso TWENTY NERA 80	76,5-79,5	2019
Laterale fisso TWENTY NERA 90	86,5-89,5	2020



Laterali fissi su misura (maggiori informazioni a pagina 291)

Descrizione	Art.
Laterale fisso su misura TWENTY fino 40 cm	1375N
Laterale fisso su misura TWENTY da 40 fino 80 cm	1376N
Laterale fisso su misura TWENTY da 80 fino 120 cm	1377N

*Tempo di consegna 3 settimane

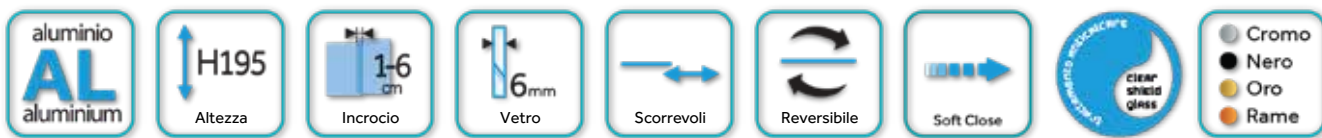

combinazioni frontali **TWENTY NERA** + laterale fisso 6 mm

Cm	Estensibilità	Art.	Cm	Estensibilità	Art.
115x70	110-115/66,5-69,5	1999+2023+2017	115x75	110-115/71,5-74,5	1999+2023+2018
120x70	115-120/66,5-69,5	2000+2023+2017	120x75	115-120/71,5-74,5	2000+2023+2018
125x70	120-125/66,5-69,5	2001+2023+2017	125x75	120-125/71,5-74,5	2001+2023+2018
130x70	125-130/66,5-69,5	2002+2023+2017	130x75	125-130/71,5-74,5	2002+2023+2018
135x70	130-135/66,5-69,5	2003+2023+2017	135x75	130-135/71,5-74,5	2003+2023+2018
140x70	135-140/66,5-69,5	2004+2023+2017	140x75	135-140/71,5-74,5	2004+2023+2018
145x70	140-145/66,5-69,5	2005+2023+2017	145x75	140-145/71,5-74,5	2005+2023+2018
150x70	145-150/66,5-69,5	2006+2023+2017	150x75	145-150/71,5-74,5	2006+2023+2018
155x70	150-155/66,5-69,5	2007+2024+2017	155x75	150-155/71,5-74,5	2007+2024+2018
160x70	155-160/66,5-69,5	2008+2024+2017	160x75	155-160/71,5-74,5	2008+2024+2018
165x70	160-165/66,5-69,5	2009+2024+2017	165x75	160-165/71,5-74,5	2009+2024+2018
170x70	165-170/66,5-69,5	2010+2024+2017	170x75	165-170/71,5-74,5	2010+2024+2018
175x70	170-175/66,5-69,5	2011+2024+2017	175x75	170-175/71,5-74,5	2011+2024+2018
180x70	175-180/66,5-69,5	2012+2024+2017	180x75	175-180/71,5-74,5	2012+2024+2018
Cm	Estensibilità	Art.	Cm	Estensibilità	Art.
115x80	110-115/76,5-79,5	1999+2023+2019	115x90	110-115/86,5-89,5	1999+2023+2020
120x80	115-120/76,5-79,5	2000+2023+2019	120x90	115-120/86,5-89,5	2000+2023+2020
125x80	120-125/76,5-79,5	2001+2023+2019	125x90	120-125/86,5-89,5	2001+2023+2020
130x80	125-130/76,5-79,5	2002+2023+2019	130x90	125-130/86,5-89,5	2002+2023+2020
135x80	130-135/76,5-79,5	2003+2023+2019	135x90	130-135/86,5-89,5	2003+2023+2020
140x80	135-140/76,5-79,5	2004+2023+2019	140x90	135-140/86,5-89,5	2004+2023+2020
145x80	140-145/76,5-79,5	2005+2023+2019	145x90	140-145/86,5-89,5	2005+2023+2020
150x80	145-150/76,5-79,5	2006+2023+2019	150x90	145-150/86,5-89,5	2006+2023+2020
155x80	150-155/76,5-79,5	2007+2024+2019	155x90	150-155/86,5-89,5	2007+2024+2020
160x80	155-160/76,5-79,5	2008+2024+2019	160x90	155-160/86,5-89,5	2008+2024+2020
165x80	160-165/76,5-79,5	2009+2024+2019	165x90	160-165/86,5-89,5	2009+2024+2020
170x80	165-170/76,5-79,5	2010+2024+2019	170x90	165-170/86,5-89,5	2010+2024+2020
175x80	170-175/76,5-79,5	2011+2024+2019	175x90	170-175/86,5-89,5	2011+2024+2020
180x80	175-180/76,5-79,5	2012+2024+2019	180x90	175-180/86,5-89,5	2012+2024+2020

Le aperture sono le stesse dei frontali. Permette laterale fisso in entrambi i lati.



Guida sganciabile



Cuscinetto occulto



Chiusura/apertura soft close



*Set di 2 gomme verticali nere art. 0014

TWENTY ORO 1 fisso+1 scorrevole



Chiusura/apertura soft close



Cuscinetto occulto



Guida sganciabile



Opzione maniglia extrapiatta

Descrizione	Estensibilità	Apertura	Art.
Frontale doccia TWENTY 1F1S ORO 115	110-115	43-48	1999+2044
Frontale doccia TWENTY 1F1S ORO 120	115-120	46-51	2000+2044
Frontale doccia TWENTY 1F1S ORO 125	120-125	49-54	2001+2044
Frontale doccia TWENTY 1F1S ORO 130	125-130	51-56	2002+2044
Frontale doccia TWENTY 1F1S ORO 135	130-135	54-59	2003+2044
Frontale doccia TWENTY 1F1S ORO 140	135-140	56-61	2004+2044
Frontale doccia TWENTY 1F1S ORO 145	140-145	59-64	2005+2044
Frontale doccia TWENTY 1F1S ORO 150	145-150	61-66	2006+2044
Frontale doccia TWENTY 1F1S ORO 155	150-155	64-69	2007+2045
Frontale doccia TWENTY 1F1S ORO 160	155-160	66-71	2008+2045
Frontale doccia TWENTY 1F1S ORO 165	160-165	69-74	2009+2045
Frontale doccia TWENTY 1F1S ORO 170	165-170	71-76	2010+2045
Frontale doccia TWENTY 1F1S ORO 175	170-175	74-79	2011+2045
Frontale doccia TWENTY 1F1S ORO 180	175-180	76-81	2012+2045

*Composizione per articoli/prezzo a pagina 306

TWENTY ORO 2 fissi+2 scorrevoli

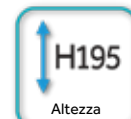

Descrizione	Estensibilità	Apertura	Art.
Frontale doccia TWENTY 2F2S ORO 140 (75+75)	131-141	44-54	2031+2031+2047
Frontale doccia TWENTY 2F2S ORO 150 (80+80)	141-151	49-59	2032+2032+2047
Frontale doccia TWENTY 2F2S ORO 160 (85+85)	151-161	54-64	2033+2033+2047
Frontale doccia TWENTY 2F2S ORO 170 (90+90)	161-171	59-69	2034+2034+2047
Frontale doccia TWENTY 2F2S ORO 180 (95+95)	171-181	64-74	2035+2035+2047
Frontale doccia TWENTY 2F2S ORO 190 (100+100)	181-191	69-79	2036+2036+2047
Opzione maniglia extrapiatta 39,5x1,4x1,6cm			2052OR

*Permette laterale fisso in entrambi i lati, vedi pagina 24.



	TRASPARENTE	FROST PLUS PARSOL / OPACO
Box doccia su misura e cristalli speciali	+45%	+60%

*Tempo di consegna 3 settimane (maggiori informazioni a pag. 288)

TWENTY ORO apertura angolare

Oro spazzolato



Box doccia su misura e cristalli speciali

TRASPARENTE

+45%

FROST PLUS
PARSOL / OPACO

+60%

*Tempo di consegna 3 settimane (maggiori informazioni a pag. 288)

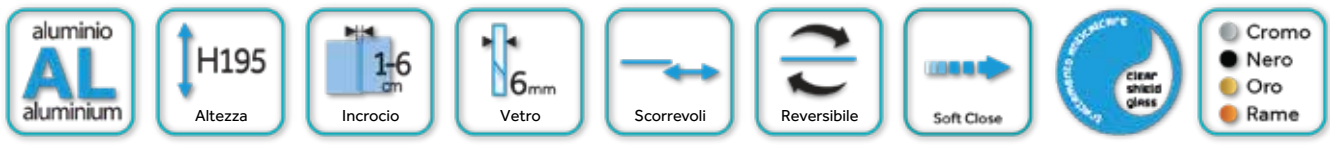

combinazioni **TWENTY ORO** apertura angolare

Cm	Estensibilità	Apertura	Art.
70X70	65-70/65-70	30-35	2030+2030+2046
75X70	70-75/65-70	32-37	2031+2030+2046
80X70	75-80/65-70	34-39	2032+2030+2046
85X70	80-85/65-70	36-41	2033+2030+2046
90X70	85-90/65-70	38-43	2034+2030+2046
95X70	90-95/65-70	40-45	2035+2030+2046
100X70	95-100/65-70	42-47	2036+2030+2046
120X70	115-120/65-70	52-57	2037+2030+2046
Cm	Estensibilità	Apertura	Art.
75X75	70-75/70-75	34-39	2031+2031+2046
80X75	75-80/70-75	36-41	2032+2031+2046
85X75	80-85/70-75	38-43	2033+2031+2046
90X75	85-90/70-75	40-45	2034+2031+2046
95X75	90-95/70-75	42-47	2035+2031+2046
100X75	95-100/70-75	45-50	2036+2031+2046
120X75	115-120/70-75	54-59	2037+2031+2046
Cm	Estensibilità	Apertura	Art.
80X80	75-80/75-80	38-43	2032+2032+2046
85X80	80-85/75-80	40-45	2033+2032+2046
90X80	85-90/75-80	42-47	2034+2032+2046
95X80	90-95/75-80	45-50	2035+2032+2046
100X80	95-100/75-80	47-52	2036+2032+2046
120X80	115-120/75-80	56-61	2037+2032+2046
Cm	Estensibilità	Apertura	Art.
90X90	85-90/85-90	47-52	2034+2034+2046
95X90	90-95/85-90	49-54	2035+2034+2046
100X90	95-100/85-90	50-55	2036+2034+2046
120X90	115-120/85-90	60-65	2037+2034+2046

*Composizione per articoli/prezzo a pagina 306

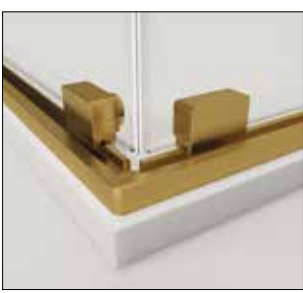

Innovativo sistema antiribaltamento

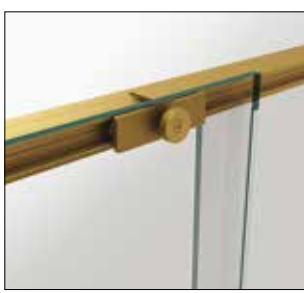

Cuscinetto occulto



Doppia maniglia metallica



Apertura soft close

TWENTY ORO frontale + laterale 6mm

Oro spazzolato



Descrizione	Estensibilità	Art.
Laterale fisso TWENTY ORO 70	66,5-69,5	2048
Laterale fisso TWENTY ORO 75	71,5-74,5	2049
Laterale fisso TWENTY ORO 80	76,5-79,5	2050
Laterale fisso TWENTY ORO 90	86,5-89,5	2051



Laterali fissi su misura (maggiori informazioni a pagina 291)

Descrizione	Art.
Laterale fisso su misura TWENTY fino 40 cm	1375OR
Laterale fisso su misura TWENTY da 40 fino 80 cm	1376OR
Laterale fisso su misura TWENTY da 80 fino 120 cm	1377OR

*Tempo di consegna 3 settimane

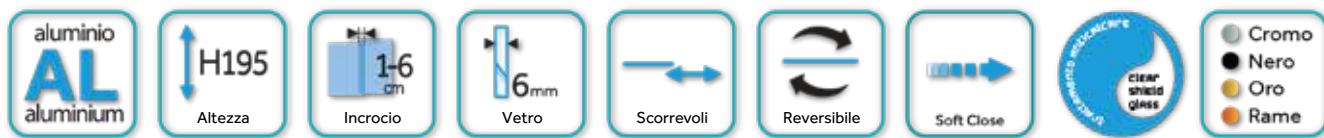

combinazioni frontali **TWENTY ORO** + laterale fisso 6 mm

Cm	Estensibilità	Art.	Cm	Estensibilità	Art.
115x70	110-115/66,5-69,5	1999+2044+2048	115x75	110-115/71,5-74,5	1999+2044+2049
120x70	115-120/66,5-69,5	2000+2044+2048	120x75	115-120/71,5-74,5	2000+2044+2049
125x70	120-125/66,5-69,5	2001+2044+2048	125x75	120-125/71,5-74,5	2001+2044+2049
130x70	125-130/66,5-69,5	2002+2044+2048	130x75	125-130/71,5-74,5	2002+2044+2049
135x70	130-135/66,5-69,5	2003+2044+2048	135x75	130-135/71,5-74,5	2003+2044+2049
140x70	135-140/66,5-69,5	2004+2044+2048	140x75	135-140/71,5-74,5	2004+2044+2049
145x70	140-145/66,5-69,5	2005+2044+2048	145x75	140-145/71,5-74,5	2005+2044+2049
150x70	145-150/66,5-69,5	2006+2044+2048	150x75	145-150/71,5-74,5	2006+2044+2049
155x70	150-155/66,5-69,5	2007+2045+2048	155x75	150-155/71,5-74,5	2007+2045+2049
160x70	155-160/66,5-69,5	2008+2045+2048	160x75	155-160/71,5-74,5	2008+2045+2049
165x70	160-165/66,5-69,5	2009+2045+2048	165x75	160-165/71,5-74,5	2009+2045+2049
170x70	165-170/66,5-69,5	2010+2045+2048	170x75	165-170/71,5-74,5	2010+2045+2049
175x70	170-175/66,5-69,5	2011+2045+2048	175x75	170-175/71,5-74,5	2011+2045+2049
180x70	175-180/66,5-69,5	2012+2045+2048	180x75	175-180/71,5-74,5	2012+2045+2049
Cm	Estensibilità	Art.	Cm	Estensibilità	Art.
115x80	110-115/76,5-79,5	1999+2044+2050	115x90	110-115/86,5-89,5	1999+2044+2051
120x80	115-120/76,5-79,5	2000+2044+2050	120x90	115-120/86,5-89,5	2000+2044+2051
125x80	120-125/76,5-79,5	2001+2044+2050	125x90	120-125/86,5-89,5	2001+2044+2051
130x80	125-130/76,5-79,5	2002+2044+2050	130x90	125-130/86,5-89,5	2002+2044+2051
135x80	130-135/76,5-79,5	2003+2044+2050	135x90	130-135/86,5-89,5	2003+2044+2051
140x80	135-140/76,5-79,5	2004+2044+2050	140x90	135-140/86,5-89,5	2004+2044+2051
145x80	140-145/76,5-79,5	2005+2044+2050	145x90	140-145/86,5-89,5	2005+2044+2051
150x80	145-150/76,5-79,5	2006+2044+2050	150x90	145-150/86,5-89,5	2006+2044+2051
155x80	150-155/76,5-79,5	2007+2045+2050	155x90	150-155/86,5-89,5	2007+2045+2051
160x80	155-160/76,5-79,5	2008+2045+2050	160x90	155-160/86,5-89,5	2008+2045+2051
165x80	160-165/76,5-79,5	2009+2045+2050	165x90	160-165/86,5-89,5	2009+2045+2051
170x80	165-170/76,5-79,5	2010+2045+2050	170x90	165-170/86,5-89,5	2010+2045+2051
175x80	170-175/76,5-79,5	2011+2045+2050	175x90	170-175/86,5-89,5	2011+2045+2051
180x80	175-180/76,5-79,5	2012+2045+2050	180x90	175-180/86,5-89,5	2012+2045+2051

Le aperture sono le stesse dei frontali. Permette laterale fisso in entrambi i lati.



Guida sganciabile



Cuscinetto occulto



Doppia maniglia metallica



Chiusura/apertura soft close

TWENTY RAME 1 fisso+1 scorrevole



Chiusura/apertura soft close



Cuscinetto occulto



Guida sganciabile



Opzione maniglia extrapiatta

Descrizione	Estensibilità	Apertura	Art.
Frontale doccia TWENTY 1F1S RAME 115	110-115	43-48	1999+2060
Frontale doccia TWENTY 1F1S RAME 120	115-120	46-51	2000+2060
Frontale doccia TWENTY 1F1S RAME 125	120-125	49-54	2001+2060
Frontale doccia TWENTY 1F1S RAME 130	125-130	51-56	2002+2060
Frontale doccia TWENTY 1F1S RAME 135	130-135	54-59	2003+2060
Frontale doccia TWENTY 1F1S RAME 140	135-140	56-61	2004+2060
Frontale doccia TWENTY 1F1S RAME 145	140-145	59-64	2005+2060
Frontale doccia TWENTY 1F1S RAME 150	145-150	61-66	2006+2060
Frontale doccia TWENTY 1F1S RAME 155	150-155	64-69	2007+2061
Frontale doccia TWENTY 1F1S RAME 160	155-160	66-71	2008+2061
Frontale doccia TWENTY 1F1S RAME 165	160-165	69-74	2009+2061
Frontale doccia TWENTY 1F1S RAME 170	165-170	71-76	2010+2061
Frontale doccia TWENTY 1F1S RAME 175	170-175	74-79	2011+2061
Frontale doccia TWENTY 1F1S RAME 180	175-180	76-81	2012+2061

*Composizione per articoli/prezzo a pagina 306

TWENTY RAME 2 fissi+2 scorrevoli

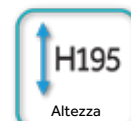

Descrizione	Estensibilità	Apertura	Art.
Frontale doccia TWENTY 2F2S RAME 140 (75+75)	131-141	44-54	2031+2031+2063
Frontale doccia TWENTY 2F2S RAME 150 (80+80)	141-151	49-59	2032+2032+2063
Frontale doccia TWENTY 2F2S RAME 160 (85+85)	151-161	54-64	2033+2033+2063
Frontale doccia TWENTY 2F2S RAME 170 (90+90)	161-171	59-69	2034+2034+2063
Frontale doccia TWENTY 2F2S RAME 180 (95+95)	171-181	64-74	2035+2035+2063
Frontale doccia TWENTY 2F2S RAME 190 (100+100)	181-191	69-79	2036+2036+2063
Opzione maniglia extrapiatta 39,5x1,4x1,6cm			2052CB

*Permette laterale fisso in entrambi i lati, vedi pagina 30.



	TRASPARENTE	FROST PLUS PARSOL / OPACO
Box doccia su misura e cristalli speciali	+45%	+60%

*Tempo di consegna 3 settimane (maggiori informazioni a pag. 288)

TWENTY RAME apertura angolare



Box doccia su misura e cristalli speciali

TRASPARENTE

+45%

FROST PLUS
PARSOL / OPACO

+60%

*Tempo di consegna 3 settimane (maggiori informazioni a pag. 288)

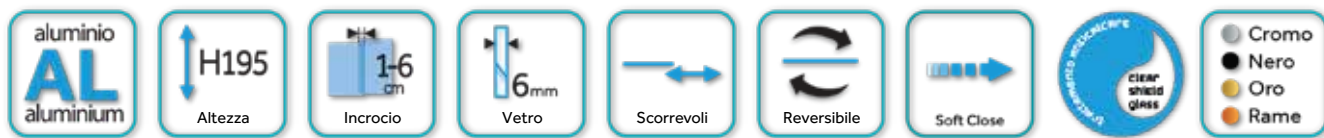

combinazioni **TWENTY RAME** apertura angolare

Cm	Estensibilità	Apertura	Art.
70X70	65-70/65-70	30-35	2030+2030+2062
75X70	70-75/65-70	32-37	2031+2030+2062
80X70	75-80/65-70	34-39	2032+2030+2062
85X70	80-85/65-70	36-41	2033+2030+2062
90X70	85-90/65-70	38-43	2034+2030+2062
95X70	90-95/65-70	40-45	2035+2030+2062
100X70	95-100/65-70	42-47	2036+2030+2062
120X70	115-120/65-70	52-57	2037+2030+2062
Cm	Estensibilità	Apertura	Art.
75X75	70-75/70-75	34-39	2031+2031+2062
80X75	75-80/70-75	36-41	2032+2031+2062
85X75	80-85/70-75	38-43	2033+2031+2062
90X75	85-90/70-75	40-45	2034+2031+2062
95X75	90-95/70-75	42-47	2035+2031+2062
100X75	95-100/70-75	45-50	2036+2031+2062
120X75	115-120/70-75	54-59	2037+2031+2062
Cm	Estensibilità	Apertura	Art.
80X80	75-80/75-80	38-43	2032+2032+2062
85X80	80-85/75-80	40-45	2033+2032+2062
90X80	85-90/75-80	42-47	2034+2032+2062
95X80	90-95/75-80	45-50	2035+2032+2062
100X80	95-100/75-80	47-52	2036+2032+2062
120X80	115-120/75-80	56-61	2037+2032+2062
Cm	Estensibilità	Apertura	Art.
90X90	85-90/85-90	47-52	2034+2034+2062
95X90	90-95/85-90	49-54	2035+2034+2062
100X90	95-100/85-90	50-55	2036+2034+2062
120X90	115-120/85-90	60-65	2037+2034+2062

*Composizione per articoli/prezzo a pagina 306



Innovativo sistema antiribaltamento



Cuscinetto occulto

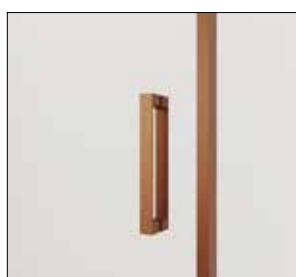

Doppia maniglia metallica



Apertura soft close

TWENTY RAME frontale + laterale 6mm



Descrizione	Estensibilità	Art.
Laterale fisso TWENTY RAME 70	66,5-69,5	2065
Laterale fisso TWENTY RAME 75	71,5-74,5	2066
Laterale fisso TWENTY RAME 80	76,5-79,5	2067
Laterale fisso TWENTY RAME 90	86,5-89,5	2068



Laterali fissi su misura (maggiori informazioni a pagina 291)

Descrizione	Art.
Laterale fisso su misura TWENTY fino 40 cm	1375CB
Laterale fisso su misura TWENTY da 40 fino 80 cm	1376CB
Laterale fisso su misura TWENTY da 80 fino 120 cm	1377CB

*Tempo di consegna 3 settimane

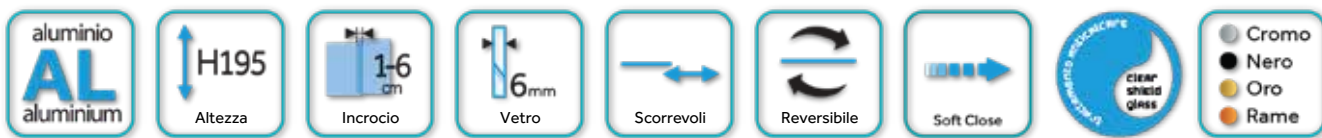

combinazioni frontali **TWENTY RAME** + laterale fisso 6 mm

Cm	Estensibilità	Art.	Cm	Estensibilità	Art.
115x70	110-115/66,5-69,5	1999+2060+2065	115x75	110-115/71,5-74,5	1999+2060+2066
120x70	115-120/66,5-69,5	2000+2060+2065	120x75	115-120/71,5-74,5	2000+2060+2066
125x70	120-125/66,5-69,5	2001+2060+2065	125x75	120-125/71,5-74,5	2001+2060+2066
130x70	125-130/66,5-69,5	2002+2060+2065	130x75	125-130/71,5-74,5	2002+2060+2066
135x70	130-135/66,5-69,5	2003+2060+2065	135x75	130-135/71,5-74,5	2003+2060+2066
140x70	135-140/66,5-69,5	2004+2060+2065	140x75	135-140/71,5-74,5	2004+2060+2066
145x70	140-145/66,5-69,5	2005+2060+2065	145x75	140-145/71,5-74,5	2005+2060+2066
150x70	145-150/66,5-69,5	2006+2060+2065	150x75	145-150/71,5-74,5	2006+2060+2066
155x70	150-155/66,5-69,5	2007+2061+2065	155x75	150-155/71,5-74,5	2007+2061+2066
160x70	155-160/66,5-69,5	2008+2061+2065	160x75	155-160/71,5-74,5	2008+2061+2066
165x70	160-165/66,5-69,5	2009+2061+2065	165x75	160-165/71,5-74,5	2009+2061+2066
170x70	165-170/66,5-69,5	2010+2061+2065	170x75	165-170/71,5-74,5	2010+2061+2066
175x70	170-175/66,5-69,5	2011+2061+2065	175x75	170-175/71,5-74,5	2011+2061+2066
180x70	175-180/66,5-69,5	2012+2061+2065	180x75	175-180/71,5-74,5	2012+2061+2066
Cm	Estensibilità	Art.	Cm	Estensibilità	Art.
115x80	110-115/76,5-79,5	1999+2060+2067	115x90	110-115/86,5-89,5	1999+2060+2068
120x80	115-120/76,5-79,5	2000+2060+2067	120x90	115-120/86,5-89,5	2000+2060+2068
125x80	120-125/76,5-79,5	2001+2060+2067	125x90	120-125/86,5-89,5	2001+2060+2068
130x80	125-130/76,5-79,5	2002+2060+2067	130x90	125-130/86,5-89,5	2002+2060+2068
135x80	130-135/76,5-79,5	2003+2060+2067	135x90	130-135/86,5-89,5	2003+2060+2068
140x80	135-140/76,5-79,5	2004+2060+2067	140x90	135-140/86,5-89,5	2004+2060+2068
145x80	140-145/76,5-79,5	2005+2060+2067	145x90	140-145/86,5-89,5	2005+2060+2068
150x80	145-150/76,5-79,5	2006+2060+2067	150x90	145-150/86,5-89,5	2006+2060+2068
155x80	150-155/76,5-79,5	2007+2061+2067	155x90	150-155/86,5-89,5	2007+2061+2068
160x80	155-160/76,5-79,5	2008+2061+2067	160x90	155-160/86,5-89,5	2008+2061+2068
165x80	160-165/76,5-79,5	2009+2061+2067	165x90	160-165/86,5-89,5	2009+2061+2068
170x80	165-170/76,5-79,5	2010+2061+2067	170x90	165-170/86,5-89,5	2010+2061+2068
175x80	170-175/76,5-79,5	2011+2061+2067	175x90	170-175/86,5-89,5	2011+2061+2068
180x80	175-180/76,5-79,5	2012+2061+2067	180x90	175-180/86,5-89,5	2012+2061+2068

Le aperture sono le stesse dei frontali. Permette laterale fisso in entrambi i lati.



Guida sganciabile



Cuscinetto occulto

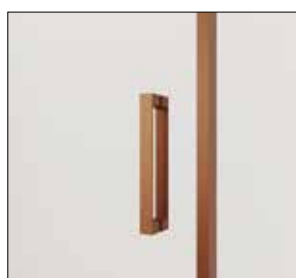

Doppia maniglia metallica



Chiusura/apertura soft close

kenna

8mm

“Design all'avanguardia con
assenza di profili con porta
scorrevole interna”

● 34-41 CROMO

● 42-49 NERO

● 50-57 ORO





KENNA 1 fisso + 1 scorrevole



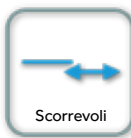

Frontali KENNA 1 fisso + 1 scorrevole

Descrizione	Estensibilità	Apertura	Art.
Frontale doccia KENNA 1F1S 100	95-100	34-39	6530CR
Frontale doccia KENNA 1F1S 105	100-105	37-42	6531CR
Frontale doccia KENNA 1F1S 110	105-110	39-44	6532CR
Frontale doccia KENNA 1F1S 115	110-115	42-47	6533CR
Frontale doccia KENNA 1F1S 120	115-120	44-49	6534CR
Frontale doccia KENNA 1F1S 125	120-125	47-52	6535CR
Frontale doccia KENNA 1F1S 130	125-130	49-54	6536CR
Frontale doccia KENNA 1F1S 135	130-135	52-57	6537CR
Frontale doccia KENNA 1F1S 140	135-140	52-57	6538CR
Frontale doccia KENNA 1F1S 145	140-145	57-62	6539CR
Frontale doccia KENNA 1F1S 150	145-150	57-62	6540CR
Frontale doccia KENNA 1F1S 155	150-155	62-67	6541CR
Frontale doccia KENNA 1F1S 160	155-160	64-69	6542CR
Frontale doccia KENNA 1F1S 165	160-165	64-69	6543CR
Frontale doccia KENNA 1F1S 170	165-170	64-69	6544CR
Frontale doccia KENNA 1F1S 175	170-175	64-69	6545CR
Frontale doccia KENNA 1F1S 180	175-180	64-69	6546CR

Composizione per articoli/prezzo a pagina 307



Barra orientabile



Doppia maniglia metallica



Cuscinetto interno anta



Opzione maniglia
Extrapiatta 22x1,6x0,7cm
Art. 1731



Opzione maniglia
Lunga 40x1,2x1,5cm
Art. 1732



Opzione barra parallela 200 cm, art. 5546



Nel formato Free l'estensibilità si riduce di 2 cm

KENNA 2 fissi + 2 scorrevoli



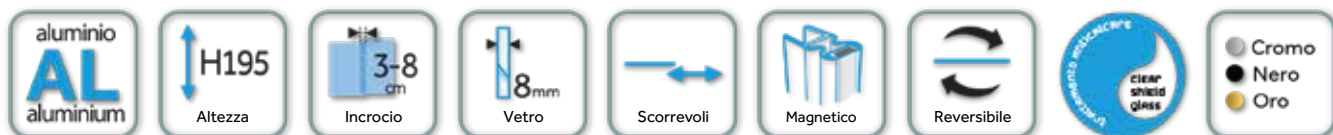

Frontali KENNA 2 fissi + 2 scorrevoli

Descrizione	Estensibilità	Apertura	Art.
Frontale doccia KENNA 2F2S 140 (75+75)	131-141	41-51	KNSP140
Frontale doccia KENNA 2F2S 150 (80+80)	141-151	46-56	KNSP150
Frontale doccia KENNA 2F2S 160 (85+85)	151-161	51-61	KNSP160
Frontale doccia KENNA 2F2S 170 (90+90)	161-171	46-66	KNSP170
Frontale doccia KENNA 2F2S 180 (95+95)	171-181	61-71	KNSP180
Frontale doccia KENNA 2F2S 190 (100+100)	181-191	66-76	KNSP190
Frontale doccia KENNA 2F2S 200 (105+105)	196-206	75-85	KNSP200
Frontale doccia KENNA 2F2S 210 (110+110)	206-216	80-90	KNSP210
Frontale doccia KENNA 2F2S 220 (115+115)	216-226	85-95	KNSP220
Frontale doccia KENNA 2F2S 230 (120+120)	221-231	90-100	KNSP230

*Estensibilità calcolata senza espansione del profilo +1,5 cm, per lato

Frontali KENNA XXL 2 fissi + 2 scorrevoli

Descrizione	Estensibilità	Apertura	Art.
Frontale doccia KENNA 2F2S 240 (125+125)	234-244	95-105	KNSP240
Frontale doccia KENNA 2F2S 250 (130+130)	244-254	100-110	KNSP250
Frontale doccia KENNA 2F2S 260 (135+135)	254-264	105-115	KNSP260
Frontale doccia KENNA 2F2S 270 (140+140)	264-274	105-115	KNSP270
Frontale doccia KENNA 2F2S 280 (145+145)	274-284	115-125	KNSP280
Frontale doccia KENNA 2F2S 290 (150+150)	284-294	115-125	KNSP290
Frontale doccia KENNA 2F2S 300 (155+155)	294-304	125-135	KNSP300
Frontale doccia KENNA 2F2S 310 (160+160)	304-314	130-140	KNSP310

*Estensibilità calcolata senza espansione del profilo +1,5 cm, per lato



Barra orientabile



Doppia maniglia metallica



Cuscinetto interno anta



Opzione maniglia
Extrapiatta
22x1,6x0,7cm
Art. 1731



Opzione maniglia
Lunga 40x1,2x1,5cm
Art. 1732

KENNA apertura angolare



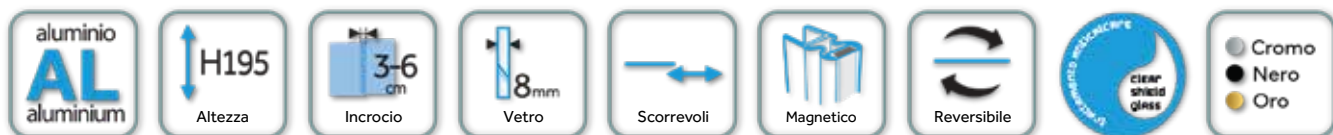

Combinazioni KENNA apertura angolare

Cm	Estensibilità	Apertura	Art.
70x70	65-70/65-70	32-35	KNAV7070
75x70	70-75/65-70	34-37	KNAV7570
80x70	75-80/65-70	36-39	KNAV8070
85x70	80-85/65-70	38-41	KNAV8570
90x70	85-90/65-70	40-43	KNAV9070
95x70	85-95/65-70	42-45	KNAV9570
100x70	95-100/65-70	44-47	KNAV10070
120x70	115-120/65-70	48-51	KNAV12070
75x75	70-75/70-75	36-39	KNAV7575
80x75	75-80/70-75	38-41	KNAV8075
85x75	80-85/70-75	40-43	KNAV8575
90x75	85-90/70-75	42-45	KNAV9075
95x75	85-95/70-75	44-47	KNAV9575
100x75	95-100/70-75	46-49	KNAV10075
120x75	115-120/70-75	50-53	KNAV12075
80x80	75-80/75-80	39-42	KNAV8080
85x80	80-85/75-80	41-44	KNAV8580
90x80	85-90/75-80	43-46	KNAV9080
95x80	85-95/75-80	45-48	KNAV9580
100x80	95-100/75-80	47-50	KNAV10080
120x80	115-120/75-80	51-54	KNAV12080
90x90	85-90/85-90	46-49	KNAV9090
95x90	85-95/85-90	48-51	KNAV9590
100x90	95-100/85-90	50-53	KNAV10090
120x90	115-120/85-90	54-57	KNAV12090
100x100	95-100/95-100	54-57	KNAV100100
120x100	115-120/95-100	58-61	KNAV120100
120x120	115-120/115-120	67-70	KNAV120120

*La dimensione massima si ottiene allargando il profilo (+1,5 cm).

*Composizione per articoli/prezzo a pagina 307



Barra orientabile



Doppia maniglia metallica



Cuscinetto interno anta



Opzione maniglia
Extrapiatta
22x1,6x0,7cm
Art. 1731



Opzione maniglia
Lunga 40x1,2x1,5cm
Art. 1732

KENNA frontale + laterale fisso 8 mm



Descrizione	Estensibilità	Art.
Laterale fisso KENNA 70	67-69	6547CR
Laterale fisso KENNA 75	72-74	6548CR
Laterale fisso KENNA 80	77-79	6549CR
Laterale fisso KENNA 90	87-89	6550CR

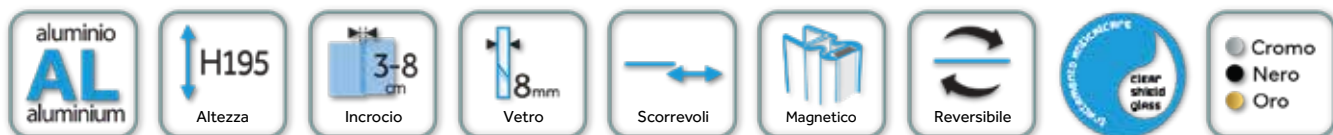

Combinazioni frontali KENNA + laterale fisso 8 mm

Cm	Estensibilità	Art.	Cm	Estensibilità	Art.
100x70	95-100/67-69	KNAF10070	100x75	95-100/72-74	KNAF10075
110x70	105-110/67-69	KNAF11070	110x75	105-110/72-74	KNAF11075
120x70	115-120/67-69	KNAF12070	120x75	115-120/72-74	KNAF12075
130x70	125-130/67-69	KNAF13070	130x75	125-130/72-74	KNAF13075
140x70	135-140/67-69	KNAF14070	140x75	135-140/72-74	KNAF14075
150x70	145-150/67-69	KNAF15070	150x75	145-150/72-74	KNAF15075
160x70	155-160/67-69	KNAF16070	160x75	155-160/72-74	KNAF16075
170x70	165-170/67-69	KNAF17070	170x75	165-170/72-74	KNAF17075
180x70	175-180/67-69	KNAF18070	180x75	175-180/72-74	KNAF18075
Cm	Estensibilità	Art.	Cm	Estensibilità	Art.
100x80	95-100/77-79	KNAF10080	100x90	95-100/87-89	KNAF10090
110x80	105-110/77-79	KNAF11080	110x90	105-110/87-89	KNAF11090
120x80	115-120/77-79	KNAF12080	120x90	115-120/87-89	KNAF12090
130x80	125-130/77-79	KNAF13080	130x90	125-130/87-89	KNAF13090
140x80	135-140/77-79	KNAF14080	140x90	135-140/87-89	KNAF14090
150x80	145-150/77-79	KNAF15080	150x90	145-150/87-89	KNAF15090
160x80	155-160/77-79	KNAF16080	160x90	155-160/87-89	KNAF16090
170x80	165-170/77-79	KNAF17080	170x90	165-170/87-89	KNAF17090
180x80	175-180/77-79	KNAF18080	180x90	175-180/87-89	KNAF18090

Si possono fare combinazioni con misure intermedie dei frontali fino 175 cm. La apertura +2 cm del frontale.



Opzione barra parallela 200 cm, art. 5546



Opzione maniglia
Extrapiatta 22x1,6x0,7cm
Art. 1731



Opzione maniglia
Lunga 40x1,2x1,5cm
Art. 1732



Laterali fissi su misura (maggiori informazioni a pagina 291)

Descrizione	Art.
misura fino 40 cm	1365
misura da 40 fino 80 cm	1366
misura da 80 fino 120 cm	1367

*Tempo di consegna 3 settimane

KENNA NERA 1 fisso + 1 scorrevole



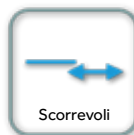

Frontali KENNA NERA 1 fisso + 1 scorrevole

Descrizione	Estensibilità	Apertura	Art.
Frontale doccia KENNA 1F1S NERA 100	95-100	34-39	6530N
Frontale doccia KENNA 1F1S NERA 105	100-105	37-42	6531N
Frontale doccia KENNA 1F1S NERA 110	105-110	39-44	6532N
Frontale doccia KENNA 1F1S NERA 115	110-115	42-47	6533N
Frontale doccia KENNA 1F1S NERA 120	115-120	44-49	6534N
Frontale doccia KENNA 1F1S NERA 125	120-125	47-52	6535N
Frontale doccia KENNA 1F1S NERA 130	125-130	49-54	6536N
Frontale doccia KENNA 1F1S NERA 135	130-135	52-57	6537N
Frontale doccia KENNA 1F1S NERA 140	135-140	52-57	6538N
Frontale doccia KENNA 1F1S NERA 145	140-145	57-62	6539N
Frontale doccia KENNA 1F1S NERA 150	145-150	57-62	6540N
Frontale doccia KENNA 1F1S NERA 155	150-155	62-67	6541N
Frontale doccia KENNA 1F1S NERA 160	155-160	64-69	6542N
Frontale doccia KENNA 1F1S NERA 165	160-165	64-69	6543N
Frontale doccia KENNA 1F1S NERA 170	165-170	64-69	6544N
Frontale doccia KENNA 1F1S NERA 175	170-175	64-69	6545N
Frontale doccia KENNA 1F1S NERA 180	175-180	64-69	6546N

Composizione per articoli/prezzo a pagina 307



Barra orientabile



Doppia maniglia metallica



Cuscinetto interno anta



Opzione maniglia
Extrapiatta 22x1,6x0,7cm
Art. 9031



Opzione maniglia
Lunga 40x1,2x1,5cm
Art. 1732N



Opzione barra parallela 200 cm, art. 5546N



Nel formato Free l'estensibilità si riduce di 2 cm

KENNA NERA 2 fissi + 2 scorrevoli



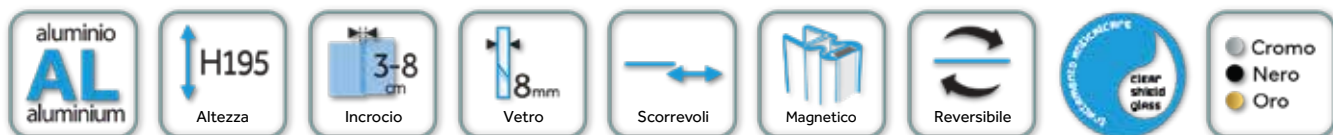

Frontali KENNA NERA 2 fissi + 2 scorrevoli

Descrizione	Estensibilità	Apertura	Art.
Frontale doccia KENNA NERA 2F2S 140 (75+75)	131-141	41-51	KNSP140N
Frontale doccia KENNA NERA 2F2S 150 (80+80)	141-151	46-56	KNSP150N
Frontale doccia KENNA NERA 2F2S 160 (85+85)	151-161	51-61	KNSP160N
Frontale doccia KENNA NERA 2F2S 170 (90+90)	161-171	46-66	KNSP170N
Frontale doccia KENNA NERA 2F2S 180 (95+95)	171-181	61-71	KNSP180N
Frontale doccia KENNA NERA 2F2S 190 (100+100)	181-191	66-76	KNSP190N
Frontale doccia KENNA NERA 2F2S 200 (105+105)	196-206	75-85	KNSP200N
Frontale doccia KENNA NERA 2F2S 210 (110+110)	206-216	80-90	KNSP210N
Frontale doccia KENNA NERA 2F2S 220 (115+115)	216-226	85-95	KNSP220N
Frontale doccia KENNA NERA 2F2S 230 (120+120)	221-231	90-100	KNSP230N

*Estensibilità calcolata senza espansione del profilo +1,5 cm, per lato

Frontali KENNA NERA XXL 2 fissi + 2 scorrevoli

Descrizione	Estensibilità	Apertura	Art.
Frontale doccia KENNA NERA 2F2S 240 (125+125)	234-244	95-105	KNSP240N
Frontale doccia KENNA NERA 2F2S 250 (130+130)	244-254	100-110	KNSP250N
Frontale doccia KENNA NERA 2F2S 260 (135+135)	254-264	105-115	KNSP260N
Frontale doccia KENNA NERA 2F2S 270 (140+140)	264-274	105-115	KNSP270N
Frontale doccia KENNA NERA 2F2S 280 (145+145)	274-284	115-125	KNSP280N
Frontale doccia KENNA NERA 2F2S 290 (150+150)	284-294	115-125	KNSP290N
Frontale doccia KENNA NERA 2F2S 300 (155+155)	294-304	125-135	KNSP300N
Frontale doccia KENNA NERA 2F2S 310 (160+160)	304-314	130-140	KNSP310N

*Estensibilità calcolata senza espansione del profilo +1,5 cm, per lato



Barra orientabile



Doppia maniglia metallica



Cuscinetto interno anta



Opzione maniglia
Extraplatina
22x1,6x0,7cm
Art. 9031



Opzione maniglia
Lunga 40x1,2x1,5cm
Art. 1732N

KENNA NERA apertura angolare



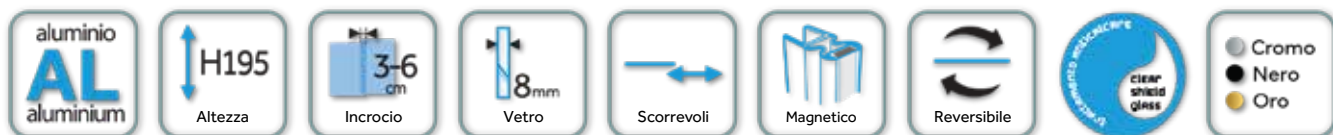

Combinazioni KENNA NERA apertura angolare

Cm	Estensibilità	Apertura	Art.
70x70	65-70/65-70	30-33	KNAV7070N
75x70	70-75/65-70	34-37	KNAV7570N
80x70	75-80/65-70	36-39	KNAV8070N
85x70	80-85/65-70	38-41	KNAV8570N
90x70	85-90/65-70	40-43	KNAV9070N
95x70	85-95/65-70	42-45	KNAV9570N
100x70	95-100/65-70	44-47	KNAV10070N
120x70	115-120/65-70	48-51	KNAV12070N
75x75	70-75/70-75	36-39	KNAV7575N
80x75	75-80/70-75	38-41	KNAV8075N
85x75	80-85/70-75	40-43	KNAV8575N
90x75	85-90/70-75	42-45	KNAV9075N
95x75	85-95/70-75	44-47	KNAV9575N
100x75	95-100/70-75	46-49	KNAV10075N
120x75	115-120/70-75	50-53	KNAV12075N
80x80	75-80/75-80	37-40	KNAV8080N
85x80	80-85/75-80	41-44	KNAV8580N
90x80	85-90/75-80	43-46	KNAV9080N
95x80	85-95/75-80	45-48	KNAV9580N
100x80	95-100/75-80	47-50	KNAV10080N
120x80	115-120/75-80	51-54	KNAV12080N
90x90	85-90/85-90	44-47	KNAV9090N
95x90	85-95/85-90	48-51	KNAV9590N
100x90	95-100/85-90	50-53	KNAV10090N
120x90	115-120/85-90	54-57	KNAV12090N
100x100	95-100/ 95-100	54-57	KNAV100100N
120x100	115-120/95-100	58-61	KNAV120100N
120x120	115-120/115-120	67-70	KNAV120120N

*La dimensione massima si ottiene allargando il profilo (+1,5 cm).

*Composizione per articoli/prezzo a pagina 307



Barra orientabile



Doppia maniglia metallica



Cuscinetto interno anta



Opzione maniglia
Extrapiatta
22x1,6x0,7cm
Art. 9031



Opzione maniglia
Lunga 40x1,2x1,5cm
Art. 1732N

KENNA NERA frontale + laterale fisso 8 mm



Opzione barra parallela 200 cm, art. 5546N

Descrizione	Estensibilità	Art.
Laterale fisso KENNA 70	67-69	6547N
Laterale fisso KENNA 75	72-74	6548N
Laterale fisso KENNA 80	77-79	6549N
Laterale fisso KENNA 90	87-89	6550N

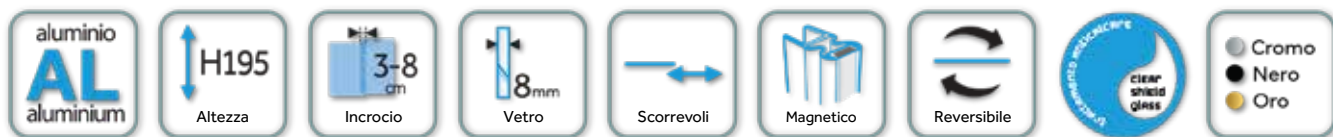

Combinazioni frontali KENNA NERA + laterale fisso 8 mm

Cm	Estensibilità	Art.	Cm	Estensibilità	Art.
100x70	95-100/67-69	KNAF10070N	100x75	95-100/72-74	KNAF10075N
110x70	105-110/67-69	KNAF11070N	110x75	105-110/72-74	KNAF11075N
120x70	115-120/67-69	KNAF12070N	120x75	115-120/72-74	KNAF12075N
130x70	125-130/67-69	KNAF13070N	130x75	125-130/72-74	KNAF13075N
140x70	135-140/67-69	KNAF14070N	140x75	135-140/72-74	KNAF14075N
150x70	145-150/67-69	KNAF15070N	150x75	145-150/72-74	KNAF15075N
160x70	155-160/67-69	KNAF16070N	160x75	155-160/72-74	KNAF16075N
170x70	165-170/67-69	KNAF17070N	170x75	165-170/72-74	KNAF17075N
180x70	175-180/67-69	KNAF18070N	180x75	175-180/72-74	KNAF18075N
Cm	Estensibilità	Art.	Cm	Estensibilità	Art.
100x80	95-100/77-79	KNAF10080N	100x90	95-100/87-89	KNAF10090N
110x80	105-110/77-79	KNAF11080N	110x90	105-110/87-89	KNAF11090N
120x80	115-120/77-79	KNAF12080N	120x90	115-120/87-89	KNAF12090N
130x80	125-130/77-79	KNAF13080N	130x90	125-130/87-89	KNAF13090N
140x80	135-140/77-79	KNAF14080N	140x90	135-140/87-89	KNAF14090N
150x80	145-150/77-79	KNAF15080N	150x90	145-150/87-89	KNAF15090N
160x80	155-160/77-79	KNAF16080N	160x90	155-160/87-89	KNAF16090N
170x80	165-170/77-79	KNAF17080N	170x90	165-170/87-89	KNAF17090N
180x80	175-180/77-79	KNAF18080N	180x90	175-180/87-89	KNAF18090N

Si possono fare combinazioni con misure intermedie dei frontali fino 175 cm. La apertura +2 cm del frontale.



Opzione barra parallela 200 cm, art. 5546N



Opzione maniglia
Extraplatte
22x1,6x0,7cm
Art. 9031



Opzione maniglia
Lunga 40x1,2x1,5cm
Art. 1732N



Laterali fissi su misura (maggiori informazioni a pagina 291)

Descrizione	Art.
misura fino 40 cm	1365N
misura da 40 fino 80 cm	1366N
misura da 80 fino 120 cm	1367N

*Tempo di consegna 3 settimane

KENNA ORO 1 fisso + 1 scorrevole



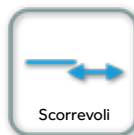

Frontali KENNA ORO 1 fisso + 1 scorrevole

Descrizione	Estensibilità	Apertura	Art.
Frontale doccia KENNA 1F1S ORO 100	95-100	34-39	6530OR
Frontale doccia KENNA 1F1S ORO 105	100-105	37-42	6531OR
Frontale doccia KENNA 1F1S ORO 110	105-110	39-44	6532OR
Frontale doccia KENNA 1F1S ORO 115	110-115	42-47	6533OR
Frontale doccia KENNA 1F1S ORO 120	115-120	44-49	6534OR
Frontale doccia KENNA 1F1S ORO 125	120-125	47-52	6535OR
Frontale doccia KENNA 1F1S ORO 130	125-130	49-54	6536OR
Frontale doccia KENNA 1F1S ORO 135	130-135	52-57	6537OR
Frontale doccia KENNA 1F1S ORO 140	135-140	52-57	6538OR
Frontale doccia KENNA 1F1S ORO 145	140-145	57-62	6539OR
Frontale doccia KENNA 1F1S ORO 150	145-150	57-62	6540OR
Frontale doccia KENNA 1F1S ORO 155	150-155	62-67	6541OR
Frontale doccia KENNA 1F1S ORO 160	155-160	64-69	6542OR
Frontale doccia KENNA 1F1S ORO 165	160-165	64-69	6543OR
Frontale doccia KENNA 1F1S ORO 170	165-170	64-69	6544OR
Frontale doccia KENNA 1F1S ORO 175	170-175	64-69	6545OR
Frontale doccia KENNA 1F1S ORO 180	175-180	64-69	6546OR

Composizione per articoli/prezzo a pagina 307



Barra orientabile



Doppia maniglia metallica



Cuscinetto interno anta



Opzione maniglia
Extrapiatta 22x1,6x0,7cm
R. 1731OR



Opzione maniglia
Lunga 40x1,2x1,5cm
R. 1732OR



Opzione barra parallela 200 cm art. 5546OR



Nel formato Free l'estensibilità si riduce di 2 cm

KENNA ORO 2 fissi + 2 scorrevoli



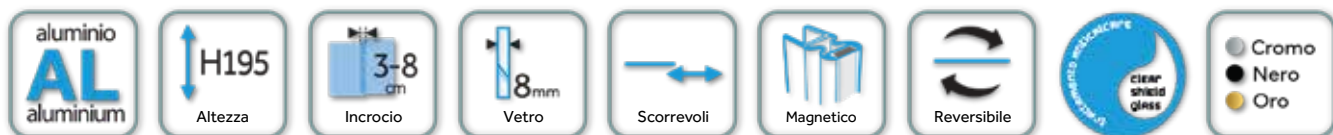

Frontali KENNA ORO 2 fissi + 2 scorrevoli

Descrizione	Estensibilità	Apertura	Art.
Frontale doccia KENNA ORO 2F2S 140 (75+75)	131-141	41-51	KNSP140OR
Frontale doccia KENNA ORO 2F2S 150 (80+80)	141-151	46-56	KNSP150OR
Frontale doccia KENNA ORO 2F2S 160 (85+85)	151-161	51-61	KNSP160OR
Frontale doccia KENNA ORO 2F2S 170 (90+90)	161-171	46-66	KNSP170OR
Frontale doccia KENNA ORO 2F2S 180 (95+95)	171-181	61-71	KNSP180OR
Frontale doccia KENNA ORO 2F2S 190 (100+100)	181-191	66-76	KNSP190OR
Frontale doccia KENNA ORO 2F2S 200 (105+105)	196-206	75-85	KNSP200OR
Frontale doccia KENNA ORO 2F2S 210 (110+110)	206-216	80-90	KNSP210OR
Frontale doccia KENNA ORO 2F2S 220 (115+115)	216-226	85-95	KNSP220OR
Frontale doccia KENNA ORO 2F2S 230 (120+120)	221-231	90-100	KNSP230OR

*Estensibilità calcolata senza espansione del profilo +1,5 cm, per lato

Frontali KENNA ORO XXL 2 fissi + 2 scorrevoli

Descrizione	Estensibilità	Apertura	Art.
Frontale doccia KENNA ORO 2F2S 240 (125+125)	234-244	95-105	KNSP240OR
Frontale doccia KENNA ORO 2F2S 250 (130+130)	244-254	100-110	KNSP250OR
Frontale doccia KENNA ORO 2F2S 260 (135+135)	254-264	105-115	KNSP260OR
Frontale doccia KENNA ORO 2F2S 270 (140+140)	264-274	105-115	KNSP270OR
Frontale doccia KENNA ORO 2F2S 280 (145+145)	274-284	115-125	KNSP280OR
Frontale doccia KENNA ORO 2F2S 290 (150+150)	284-294	115-125	KNSP290OR
Frontale doccia KENNA ORO 2F2S 300 (155+155)	294-304	125-135	KNSP300OR
Frontale doccia KENNA ORO 2F2S 310 (160+160)	304-314	130-140	KNSP310OR

*Estensibilità calcolata senza espansione del profilo +1,5 cm, per lato



Barra orientabile



Doppia maniglia metallica



Cuscinetto interno anta



Opzione maniglia
Extrapiatta
22x1,6x0,7cm
R. 1731OR



Opzione maniglia
Lunga 40x1,2x1,5cm
R. 1732OR

KENNA ORO apertura angolare



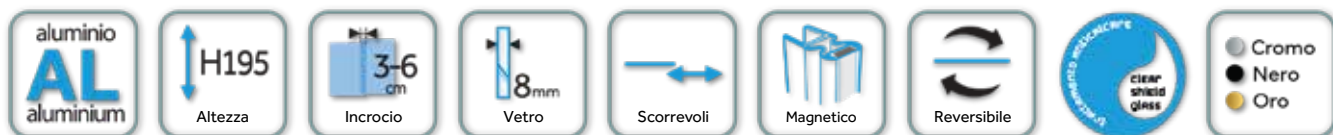

Combinazioni KENNA ORO apertura angolare

Cm	Estensibilità	Apertura	Art.
70x70	65-70/65-70	32-35	KNAV7070OR
75x70	70-75/65-70	34-37	KNAV7570OR
80x70	75-80/65-70	36-39	KNAV8070OR
85x70	80-85/65-70	38-41	KNAV8570OR
90x70	85-90/65-70	40-43	KNAV9070OR
95x70	85-95/65-70	42-45	KNAV9570OR
100x70	95-100/65-70	44-47	KNAV10070OR
120x70	115-120/65-70	48-51	KNAV12070OR
75x75	70-75/70-75	36-39	KNAV7575OR
80x75	75-80/70-75	38-41	KNAV8075OR
85x75	80-85/70-75	40-43	KNAV8575OR
90x75	85-90/70-75	42-45	KNAV9075OR
95x75	85-95/70-75	44-47	KNAV9575OR
100x75	95-100/70-75	46-49	KNAV10075OR
120x75	115-120/70-75	50-53	KNAV12075OR
80x80	75-80/75-80	39-42	KNAV8080OR
85x80	80-85/75-80	41-44	KNAV8580OR
90x80	85-90/75-80	43-46	KNAV9080OR
95x80	85-95/75-80	45-48	KNAV9580OR
100x80	95-100/75-80	47-50	KNAV10080OR
120x80	115-120/75-80	51-54	KNAV12080OR
90x90	85-90/85-90	46-49	KNAV9090OR
95x90	85-95/85-90	48-51	KNAV9590OR
100x90	95-100/85-90	50-53	KNAV10090OR
120x90	115-120/85-90	54-57	KNAV12090OR
100x100	95-100/95-100	54-57	KNAV100100OR
120x100	115-120/95-100	58-61	KNAV120100OR
120x120	115-120/115-120	67-70	KNAV120120OR

*La dimensione massima si ottiene allargando il profilo (+1,5 cm).

*Composizione per articoli/prezzo a pagina 307



Barra orientabile



Doppia maniglia metallica



Cuscinetto interno anta



Opzione maniglia
Extrapiatte
22x1,6x0,7cm
R. 1731OR



Opzione maniglia
Lunga 40x1,2x1,5cm
R. 1732OR

KENNA ORO frontale + laterale fisso 8 mm



Descrizione	Estensibilità	Art.
Laterale fisso KENNA 70	67-69	6547OR
Laterale fisso KENNA 75	72-74	6548OR
Laterale fisso KENNA 80	77-79	6549OR
Laterale fisso KENNA 90	87-89	6550OR

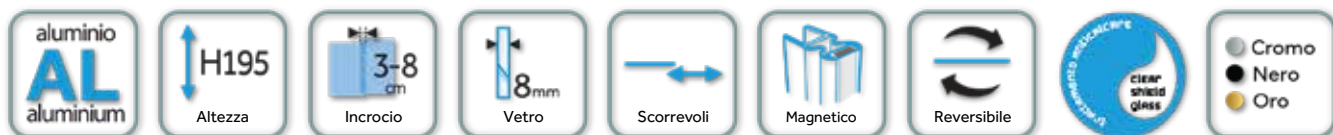

Combinazioni frontali KENNA ORO + laterale fisso 8 mm

Cm	Estensibilità	Art.	Cm	Estensibilità	Art.
100x70	95-100/67-69	KNAF10070OR	100x75	95-100/72-74	KNAF10075OR
110x70	105-110/67-69	KNAF11070OR	110x75	105-110/72-74	KNAF11075OR
120x70	115-120/67-69	KNAF12070OR	120x75	115-120/72-74	KNAF12075OR
130x70	125-130/67-69	KNAF13070OR	130x75	125-130/72-74	KNAF13075OR
140x70	135-140/67-69	KNAF14070OR	140x75	135-140/72-74	KNAF14075OR
150x70	145-150/67-69	KNAF15070OR	150x75	145-150/72-74	KNAF15075OR
160x70	155-160/67-69	KNAF16070OR	160x75	155-160/72-74	KNAF16075OR
170x70	165-170/67-69	KNAF17070OR	170x75	165-170/72-74	KNAF17075OR
180x70	175-180/67-69	KNAF18070OR	180x75	175-180/72-74	KNAF18075OR
Cm	Estensibilità	Art.	Cm	Estensibilità	Art.
100x80	95-100/77-79	KNAF10080OR	100x90	95-100/87-89	KNAF10090OR
110x80	105-110/77-79	KNAF11080OR	110x90	105-110/87-89	KNAF11090OR
120x80	115-120/77-79	KNAF12080OR	120x90	115-120/87-89	KNAF12090OR
130x80	125-130/77-79	KNAF13080OR	130x90	125-130/87-89	KNAF13090OR
140x80	135-140/77-79	KNAF14080OR	140x90	135-140/87-89	KNAF14090OR
150x80	145-150/77-79	KNAF15080OR	150x90	145-150/87-89	KNAF15090OR
160x80	155-160/77-79	KNAF16080OR	160x90	155-160/87-89	KNAF16090OR
170x80	165-170/77-79	KNAF17080OR	170x90	165-170/87-89	KNAF17090OR
180x80	175-180/77-79	KNAF18080OR	180x90	175-180/87-89	KNAF18090OR

Si possono fare combinazioni con misure intermedie dei frontali fino 175 cm. La apertura +2 cm del frontale.



Opzione barra parallela 200 cm art. 5546OR



Opzione maniglia Extrapiatta
22x1,6x0,7cm
R. 1731OR



Opzione maniglia Lunga 40x1,2x1,5cm
R. 1732OR









Laterali fissi su misura (maggiori informazioni a pagina 291)

Descrizione	Art.
misura fino 40 cm	1365OR
misura da 40 fino 80 cm	1366OR
misura da 80 fino 120 cm	1367OR

*Tempo di consegna 3 settimane

basic

“Un rapporto qualità-prezzo
imbattibile e un’ampia
gamma di formati,
dimensioni e colori”

	CROMO	60-67
	NERO	68
	BIANCO	68
	ORO	70
	NICHEL	70
	RAME	72
	TITANIO	72





BASIC 1 fisso + 1 scorrevole



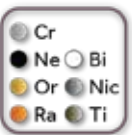

frontali BASIC 1 fisso + 1 scorrevole

Cm	Apertura	TRASPARENTE	FROST PLUS
		Art.	Art.
95-100	36-41	5401	6401
100-105	41-46	5402	6402
105-110	41-46	5403	6403
110-115	46-51	5404	6404
115-120	46-51	5405	6405
120-125	51-56	5406	6406
125-130	51-56	5407	6407
130-135	56-61	5408	6408
135-140	56-61	5409	6409
140-145	61-66	5410	6410
145-150	61-66	5411	6411
150-155	66-71	5412	6412
155-160	66-71	5413	6413
160-165	66-71	5414	6414
165-170	71-76	5415	6415
170-175	71-76	5416	6416
175-180	71-76	5417	6417
180-190	71-76	*5455	*6455
190-200	71-76	*5456	*6456

*L'incrocio delle ante tra i codici 5455, 5456, 6455 e 6456 sarà 1-11 cm.
Composizione per articoli/prezzo a pagina 304.

Descrizione	Art.
Profilo espansione +1,5 cm	5429
Adorno in alluminio 195x3,8 cm	0007



Innovativo sistema di guide con pulsante per liberare l'anta e facilitarne la pulizia



Doppio cuscinetto di ultima generazione in nylon



Adorno in alluminio opzionale



Opzione maniglia	Art.
Extrapiatta 22x1,6x0,7 cm	1731
Lunga 40x1,2x1,5 cm	1732



Box doccia su misura e cristalli speciali	TRASPARENTE	FROST PLUS PARSOL / OPACO
Altezza fino 195 cm	+45%	+60%
Altezza da 195 fino 220 cm	+75%	+90%

*Tempo di consegna 3 settimane (maggiori informazioni a pag. 288)

BASIC 2 fissi + 2 scorrevoli



Descrizione	Estensibilità	Apertura	Incrocio	Art.
BASIC 2F+2S 140 (75+75)	132-142	46-56	1-6	5029+5029+5451
BASIC 2F+2S 150 (80+80)	142-152	56-66	1-6	5019+5019+5451
BASIC 2F+2S 160 (85+85)	152-162	56-66	1-6	5030+5030+5451
BASIC 2F+2S 170 (90+90)	162-172	66-76	1-6	5020+5020+5451
BASIC 2F+2S 180 (95+95)	172-182	66-76	1-6	5031+5031+5454
BASIC 2F+2S 190 (100+100)	182-192	76-86	1-6	5021+5021+5454
BASIC 2F+2S 200 (100+100)	190-200	68-78	1-6	5001+5001+5454
BASIC 2F+2S 210 (105+105)	200-210	80-90	1-6	5002+5002+5454

Si può combinare con il laterale fisso (vedi pag. 66), utilizzando art. 0182 (**indicare il verso**). L'estensibilità aumenta 1,2 cm in uno dei lati.

***Composizione per articoli/prezzo a pagina 304.**

Descrizione	Art.
Profilo espansione +1,5 cm	5429
Profilo di unione fisso-fisso (indicare il verso)	0182

Box doccia su misura e cristalli speciali	TRASP.	FROST PLUS PARSOL / OPACO
Altezza fino 195 cm	+45%	+60%
Altezza 195 fino 220 cm	+75%	+90%

*Tempo di consegna 3 settimane (vedi pag. 288)

BASIC FROST PLUS 2 fissi + 2 scorrevoli



BASIC

Descrizione	Estensibilità	Apertura	Incrocio	Art.
BASIC 2F+2S FROST PLUS 140 (75+75)	132-142	46-56	1-6	6029+6029+5451
BASIC 2F+2S FROST PLUS 150 (80+80)	142-152	56-66	1-6	6019+6019+5451
BASIC 2F+2S FROST PLUS 160 (85+85)	152-162	56-66	1-6	6030+6030+5451
BASIC 2F+2S FROST PLUS 170 (90+90)	162-172	66-76	1-6	6020+6020+5451
BASIC 2F+2S FROST PLUS 180 (95+95)	172-182	66-76	1-6	6031+6031+5454
BASIC 2F+2S FROST PLUS 190 (100+100)	182-192	76-86	1-6	6021+6021+5454
BASIC 2F+2S FROST PLUS 200 (100+100)	190-200	68-78	1-6	6001+6001+5454
BASIC 2F+2S FROST PLUS 210 (105+105)	200-210	80-90	1-6	6002+6002+5454

Si può combinare con il laterale fisso (vedi pag. 66), utilizzando art. 0182 (**indicare il verso**). L'estensibilità aumenta 1,2 cm in uno dei lati.

***Composizione per articoli/prezzo a pagina 304.**

Descrizione	Art.
Profilo espansione +1,5 cm	5429
Profilo di unione fisso-fisso (indicare il verso)	0182

Box doccia su misura e cristalli speciali	TRASP.	FROST PLUS PARSOL/OPACO
Altezza fino 195 cm	+45%	+60%
Altezza 195 fino 220 cm	+75%	+90%

*Tempo di consegna 3 settimane (vedi pag. 288)

BASIC apertura angolare



Box doccia su misura e cristalli speciali	TRASPARENTE	FROST PLUS PARSOL / OPACO
Altezza fino 195 cm	+45%	+60%
Altezza da 195 fino 220 cm	+75%	+90%

*Tempo di consegna 3 settimane (maggiori informazioni a pag. 288)

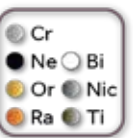

combinazioni **BASIC** apertura angolare

Cm	Estensibilità	Apertura
70x70	65-70/65-70	34-37
75x70	70-75/65-70	36-39
80x70	75-80/65-70	38-41
85x70	80-85/65-70	40-43
90x70	85-90/65-70	41-45
95x70	90-95/65-70	43-47
100x70	95-100/65-70	46-49
110x70	105-109/65-70	47-50
120x70	115-120/65-70	50-53
130x70	125-129/65-70	55-58
140x70	135-139/65-70	59-62
Cm	Estensibilità	Apertura
75x75	70-75/70-75	38-41
80x75	75-80/70-75	40-43
85x75	80-85/70-75	42-45
90x75	85-90/70-75	45-48
95x75	90-95/70-75	47-50
100x75	95-100/70-75	48-51
110x75	105-109/70-75	49-52
120x75	115-120/70-75	52-55
130x75	125-129/70-75	57-60
140x75	135-139/70-75	61-64
Cm	Estensibilità	Apertura
80x80	75-80/75-80	41-44
85x80	80-85/75-80	43-46
90x80	85-90/75-80	45-48
95x80	90-95/75-80	47-50
100x80	95-100/75-80	49-52
110x80	105-109/75-80	50-53
120x80	115-120/75-80	53-56
130x80	125-129/75-80	57-60
140x80	135-139/75-80	62-65
Cm	Estensibilità	Apertura
85x90	80-85/85-90	46-49
90x90	85-90/85-90	48-51
95x90	90-95/85-90	50-53
100x90	95-100/85-90	52-55
110x90	105-109/85-90	53-56
120x90	115-120/85-90	57-62
130x90	125-129/85-90	60-63
140x90	135-139/85-90	64-67

TRASPARENTE
Art.
5018+5018+5423
5029+5018+5423
5019+5018+5423
5030+5018+5423
5020+5018+5423
5031+5018+5423
5021+5018+5423
5002+5018+5423
5022+5018+5423
5006+5018+5424
5008+5018+5424
Art.
5029+5029+5423
5019+5029+5423
5030+5029+5423
5020+5029+5423
5031+5029+5423
5021+5029+5423
5002+5029+5423
5022+5029+5423
5006+5029+5424
5008+5029+5424
Art.
5019+5019+5423
5030+5019+5423
5020+5019+5423
5031+5019+5423
5021+5019+5423
5002+5019+5423
5022+5019+5423
5006+5019+5424
5008+5019+5424
Art.
5030+5020+5423
5020+5020+5423
5031+5020+5423
5021+5020+5423
5002+5020+5423
5022+5020+5423
5006+5020+5424
5008+5020+5424

FROST PLUS
Art.
6018+6018+5423
6029+6018+5423
6019+6018+5423
6030+6018+5423
6020+6018+5423
6031+6018+5423
6021+6018+5423
6002+6018+5423
6022+6018+5423
6006+6018+5424
6008+6018+5424
Art.
6029+6029+5423
6019+6029+5423
6030+6029+5423
6020+6029+5423
6031+6029+5423
6021+6029+5423
6002+6029+5423
6022+6029+5423
6006+6029+5424
6008+6029+5424
Art.
6019+6019+5423
6030+6019+5423
6020+6019+5423
6031+6019+5423
6021+6019+5423
6002+6019+5423
6022+6019+5423
6006+6019+5424
6008+6019+5424
Art.
6030+6020+5423
6020+6020+5423
6031+6020+5423
6021+6020+5423
6002+6020+5423
6022+6020+5423
6006+6020+5424
6008+6020+5424

*Composizione per articoli/prezzo a pagina 304.

Descrizione	Art.
Profilo espansione +1,5 cm	5429

BASIC frontale + laterale fisso 8 mm



Descrizione	Estensibilità	TRASPARENTE		FROST PLUS	
		Art.		Art.	
laterale fisso BASIC 70	66,5-69	5425		6425	
laterale fisso BASIC 75	71,5-74	5457		6457	
laterale fisso BASIC 80	76,5-79	5426		6426	
laterale fisso BASIC 90	86,5-89	5427		6427	
laterale fisso BASIC 100	96,5-99	5430		6430	
laterale fisso BASIC 110	106,5-109	5431		6431	
laterale fisso BASIC 120	116,5-119	5432		6432	



Laterali fissi su misura

Descrizione

misura fino 40 cm

misura da 40 fino 80 cm

misura da 80 fino 120 cm

TRASPARENTE

Art.

1350

1334

1335

FROST PLUS

Art.

1350+1312

1334+1313

1335+1315

*Tempo di consegna 3 settimane



combinazioni frontali **BASIC** + laterale fisso 8 mm

Cm	Estensibilità	Apertura
100x70	95-100/66,5-69	38-43
110x70	105-110/66,5-69	43-48
120x70	115-120/66,5-69	48-53
130x70	125-130/66,5-69	53-58
140x70	135-140/66,5-69	58-63
150x70	145-150/66,5-69	63-68
160x70	155-160/66,5-69	63-68
170x70	165-170/66,5-69	68-73
180x70	175-180/66,5-69	68-73
Cm	Estensibilità	Apertura
100x75	95-100/71,5-74	38-43
110x75	105-110/71,5-74	43-48
120x75	115-120/71,5-74	48-53
130x75	125-130/71,5-74	53-58
140x75	135-140/71,5-74	58-63
150x75	145-150/71,5-74	63-68
160x75	155-160/71,5-74	63-68
170x75	165-170/71,5-74	68-73
180x75	175-180/71,5-74	68-73
Cm	Estensibilità	Apertura
100x80	95-100/76,5-79	38-43
110x80	105-110/76,5-79	43-48
120x80	115-120/76,5-79	48-53
130x80	125-130/76,5-79	53-58
140x80	135-140/76,5-79	58-63
150x80	145-150/76,5-79	63-68
160x80	155-160/76,5-79	63-68
170x80	165-170/76,5-79	68-73
180x80	175-180/76,5-79	68-73
Cm	Estensibilità	Apertura
100x90	95-100/86,5-89	38-43
110x90	105-110/86,5-89	43-48
120x90	115-120/86,5-89	48-53
130x90	125-130/86,5-89	53-58
140x90	135-140/86,5-89	58-63
150x90	145-150/86,5-89	63-68
160x90	155-160/86,5-89	63-68
170x90	165-170/86,5-89	68-73
180x90	175-180/86,5-89	68-73

TRASPARENTE	FROST PLUS
Art.	Art.
5401+5425	6401+6425
5403+5425	6403+6425
5405+5425	6405+6425
5407+5425	6407+6425
5409+5425	6409+6425
5411+5425	6411+6425
5413+5425	6413+6425
5415+5425	6415+6425
5417+5425	6417+6425
Art.	Art.
5401+5457	6401+6457
5403+5457	6403+6457
5405+5457	6405+6457
5407+5457	6407+6457
5409+5457	6409+6457
5411+5457	6411+6457
5413+5457	6413+6457
5415+5457	6415+6457
5417+5457	6417+6457
Art.	Art.
5401+5426	6401+6426
5403+5426	6403+6426
5405+5426	6405+6426
5407+5426	6407+6426
5409+5426	6409+6426
5411+5426	6411+6426
5413+5426	6413+6426
5415+5426	6415+6426
5417+5426	6417+6426
Art.	Art.
5401+5427	6401+6427
5403+5427	6403+6427
5405+5427	6405+6427
5407+5427	6407+6427
5409+5427	6409+6427
5411+5427	6411+6427
5413+5427	6413+6427
5415+5427	6415+6427
5417+5427	6417+6427

BASIC

Si possono fare abbinamenti con misure intermedie dei frontali fino a 2 m

Descrizione	Art.
Profilo espansione +1,5 cm (solo per fisso frontale)	5429
Profilo di unione fisso-fisso(indicare il verso), vedi pag. 158	0182

BASIC NERO/BIANCO 1 fisso + 1 scorrevole



Gomme trasparenti anti-decolorazione



Doppio cuscinetto di ultima generazione in nylon



*Set di 2 gomme verticali nere art. 0014



Innovativo sistema di guide con pulsante per liberare l'anta e facilitarne la pulizia

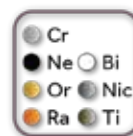
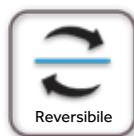
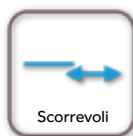

Estensibilità	Apert.	TRASPARENTE		FROST PLUS	
		● NERO	● BIANCO	● NERO	● BIANCO
95-100	36-41	5001+5493	5001+5583	6001+5493	6001+5583
100-105	41-46	5002+5493	5002+5583	6002+5493	6002+5583
105-110	41-46	5003+5493	5003+5583	6003+5493	6003+5583
110-115	46-51	5004+5493	5004+5583	6004+5493	6004+5583
115-120	46-51	5005+5493	5005+5583	6005+5493	6005+5583
120-125	51-56	5006+5493	5006+5583	6006+5493	6006+5583
125-130	51-56	5007+5493	5007+5583	6007+5493	6007+5583
130-135	56-61	5008+5493	5008+5583	6008+5493	6008+5583
135-140	56-61	5009+5493	5009+5583	6009+5493	6009+5583
140-145	61-66	5010+5494	5010+5584	6010+5494	6010+5584
145-150	61-66	5011+5494	5011+5584	6011+5494	6011+5584
150-155	66-71	5012+5494	5012+5584	6012+5494	6012+5584
155-160	66-71	5013+5494	5013+5584	6013+5494	6013+5584
160-165	66-71	5014+5494	5014+5584	6014+5494	6014+5584
165-170	71-76	5015L+5494	5015L+5584	6015L+5494	6015L+5584
170-175	71-76	5016L+5494	5016L+5584	6016L+5494	6016L+5584
175-180	71-76	5017L+5494	5017L+5584	6017L+5494	6017L+5584
180-190	71-76	5023L+5495	5023L+5585	6023L+5495	6023L+5585
190-200	71-76	5024L+5495	5024L+5585	6024L+5495	6024L+5585

Composizione per articoli/prezzo a pagina 304.

	● NERO	● BIANCO
Accessori		
Profilo espansione +1,5 cm	Art. 5477	Art. 5473
Adorno in alluminio 195x3,8 cm	Art. 0007N	Art. 0007B
Opzioni della maniglia		
Maniglia extra piatta 220x16x7mm	Art. 9031	Art. 1731BL
Maniglia lunga 400x12x15mm	Art. 1732N	Art. 1732BL



Adorno nero opzionale



Adorno bianco opzionale



Maniglia nera extrapiatta
220x16x7mm



Maniglia bianca lunga
400x12x15mm



	TRASPARENTE	FROST PLUS PARSOL / OPACO	TAGLIO
Box doccia su misura e cristalli speciali	+45%	+60%	+32

*Tempo di consegna 3 settimane (maggiori informazioni a pag. 288)

BASIC ORO/NICHEL 1 fisso + 1 scorrevole



Gomme trasparenti anti-decolorazione



Doppio cuscinetto di ultima generazione in nylon



Finitura interna/esterna perfetta



Innovativo sistema di guide con pulsante per liberare l'anta e facilitarne la pulizia

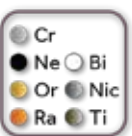

Estensibilità	Apert.	TRASPARENTE		FROST PLUS	
		ORO	NICHEL	ORO	NICHEL
95-100	36-41	5001+5440	5001+5460	6001+5440	6001+5460
100-105	41-46	5002+5440	5002+5460	6002+5440	6002+5460
105-110	41-46	5003+5440	5003+5460	6003+5440	6003+5460
110-115	46-51	5004+5440	5004+5460	6004+5440	6004+5460
115-120	46-51	5005+5440	5005+5460	6005+5440	6005+5460
120-125	51-56	5006+5440	5006+5460	6006+5440	6006+5460
125-130	51-56	5007+5440	5007+5460	6007+5440	6007+5460
130-135	56-61	5008+5440	5008+5460	6008+5440	6008+5460
135-140	56-61	5009+5440	5009+5460	6009+5440	6009+5460
140-145	61-66	5010+5441	5010+5461	6010+5441	6010+5461
145-150	61-66	5011+5441	5011+5461	6011+5441	6011+5461
150-155	66-71	5012+5441	5012+5461	6012+5441	6012+5461
155-160	66-71	5013+5441	5013+5461	6013+5441	6013+5461
160-165	66-71	5014+5441	5014+5461	6014+5441	6014+5461
165-170	71-76	5015L+5441	5015L+5461	6015L+5441	6015L+5461
170-175	71-76	5016L+5441	5016L+5461	6016L+5441	6016L+5461
175-180	71-76	5017L+5441	5017L+5461	6017L+5441	6017L+5461
180-190	71-76	5023L+5442	5023L+5462	6023L+5442	6023L+5462
190-200	71-76	5024L+5442	5024L+5462	6024L+5442	6024L+5462

Composizione per articoli/prezzo a pagina 304.

Accessori	ORO	NICHEL
	Art.	Art.
Profilo espansione +1,5 cm	5474	5475
Adorno in alluminio 195x3,8 cm	0007OR	0007NK
Opzioni della maniglia	Art.	Art.
Maniglia extra piatta 220x16x7mm	1731OR	1731NK
Maniglia lunga 400x12x15mm	1732OR	1732NK



Adorno in alluminio opzionale



Adorno in alluminio opzionale



Maniglia extra piatta oro 220x16x7mm



Maniglia lunga nichel 400x12x15mm



Box doccia su misura e cristalli speciali	TRASPARENTE	FROST PLUS PARSOL / OPACO
	+45%	+60%

*Tempo di consegna 3 settimane (maggiori informazioni a pag. 288)

BASIC

BASIC RAME/TITANIO 1 fisso + 1 scorrevole



Gomme trasparenti anti-decolorazione



Doppio cuscinetto di ultima generazione in nylon



Finitura interna/esterna perfetta



Innovativo sistema di guide con pulsante per liberare l'anta e facilitarne la pulizia

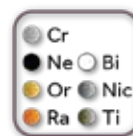
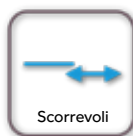

Cm	Apert.	TRASPARENTE		FROST PLUS	
		RAME	TITANIO	RAME	TITANIO
95-100	36-41	5001+5592	5001+5560	6001+5592	6001+5560
100-105	36-41	5002+5592	5002+5560	6002+5592	6002+5560
105-110	41-46	5003+5592	5003+5560	6003+5592	6003+5560
110-115	41-46	5004+5592	5004+5560	6004+5592	6004+5560
115-120	46-51	5005+5592	5005+5560	6005+5592	6005+5560
120-125	46-51	5006+5592	5006+5560	6006+5592	6006+5560
125-130	51-56	5007+5592	5007+5560	6007+5592	6007+5560
130-135	51-56	5008+5592	5008+5560	6008+5592	6008+5560
135-140	56-61	5009+5592	5009+5560	6009+5592	6009+5560
140-145	56-61	5010+5593	5010+5561	6010+5593	6010+5561
145-150	61-66	5011+5593	5011+5561	6011+5593	6011+5561
150-155	61-66	5012+5593	5012+5561	6012+5593	6012+5561
155-160	61-66	5013+5593	5013+5561	6013+5593	6013+5561
160-165	61-66	5014+5593	5014+5561	6014+5593	6014+5561
165-170	66-71	5015L+5593	5015L+5561	6015L+5593	6015L+5561
170-175	66-71	5016L+5593	5016L+5561	6016L+5593	6016L+5561
175-180	66-71	5017L+5593	5017L+5561	6017L+5593	6017L+5561
180-190	66-71	5023L+5594	5023L+5562	6023L+5594	6023L+5562
190-200	66-71	5024L+5594	5024L+5562	6024L+5594	6024L+5562

Composizione per articoli/prezzo a pagina 304.

Accessori	RAME	TITANIO
	Art.	Art.
Profilo espansione +1,5 cm	5476	5478
Adorno in alluminio 195x3,8 cm	0007CB	0007T
Opzioni della maniglia	Art.	Art.
Maniglia extra piatta 220x16x7mm	1731CB	1731T
Maniglia lunga 400x12x15mm	1732CB	1732T



Adorno in alluminio opzionale



Adorno in alluminio opzionale



Maniglia extra piatta rame 220x16x7mm



Maniglia lunga titanio 400x12x15mm



	TRASPARENTE	FROST PLUS PARSOL / OPACO	TAGLIO
Box doccia su misura e cristalli speciali	+45%	+60%	+32

*Tempo di consegna 3 settimane (maggiori informazioni a pag. 288)

BASIC NERA 2 fissi + 2 scorrevoli



Estensibilità	Apert.	Trasparente	Frost Plus
132-142	46-56	5029+5029+5496	6029+6029+5496
142-152	56-66	5019+5019+5496	6019+6019+5496
152-162	56-66	5030+5030+5496	6030+6030+5496
162-172	66-76	5020+5020+5496	6020+6020+5496
172-182	66-76	5031+5031+5497	6031+6031+5497
182-192	76-86	5021+5021+5497	6021+6021+5497
190-200	68-78	5001+5001+5497	6001+6001+5497
200-210	80-90	5002+5002+5497	6002+6002+5497

Si può combinare con il laterale fisso (vedi pag. 87), utilizzando art. 0991 (indicare il verso). L'estensibilità aumenta 1,2 cm in uno dei lati.

***Composizione per articoli/prezzo a pagina 304.**

Accessori	Art.
Profilo espansione +1,5 cm	5477
Adorno in alluminio 195x3,8 cm	0007N
Profilo di unione fisso-fisso (indicare il verso)	0991

Box doccia su misura e cristalli speciali	TRASP.	FROST PLUS PARSOL OPACO
Altezza fino 195 cm	+45%	+60%
Altezza 195 fino 220 cm	+75%	+90%

*Tempo di consegna 3 settimane (vedi pag. 288)

BASIC BIANCA 2 fissi + 2 scorrevoli



BASIC

Estensibilità	Apert.	Trasparente	Frost Plus
132-142	46-56	5029+5029+5586	6029+6029+5586
142-152	56-66	5019+5019+5586	6019+6019+5586
152-162	56-66	5030+5030+5586	6030+6030+5586
162-172	66-76	5020+5020+5586	6020+6020+5586
172-182	66-76	5031+5031+5587	6031+6031+5587
182-192	76-86	5021+5021+5587	6021+6021+5587
190-200	68-78	5001+5001+5587	6001+6001+5587
200-210	80-90	5002+5002+5587	6002+6002+5587

Si può combinare con il laterale fisso (vedi pag. 87), utilizzando art. 0182B (indicare il verso). L'estensibilità aumenta 1,2 cm in uno dei lati.

*Composizione per articoli/prezzo a pagina 304.

Accessori	Art.
Profilo espansione +1,5 cm	5473
Adorno in alluminio 195x3,8 cm	0007B
Profilo di unione fisso-fisso (indicare il verso)	0182B

Box doccia su misura e cristalli speciali	TRASP.	FROST PLUS PARSOL OPACO
Altezza fino 195 cm	+45%	+60%
Altezza 195 fino 220 cm	+75%	+90%

*Tempo di consegna 3 settimane (vedi pag. 288)

BASIC ORO 2 fissi + 2 scorrevoli



Estensibilità	Apert.	Trasparente	Frost Plus
132-142	46-56	5029+5029+5498	6029+6029+5498
142-152	56-66	5019+5019+5498	6019+6019+5498
152-162	56-66	5030+5030+5498	6030+6030+5498
162-172	66-76	5020+5020+5498	6020+6020+5498
172-182	66-76	5031+5031+5499	6031+6031+5499
182-192	76-86	5021+5021+5499	6021+6021+5499
190-200	68-78	5001+5001+5499	6001+6001+5499
200-210	80-90	5002+5002+5499	6002+6002+5499

Si può combinare con il laterale fisso (vedi pag. 89), utilizzando art. 0182OR (indicare il verso). L'estensibilità aumenta 1,2 cm in uno dei lati.

***Composizione per articoli/prezzo a pagina 304.**

Accessori	Art.
Profilo espansione +1,5 cm	5474
Adorno in alluminio 195x3,8 cm	0007OR
Profilo di unione fisso-fisso (indicare il verso)	0182OR

Box doccia su misura e cristalli speciali	TRASP.	FROST PLUS PARSOL / OPACO
Altezza fino 195 cm	+45%	+60%
Altezza 195 fino 220 cm	+75%	+90%

*Tempo di consegna 3 settimane (vedi pag. 288)

BASIC NICHEL 2 fissi + 2 scorrevoli



Estensibilità	Apert.	Trasparente	Frost Plus
132-142	46-56	5029+5029+5465	6029+6029+5465
142-152	56-66	5019+5019+5465	6019+6019+5465
152-162	56-66	5030+5030+5465	6030+6030+5465
162-172	66-76	5020+5020+5465	6020+6020+5465
172-182	66-76	5031+5031+5466	6031+6031+5466
182-192	76-86	5021+5021+5466	6021+6021+5466
190-200	68-78	5001+5001+5466	6001+6001+5466
200-210	80-90	5002+5002+5466	6002+6002+5466

Si può combinare con il laterale fisso (vedi pag. 89), utilizzando art. 0182NK (indicare il verso). L'estensibilità aumenta 1,2 cm in uno dei lati.

***Composizione per articoli/prezzo a pagina 304.**

Accessori	Art.
Profilo espansione +1,5 cm	5475
Adorno in alluminio 195x3,8 cm	0007NK
Profilo di unione fisso-fisso (indicare il verso)	0182NK

Box doccia su misura e cristalli speciali	TRASP.	FROST PLUS PARSOL / OPACO
Altezza fino 195 cm	+45%	+60%
Altezza 195 fino 220 cm	+75%	+90%

*Tempo di consegna 3 settimane (vedi pag. 288)

BASIC RAME 2 fissi + 2 scorrevoli



Estensibilità	Apert.	Trasparente	Frost Plus
132-142	46-56	5029+5029+5595	6029+6029+5595
142-152	56-66	5019+5019+5595	6019+6019+5595
152-162	56-66	5030+5030+5595	6030+6030+5595
162-172	66-76	5020+5020+5595	6020+6020+5595
172-182	66-76	5031+5031+5596	6031+6031+5596
182-192	76-86	5021+5021+5596	6021+6021+5596
190-200	68-78	5001+5001+5596	6001+6001+5596
200-210	80-90	5002+5002+5596	6002+6002+5596

Si può combinare con il laterale fisso (vedi pag. 91), utilizzando art. 0182CB (indicare il verso). L'estensibilità aumenta 1,2 cm in uno dei lati.

***Composizione per articoli/prezzo a pagina 304.**

Accessori	Art.
Profilo espansione +1,5 cm	5476
Adorno in alluminio 195x3,8 cm	0007CB
Profilo di unione fisso-fisso (indicare il verso)	0182CB

Box doccia su misura e cristalli speciali	TRASP.	FROST PLUS PARSOL / OPACO
Altezza fino 195 cm	+45%	+60%
Altezza 195 fino 220 cm	+75%	+90%

*Tempo di consegna 3 settimane (vedi pag. 288)

BASIC TITANIO 2 fissi + 2 scorrevoli



Estensibilità	Apert.	Trasparente	Frost Plus
132-142	46-56	5029+5029+5565	6029+6029+5565
142-152	56-66	5019+5019+5565	6019+6019+5565
152-162	56-66	5030+5030+5565	6030+6030+5565
162-172	66-76	5020+5020+5565	6020+6020+5565
172-182	66-76	5031+5031+5566	6031+6031+5566
182-192	76-86	5021+5021+5566	6021+6021+5566
190-200	68-78	5001+5001+5566	6001+6001+5566
200-210	80-90	5002+5002+5566	6002+6002+5566

Si può combinare con il laterale fisso (vedi pag. 91), utilizzando art. 0182T (indicare il verso). L'estensibilità aumenta 1,2 cm in uno dei lati.

*Composizione per articoli/prezzo a pagina 304.

Accessori	Art.
Profilo espansione +1,5 cm	5478
Adorno in alluminio 195x3,8 cm	0007T
Profilo di unione fisso-fisso (indicare il verso)	0182T

Box doccia su misura e cristalli speciali	TRASP.	FROST PLUS PARSOL / OPACO
Altezza fino 195 cm	+45%	+60%
Altezza 195 fino 220 cm	+75%	+90%

*Tempo di consegna 3 settimane (vedi pag. 288)

BASIC NERO/BIANCO apertura angolare



Gomme trasparenti anti-decolorazione



Doppio cuscinetto di ultima generazione in nylon



*Set di 2 gomme verticali nere art. 0014



Innovativo sistema di guide con pulsante per liberare l'anta e facilitarne la pulizia

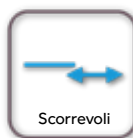

Estensibilità	TRASPARENTE		FROST PLUS	
	● NERO	● BIANCO	● NERO	● BIANCO
combinazioni c/ LATI 70 fisso+scorrevole				
65-70/65-70	5018+5018+5490	5018+5018+5580	6018+6018+5490	6018+6018+5580
70-75/65-70	5029+5018+5490	5029+5018+5580	6029+6018+5490	6029+6018+5580
75-80/65-70	5019+5018+5490	5019+5018+5580	6019+6018+5490	6019+6018+5580
80-85/65-70	5030+5018+5490	5030+5018+5580	6030+6018+5490	6030+6018+5580
85-90/65-70	5020+5018+5490	5020+5018+5580	6020+6018+5490	6020+6018+5580
90-95/65-70	5031+5018+5490	5031+5018+5580	6031+6018+5490	6031+6018+5580
95-100/65-70	5021+5018+5490	5021+5018+5580	6021+6018+5490	6021+6018+5580
105-109/65-70	5002+5018+5490	5002+5018+5580	6002+6018+5490	6002+6018+5580
115-120/65-70	5022+5018+5490	5022+5018+5580	6022+6018+5490	6022+6018+5580
125-129/65-70	5006+5018+5491	5006+5018+5581	6006+6018+5491	6006+6018+5581
135-139/65-70	5008+5018+5491	5008+5018+5581	6008+6018+5491	6008+6018+5581
combinazioni c/ LATI 75 fisso+scorrevole				
70-75/70-75	5029+5029+5490	5029+5029+5580	6029+6029+5490	6029+6029+5580
75-80/70-75	5019+5029+5490	5019+5029+5580	6019+6029+5490	6019+6029+5580
80-85/70-75	5030+5029+5490	5030+5029+5580	6030+6029+5490	6030+6029+5580
85-90/70-75	5020+5029+5490	5020+5029+5580	6020+6029+5490	6020+6029+5580
90-95/70-75	5031+5029+5490	5031+5029+5580	6031+6029+5490	6031+6029+5580
95-100/70-75	5021+5029+5490	5021+5029+5580	6021+6029+5490	6021+6029+5580
105-109/70-75	5002+5029+5490	5002+5029+5580	6002+6029+5490	6002+6029+5580
115-120/70-75	5022+5029+5490	5022+5029+5580	6022+6029+5490	6022+6029+5580
125-129/70-75	5006+5029+5491	5006+5029+5581	6006+6029+5491	6006+6029+5581
135-139/70-75	5008+5029+5491	5008+5029+5581	6008+6029+5491	6008+6029+5581
combinazioni c/ LATI 80 fisso+scorrevole				
75-80/75-80	5019+5019+5490	5019+5019+5580	6019+6019+5490	6019+6019+5580
80-85/75-80	5030+5019+5490	5030+5019+5580	6030+6019+5490	6030+6019+5580
85-90/75-80	5020+5019+5490	5020+5019+5580	6020+6019+5490	6020+6019+5580
90-95/75-80	5031+5019+5490	5031+5019+5580	6031+6019+5490	6031+6019+5580
95-100/75-80	5021+5019+5490	5021+5019+5580	6021+6019+5490	6021+6019+5580
105-109/75-80	5002+5019+5490	5002+5019+5580	6002+6019+5490	6002+6019+5580
115-120/75-80	5022+5019+5490	5022+5019+5580	6022+6019+5490	6022+6019+5580
125-129/75-80	5006+5019+5491	5006+5019+5581	6006+6019+5491	6006+6019+5581
135-139/75-80	5008+5019+5491	5008+5019+5581	6008+6019+5491	6008+6019+5581
combinazioni c/ LATI 90 fisso+scorrevole				
85-90/85-90	5020+5020+5490	5020+5020+5580	6020+6020+5490	6020+6020+5580
90-95/85-90	5031+5020+5490	5031+5020+5580	6031+6020+5490	6031+6020+5580
95-100/85-90	5021+5020+5490	5021+5020+5580	6021+6020+5490	6021+6020+5580
105-109/85-90	5002+5020+5490	5002+5020+5580	6002+6020+5490	6002+6020+5580
115-120/85-90	5022+5020+5490	5022+5020+5580	6022+6020+5490	6022+6020+5580
125-129/85-90	5006+5020+5491	5006+5020+5581	6006+6020+5491	6006+6020+5581
135-139/85-90	5008+5020+5491	5008+5020+5581	6008+6020+5491	6008+6020+5581

Composizione per articoli/prezzo a pagina 304. Apertura vedi pagina 65.

BASIC ORO/NICHEL apertura angolare



Gomme trasparenti anti-decolorazione



Doppio cuscinetto di ultima generazione in nylon



Finitura interna/esterna perfetta



Innovativo sistema di guide con pulsante per liberare l'anta e facilitarne la pulizia

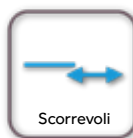

Estensibilità	TRASPARENTE		FROST PLUS	
	ORO	NICHEL	ORO	NICHEL
combinazioni c/ LATI 70 fisso+scorrevole				
65-70/65-70	5018+5018+5448	5018+5018+5463	6018+6018+5448	6018+6018+5463
70-75/65-70	5029+5018+5448	5029+5018+5463	6029+6018+5448	6029+6018+5463
75-80/65-70	5019+5018+5448	5019+5018+5463	6019+6018+5448	6019+6018+5463
80-85/65-70	5030+5018+5448	5030+5018+5463	6030+6018+5448	6030+6018+5463
85-90/65-70	5020+5018+5448	5020+5018+5463	6020+6018+5448	6020+6018+5463
90-95/65-70	5031+5018+5448	5031+5018+5463	6031+6018+5448	6031+6018+5463
95-100/65-70	5021+5018+5448	5021+5018+5463	6021+6018+5448	6021+6018+5463
105-109/65-70	5002+5018+5448	5002+5018+5463	6002+6018+5448	6002+6018+5463
115-120/65-70	5022+5018+5448	5022+5018+5463	6022+6018+5448	6022+6018+5463
125-129/65-70	5006+5018+5449	5006+5018+5464	6006+6018+5449	6006+6018+5464
135-139/65-70	5008+5018+5449	5008+5018+5464	6008+6018+5449	6008+6018+5464
combinazioni c/ LATI 75 fisso+scorrevole				
70-75/70-75	5029+5029+5448	5029+5029+5463	6029+6029+5448	6029+6029+5463
75-80/70-75	5019+5029+5448	5019+5029+5463	6019+6029+5448	6019+6029+5463
80-85/70-75	5030+5029+5448	5030+5029+5463	6030+6029+5448	6030+6029+5463
85-90/70-75	5020+5029+5448	5020+5029+5463	6020+6029+5448	6020+6029+5463
90-95/70-75	5031+5029+5448	5031+5029+5463	6031+6029+5448	6031+6029+5463
95-100/70-75	5021+5029+5448	5021+5029+5463	6021+6029+5448	6021+6029+5463
105-109/70-75	5002+5029+5448	5002+5029+5463	6002+6029+5448	6002+6029+5463
115-120/70-75	5022+5029+5448	5022+5029+5463	6022+6029+5448	6022+6029+5463
125-129/70-75	5006+5029+5449	5006+5029+5464	6006+6029+5449	6006+6029+5464
135-139/70-75	5008+5029+5449	5008+5029+5464	6008+6029+5449	6008+6029+5464
combinazioni c/ LATI 80 fisso+scorrevole				
75-80/75-80	5019+5019+5448	5019+5019+5463	6019+6019+5448	6019+6019+5463
80-85/75-80	5030+5019+5448	5030+5019+5463	6030+6019+5448	6030+6019+5463
85-90/75-80	5020+5019+5448	5020+5019+5463	6020+6019+5448	6020+6019+5463
90-95/75-80	5031+5019+5448	5031+5019+5463	6031+6019+5448	6031+6019+5463
95-100/75-80	5021+5019+5448	5021+5019+5463	6021+6019+5448	6021+6019+5463
105-109/75-80	5002+5019+5448	5002+5019+5463	6002+6019+5448	6002+6019+5463
115-120/75-80	5022+5019+5448	5022+5019+5463	6022+6019+5448	6022+6019+5463
125-129/75-80	5006+5019+5449	5006+5019+5464	6006+6019+5449	6006+6019+5464
135-139/75-80	5008+5019+5449	5008+5019+5464	6008+6019+5449	6008+6019+5464
combinazioni c/ LATI 90 fisso+scorrevole				
85-90/85-90	5020+5020+5448	5020+5020+5463	6020+6020+5448	6020+6020+5463
90-95/85-90	5031+5020+5448	5031+5020+5463	6031+6020+5448	6031+6020+5463
95-100/85-90	5021+5020+5448	5021+5020+5463	6021+6020+5448	6021+6020+5463
105-109/85-90	5002+5020+5448	5002+5020+5463	6002+6020+5448	6002+6020+5463
115-120/85-90	5022+5020+5448	5022+5020+5463	6022+6020+5448	6022+6020+5463
125-129/85-90	5006+5020+5449	5006+5020+5464	6006+6020+5449	6006+6020+5464
135-139/85-90	5008+5020+5449	5008+5020+5464	6008+6020+5449	6008+6020+5464

Composizione per articoli/prezzo a pagina 304. Apertura vedi pagina 65.

BASIC RAME/TITANIO apertura angolare



Gomme trasparenti anti-decolorazione



Doppio cuscinetto di ultima generazione in nylon



Finitura interna/esterna perfetta



Innovativo sistema di guide con pulsante per liberare l'anta e facilitarne la pulizia



Estensibilità	TRASPARENTE		FROST PLUS	
	RAME	TITANIO	RAME	TITANIO
combinazioni c/ LATI 70 fisso+scorrevole				
65-70/65-70	5018+5018+5590	5018+5018+5563	6018+6018+5590	6018+6018+5563
70-75/65-70	5029+5018+5590	5029+5018+5563	6029+6018+5590	6029+6018+5563
75-80/65-70	5019+5018+5590	5019+5018+5563	6019+6018+5590	6019+6018+5563
80-85/65-70	5030+5018+5590	5030+5018+5563	6030+6018+5590	6030+6018+5563
85-90/65-70	5020+5018+5590	5020+5018+5563	6020+6018+5590	6020+6018+5563
90-95/65-70	5031+5018+5590	5031+5018+5563	6031+6018+5590	6031+6018+5563
95-100/65-70	5021+5018+5590	5021+5018+5563	6021+6018+5590	6021+6018+5563
105-109/65-70	5002+5018+5590	5002+5018+5563	6002+6018+5590	6002+6018+5563
115-120/65-70	5022+5018+5590	5022+5018+5563	6022+6018+5590	6022+6018+5563
125-129/65-70	5006+5018+5591	5006+5018+5564	6006+6018+5591	6006+6018+5564
135-139/65-70	5008+5018+5591	5008+5018+5564	6008+6018+5591	6008+6018+5564
combinazioni c/ LATI 75 fisso+scorrevole				
70-75/70-75	5029+5029+5590	5029+5029+5563	6029+6029+5590	6029+6029+5563
75-80/70-75	5019+5029+5590	5019+5029+5563	6019+6029+5590	6019+6029+5563
80-85/70-75	5030+5029+5590	5030+5029+5563	6030+6029+5590	6030+6029+5563
85-90/70-75	5020+5029+5590	5020+5029+5563	6020+6029+5590	6020+6029+5563
90-95/70-75	5031+5029+5590	5031+5029+5563	6031+6029+5590	6031+6029+5563
95-100/70-75	5021+5029+5590	5021+5029+5563	6021+6029+5590	6021+6029+5563
105-109/70-75	5002+5029+5590	5002+5029+5563	6002+6029+5590	6002+6029+5563
115-120/70-75	5022+5029+5590	5022+5029+5563	6022+6029+5590	6022+6029+5563
125-129/70-75	5006+5029+5591	5006+5029+5564	6006+6029+5591	6006+6029+5564
135-139/70-75	5008+5029+5591	5008+5029+5564	6008+6029+5591	6008+6029+5564
combinazioni c/ LATI 80 fisso+scorrevole				
75-80/75-80	5019+5019+5590	5019+5019+5563	6019+6019+5590	6019+6019+5563
80-85/75-80	5030+5019+5590	5030+5019+5563	6030+6019+5590	6030+6019+5563
85-90/75-80	5020+5019+5590	5020+5019+5563	6020+6019+5590	6020+6019+5563
90-95/75-80	5031+5019+5590	5031+5019+5563	6031+6019+5590	6031+6019+5563
95-100/75-80	5021+5019+5590	5021+5019+5563	6021+6019+5590	6021+6019+5563
105-109/75-80	5002+5019+5590	5002+5019+5563	6002+6019+5590	6002+6019+5563
115-120/75-80	5022+5019+5590	5022+5019+5563	6022+6019+5590	6022+6019+5563
125-129/75-80	5006+5019+5591	5006+5019+5564	6006+6019+5591	6006+6019+5564
135-139/75-80	5008+5019+5591	5008+5019+5564	6008+6019+5591	6008+6019+5564
combinazioni c/ LATI 90 fisso+scorrevole				
85-90/85-90	5020+5020+5590	5020+5020+5563	6020+6020+5590	6020+6020+5563
90-95/85-90	5031+5020+5590	5031+5020+5563	6031+6020+5590	6031+6020+5563
95-100/85-90	5021+5020+5590	5021+5020+5563	6021+6020+5590	6021+6020+5563
105-109/85-90	5002+5020+5590	5002+5020+5563	6002+6020+5590	6002+6020+5563
115-120/85-90	5022+5020+5590	5022+5020+5563	6022+6020+5590	6022+6020+5563
125-129/85-90	5006+5020+5591	5006+5020+5564	6006+6020+5591	6006+6020+5564
135-139/85-90	5008+5020+5591	5008+5020+5564	6008+6020+5591	6008+6020+5564

Composizione per articoli/prezzo a pagina 304. Apertura vedi pagina 65.

BASIC NERO/BIANCO frontale + laterale fisso 8mm



Gomme trasparenti anti-decolorazione



Doppio cuscinetto di ultima generazione in nylon



*Set di 2 gomme verticali nere art. 0014



Innovativo sistema di guide con pulsante per liberare l'anta e facilitarne la pulizia

PASSO 1: PROFILI

Descrizione
Accessori frontali fino a 140 cm + kit laterale
Accessori frontali fino a 180 cm + kit laterale

● NERO	● BIANCO
Art.	Art.
5493+5492	5583+5588
5494+5492	5584+5588

PASSO 2: FRONTALI+LAT. FISSO

Cm	Estensibilità (cm)	TRASPARENTE	FROST PLUS
		Art.	Art.
combinazioni c/ Laterale fisso da 70			
100x70	Cristalli da 95-100/66,5-69	5001+5025	6001+6025
110x70	Cristalli da 105-110/66,5-69	5003+5025	6003+6025
120x70	Cristalli da 115-120/66,5-69	5005+5025	6005+6025
130x70	Cristalli da 125-130/66,5-69	5007+5025	6007+6025
140x70	Cristalli da 135-140/66,5-69	5009+5025	6009+6025
150x70	Cristalli da 145-150/66,5-69	5011+5025	6011+6025
160x70	Cristalli da 155-160/66,5-69	5013+5025	6013+6025
170x70	Cristalli da 165-170/66,5-69	5015L+5025	6015L+6025
180x70	Cristalli da 175-180/66,5-69	5017L+5025	6017L+6025
combinazioni c/ Laterale fisso da 75			
100x75	Cristalli da 95-100/71,5-74	5001+5057	6001+6057
110x75	Cristalli da 105-110/71,5-74	5003+5057	6003+6057
120x75	Cristalli da 115-120/71,5-74	5005+5057	6005+6057
130x75	Cristalli da 125-130/71,5-74	5007+5057	6007+6057
140x75	Cristalli da 135-140/71,5-74	5009+5057	6009+6057
150x75	Cristalli da 145-150/71,5-74	5011+5057	6011+6057
160x75	Cristalli da 155-160/71,5-74	5013+5057	6013+6057
170x75	Cristalli da 165-170/71,5-74	5015L+5057	6015L+6057
180x75	Cristalli da 175-180/71,5-74	5017L+5057	6017L+6057
combinazioni c/ Laterale fisso da 80			
100x80	Cristalli da 95-100/76,5-79	5001+5026	6001+6026
110x80	Cristalli da 105-110/76,5-79	5003+5026	6003+6026
120x80	Cristalli da 115-120/76,5-79	5005+5026	6005+6026
130x80	Cristalli da 125-130/76,5-79	5007+5026	6007+6026
140x80	Cristalli da 135-140/76,5-79	5009+5026	6009+6026
150x80	Cristalli da 145-150/76,5-79	5011+5026	6011+6026
160x80	Cristalli da 155-160/76,5-79	5013+5026	6013+6026
170x80	Cristalli da 165-170/76,5-79	5015L+5026	6015L+6026
180x80	Cristalli da 175-180/76,5-79	5017L+5026	6017L+6026
combinazioni c/ Laterale fisso da 90			
100x90	Cristalli da 95-100/86,5-89	5001+5027	6001+6027
110x90	Cristalli da 105-110/86,5-89	5003+5027	6003+6027
120x90	Cristalli da 115-120/86,5-89	5005+5027	6005+6027
130x90	Cristalli da 125-130/86,5-89	5007+5027	6007+6027
140x90	Cristalli da 135-140/86,5-89	5009+5027	6009+6027
150x90	Cristalli da 145-150/86,5-89	5011+5027	6011+6027
160x90	Cristalli da 155-160/86,5-89	5013+5027	6013+6027
170x90	Cristalli da 165-170/86,5-89	5015L+5027	6015L+6027
180x90	Cristalli da 175-180/86,5-89	5017L+5027	6017L+6027

*Opzione profilo di unione fisso-fisso (**indicare il verso**). Art. NERO: **0991** | Art. BIANCO: **0182B**

*Altre misure con lati fissi di 100, 110, 120 e frontali intermedi vedi pag. 304

BASIC ORO/NICHEL frontale + laterale fisso 8mm



Gomme trasparenti anti-decolorazione



Doppio cuscinetto di ultima generazione in nylon



Finitura interna/esterna perfetta



Innovativo sistema di guide con pulsante per liberare l'anta e facilitarne la pulizia

PASSO 1: PROFILI

Descrizione
Accessori frontali fino a 140 cm + kit laterale
Accessori frontali fino a 180 cm + kit laterale

ORO	NICHEL
Art.	Art.
5440+5445	5460+5469
5441+5445	5461+5469

PASSO 2: FRONTALI+LAT. FISSI

Cm	Estensibilità (cm)	TRASPARENTE	FROST PLUS
		Art.	Art.
combinazioni c/ Laterale fisso da 70			
100x70	Cristalli da 95-100/66,5-69	5001+5025	6001+6025
110x70	Cristalli da 105-110/66,5-69	5003+5025	6003+6025
120x70	Cristalli da 115-120/66,5-69	5005+5025	6005+6025
130x70	Cristalli da 125-130/66,5-69	5007+5025	6007+6025
140x70	Cristalli da 135-140/66,5-69	5009+5025	6009+6025
150x70	Cristalli da 145-150/66,5-69	5011+5025	6011+6025
160x70	Cristalli da 155-160/66,5-69	5013+5025	6013+6025
170x70	Cristalli da 165-170/66,5-69	5015L+5025	6015L+6025
180x70	Cristalli da 175-180/66,5-69	5017L+5025	6017L+6025
combinazioni c/ Laterale fisso da 75			
100x75	Cristalli da 95-100/71,5-74	5001+5057	6001+6057
110x75	Cristalli da 105-110/71,5-74	5003+5057	6003+6057
120x75	Cristalli da 115-120/71,5-74	5005+5057	6005+6057
130x75	Cristalli da 125-130/71,5-74	5007+5057	6007+6057
140x75	Cristalli da 135-140/71,5-74	5009+5057	6009+6057
150x75	Cristalli da 145-150/71,5-74	5011+5057	6011+6057
160x75	Cristalli da 155-160/71,5-74	5013+5057	6013+6057
170x75	Cristalli da 165-170/71,5-74	5015L+5057	6015L+6057
180x75	Cristalli da 175-180/71,5-74	5017L+5057	6017L+6057
combinazioni c/ Laterale fisso da 80			
100x80	Cristalli da 95-100/76,5-79	5001+5026	6001+6026
110x80	Cristalli da 105-110/76,5-79	5003+5026	6003+6026
120x80	Cristalli da 115-120/76,5-79	5005+5026	6005+6026
130x80	Cristalli da 125-130/76,5-79	5007+5026	6007+6026
140x80	Cristalli da 135-140/76,5-79	5009+5026	6009+6026
150x80	Cristalli da 145-150/76,5-79	5011+5026	6011+6026
160x80	Cristalli da 155-160/76,5-79	5013+5026	6013+6026
170x80	Cristalli da 165-170/76,5-79	5015L+5026	6015L+6026
180x80	Cristalli da 175-180/76,5-79	5017L+5026	6017L+6026
combinazioni c/ Laterale fisso da 90			
100x90	Cristalli da 95-100/86,5-89	5001+5027	6001+6027
110x90	Cristalli da 105-110/86,5-89	5003+5027	6003+6027
120x90	Cristalli da 115-120/86,5-89	5005+5027	6005+6027
130x90	Cristalli da 125-130/86,5-89	5007+5027	6007+6027
140x90	Cristalli da 135-140/86,5-89	5009+5027	6009+6027
150x90	Cristalli da 145-150/86,5-89	5011+5027	6011+6027
160x90	Cristalli da 155-160/86,5-89	5013+5027	6013+6027
170x90	Cristalli da 165-170/86,5-89	5015L+5027	6015L+6027
180x90	Cristalli da 175-180/86,5-89	5017L+5027	6017L+6027

*Opzione profilo di unione fisso-fisso (**indicare il verso**). Art. ORO: **0182OR** | Art. NICHEL: **0182NK**

*Altre misure con lati fissi di 100, 110, 120 e frontali intermedi vedi pag. 304

BASIC RAME/TITANIO frontale + laterale fisso 8mm



Gomme trasparenti anti-decolorazione



Doppio cuscinetto di ultima generazione in nylon



Finitura interna/esterna perfetta



Innovativo sistema di guide con pulsante per liberare l'anta e facilitarne la pulizia

PASSO 1: PROFILI

Descrizione
Accessori frontali fino a 140 cm + kit laterale
Accessori frontali fino a 180 cm + kit laterale

RAME	TITANIO
Art.	Art.
5592+5597	5560+5567
5593+5597	5561+5567

PASSO 2: FRONTALI+LAT. FISSI

Cm	Estensibilità (cm)	TRASPARENTE	FROST PLUS
		Art.	Art.
combinazioni c/ Laterale fisso da 70			
100x70	Cristalli da 95-100/66,5-69	5001+5025	6001+6025
110x70	Cristalli da 105-110/66,5-69	5003+5025	6003+6025
120x70	Cristalli da 115-120/66,5-69	5005+5025	6005+6025
130x70	Cristalli da 125-130/66,5-69	5007+5025	6007+6025
140x70	Cristalli da 135-140/66,5-69	5009+5025	6009+6025
150x70	Cristalli da 145-150/66,5-69	5011+5025	6011+6025
160x70	Cristalli da 155-160/66,5-69	5013+5025	6013+6025
170x70	Cristalli da 165-170/66,5-69	5015L+5025	6015L+6025
180x70	Cristalli da 175-180/66,5-69	5017L+5025	6017L+6025
combinazioni c/ Laterale fisso da 75			
100x75	Cristalli da 95-100/71,5-74	5001+5057	6001+6057
110x75	Cristalli da 105-110/71,5-74	5003+5057	6003+6057
120x75	Cristalli da 115-120/71,5-74	5005+5057	6005+6057
130x75	Cristalli da 125-130/71,5-74	5007+5057	6007+6057
140x75	Cristalli da 135-140/71,5-74	5009+5057	6009+6057
150x75	Cristalli da 145-150/71,5-74	5011+5057	6011+6057
160x75	Cristalli da 155-160/71,5-74	5013+5057	6013+6057
170x75	Cristalli da 165-170/71,5-74	5015L+5057	6015L+6057
180x75	Cristalli da 175-180/71,5-74	5017L+5057	6017L+6057
combinazioni c/ Laterale fisso da 80			
100x80	Cristalli da 95-100/76,5-79	5001+5026	6001+6026
110x80	Cristalli da 105-110/76,5-79	5003+5026	6003+6026
120x80	Cristalli da 115-120/76,5-79	5005+5026	6005+6026
130x80	Cristalli da 125-130/76,5-79	5007+5026	6007+6026
140x80	Cristalli da 135-140/76,5-79	5009+5026	6009+6026
150x80	Cristalli da 145-150/76,5-79	5011+5026	6011+6026
160x80	Cristalli da 155-160/76,5-79	5013+5026	6013+6026
170x80	Cristalli da 165-170/76,5-79	5015L+5026	6015L+6026
180x80	Cristalli da 175-180/76,5-79	5017L+5026	6017L+6026
combinazioni c/ Laterale fisso da 90			
100x90	Cristalli da 95-100/86,5-89	5001+5027	6001+6027
110x90	Cristalli da 105-110/86,5-89	5003+5027	6003+6027
120x90	Cristalli da 115-120/86,5-89	5005+5027	6005+6027
130x90	Cristalli da 125-130/86,5-89	5007+5027	6007+6027
140x90	Cristalli da 135-140/86,5-89	5009+5027	6009+6027
150x90	Cristalli da 145-150/86,5-89	5011+5027	6011+6027
160x90	Cristalli da 155-160/86,5-89	5013+5027	6013+6027
170x90	Cristalli da 165-170/86,5-89	5015L+5027	6015L+6027
180x90	Cristalli da 175-180/86,5-89	5017L+5027	6017L+6027

*Opzione profilo di unione fisso-fisso (**indicare il verso**). Art. RAME: **0182CB** | Art. TITANIO: **0182T**

*Altre misure con lati fissi di 100, 110, 120 e frontali intermedi vedi pag. 304

BASIC fisso + porta + fisso



Estensibilità = Estensibilità Min/Max frontale + misura fisso in linea

Configuratelo a vostro
piacimento nel nostro B2B
vedi pagina 237

PASSO 1: PROFILI

Descrizione	CROMO	NERO	BIANCO
	Art.	Art.	Art.
Accessori fino a 140 cm	5434+5467	5493+5467N	5583+5467B
Accessori fino 180 cm	5438+5467	5494+5467N	5584+5467B
Accessori fino 200 cm	5446+5467	5495+5467N	5585+5467B

Descrizione	ORO	NICHEL	RAME	TITANIO
	Art.	Art.	Art.	Art.
Accessori fino a 140 cm	5440+5467OR	5460+5467NK	5592+5467CB	5560+5467T
Accessori fino 180 cm	5441+5467OR	5461+5467NK	5593+5467CB	5561+5467T
Accessori fino 200 cm	5442+5467OR	5462+5467NK	5594+5467CB	5562+5467T

PASSO 2: FISSO IN LINEA

Cm fisso	TRASPARENTE	FROST PLUS
	Art.	Art.
Fisso da 30 cm	5018F	6018F
Fisso da 35 cm	5019F	6019F
Fisso da 40 cm	5020F	6020F
Fisso da 45 cm	5021F	6021F
Fisso da 52 cm	5002F	6002F
Fisso da 55 cm	5022F	6022F
Fisso da 57 cm	5004F	6004F

PASSO 3: FRONTALI

Descrizione	Estensibilità	TRASPARENTE	FROST PLUS
		Art.	Art.
Fisso + Porta frontale da 100	95-100	5001	6001
Fisso + Porta frontale da 105	100-105	5002	6002
Fisso + Porta frontale da 110	105-110	5003	6003
Fisso + Porta frontale da 115	110-115	5004	6004
Fisso + Porta frontale da 120	115-120	5005	6005
Fisso + Porta frontale da 125	120-125	5006	6006
Fisso + Porta frontale da 130	125-130	5007	6007
Fisso + Porta frontale da 135	130-135	5008	6008
Fisso + Porta frontale da 140	135-140	5009	6009
Fisso + Porta frontale da 145	140-145	5010	6010
Fisso + Porta frontale da 150	145-150	5011	6011
Fisso + Porta frontale da 155	150-155	5012	6012
Fisso + Porta frontale da 160	155-160	5013	6013
Fisso + Porta frontale da 165	160-165	5014	6014
Fisso + Porta frontale da 170	165-170	5015L	6015L
Fisso + Porta frontale da 175	170-175	5016L	6016L
Fisso + Porta frontale da 180	175-180	5017L	6017L
Fisso + Porta frontale da 190	180-190	5023L	6023L
Fisso + Porta frontale da 200	190-200	5024L	6024L

A misura e speciali, vedi pag. 288

BASIC FREE



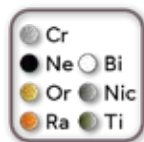
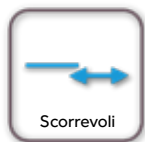
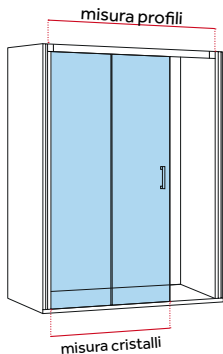

PASSO 1: Selezionare la misura/colore dei PROFILI

PASSO 2: Selezionare la misura/finitura dei CRISTALLI

PASSO 1: PROFILI

Descrizione	CROMO	NERO	BIANCO
	Art.	Art.	Art.
Prof. e acc. fino a 140 + KIT FREE	5434+5447	5493+5447N	5583+5447B
Prof. e acc. fino a 180 + KIT FREE	5438+5447	5494+5447N	5584+5447B
Prof. e acc. fino a 200 + KIT FREE	5446+5447	5495+5447N	5585+5447B

Descrizione	ORO	NICHEL	RAME	TITANIO
	Art.	Art.	Art.	Art.
Prof. e acc. fino a 140 + KIT FREE	5440+5447OR	5460+5447NK	5592+5447CB	5560+5447T
Prof. e acc. fino a 180 + KIT FREE	5441+5447OR	5461+5447NK	5593+5447CB	5561+5447T
Prof. e acc. fino a 200 + KIT FREE	5442+5447OR	5462+5447NK	5594+5447CB	5562+5447T

PASSO 2: CRISTALLI

Estensibilità (cm)	TRASPARENTE	FROST PLUS
	Art.	Art.
Cristalli da 95-100	5001	6001
Cristalli da 100-105	5002	6002
Cristalli da 105-110	5003	6003
Cristalli da 110-115	5004	6004
Cristalli da 115-120	5005	6005
Cristalli da 120-125	5006	6006
Cristalli da 125-130	5007	6007
Cristalli da 130-135	5008	6008
Cristalli da 135-140	5009	6009
Cristalli da 140-145	5010	6010
Cristalli da 145-150	5011	6011
Cristalli da 150-155	5012	6012
Cristalli da 155-160	5013	6013
Cristalli da 160-165	5014	6014
Cristalli da 165-170	5015L	6015L
Cristalli da 170-175	5016L	6016L
Cristalli da 175-180	5017L	6017L
Cristalli da 180-190	5023L	6023L
Cristalli da 190-200	5024L	6024L



	TRASPARENTE	FROST PLUS PARSOL / OPACO
Box doccia su misura e cristalli speciali	+45%	+60%

*Tempo di consegna 3 settimane (maggiori informazioni a pag. 288)

BASIC FREE ANGOLARE



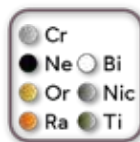
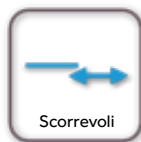

PASSO 1: Selezionare la misura/colore dei PROFILI ANGOLARE

PASSO 2: Selezionare la misura/finitura dei CRISTALLI

PASSO 1: PROFILI

Descrizione

Acc. fino a **120x90** cm + KIT FREE

Acc. fino a **140x100** cm + KIT FREE

CROMO	NERO	BIANCO
Art.	Art.	Art.
5423+5447	5490+5447N	5580+5447B
5424+5447	5491+5447N	5581+5447B

Descrizione

Acc. fino a **120x90** cm + KIT FREE

Acc. fino a **140x100** cm + KIT FREE

ORO	NICHEL	RAME	TITANIO
Art.	Art.	Art.	Art.
5448+5447OR	5463+5447NK	5590+5447CB	5563+5447T
5449+5447OR	5464+5447NK	5591+5447CB	5564+5447T

PASSO 2: CRISTALLI

Estensibilità (frontale / lato free)

65-70 / 65-100

70-75 / 65-100

75-80 / 65-100

80-85 / 65-100

85-90 / 65-100

90-95 / 65-100

95-100 / 65-100

105-109 / 65-100

115-120 / 65-100

125-129 / 65-100

135-139 / 65-100

TRASPARENTE	FROST PLUS
Art.	Art.
5018	6018
5029	6029
5019	6019
5030	6030
5020	6020
5031	6031
5021	6021
5002	6002
5022	6022
5006	6006
5008	6008

*Composizione per articoli/prezzo a pagina 304.

Descrizione	Art.
Profilo espansione +1,5 cm cromo	5429
Profilo espansione +1,5 cm nero	5477
Profilo espansione +1,5 cm bianco	5473
Profilo espansione +1,5 cm oro	5474
Profilo espansione +1,5 cm nicHEL	5475
Profilo espansione +1,5 cm rame	5476
Profilo espansione +1,5 cm titanio	5478



Box doccia su misura e cristalli speciali	TRASPARENTE	FROST PLUS PARSOL / OPACO
Altezza fino 195 cm	+45%	+60%
Altezza da 195 fino 220 cm	+75%	+90%

*Tempo di consegna 3 settimane (maggiori informazioni a pag. 288)

prestige

"Affidabilità e prestazioni
al miglior prezzo"





PRESTIGE semicircolare



Descrizione	Cm	Apert.	TRASPAREN- TE	FROST PLUS
			Art.	Art.
80x80 RAGGIO ITALIANO R55	76,5-79,5	46	0011	0052
90x90 RAGGIO ITALIANO R55	86,5-89,5	52	0013	0053
75x75 RAGGIO ROCA R50	71,5-74,5	39	0044	-
80x80 RAGGIO ROCA R50	76,5-79,5	46	0046	0048
90x90 RAGGIO ROCA R50	86,5-89,5	52	0047	0049
Profilo espansione +2 cm			0218	
Profilo espansione +4 cm			0029	

PRESTIGE NERA semicircolare

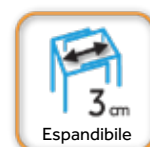
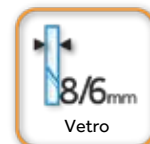
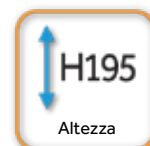

PREST/AKT

Descrizione	Cm	Apertura	Art.
80x80 RAGGIO ITALIANO R55	76,5-79,5	46	0011N
90x90 RAGGIO ITALIANO R55	86,5-89,5	52	0013N
75x75 RAGGIO ROCA R50	71,5-74,5	39	0044N
80x80 RAGGIO ROCA R50	76,5-79,5	46	0046N
90x90 RAGGIO ROCA R50	86,5-89,5	52	0047N
Profilo espansione +2 cm			9016

PRESTIGE 1 fisso+1 scorrevole



Descrizione	Estensibilità	Apertura	TRASPARENTE	FROST PLUS
			Art.	Art.
PRESTIGE 1F+1S 100X195	97-103	38	0200	0272
PRESTIGE 1F+1S 110X195	107-113	43	0201	0273
PRESTIGE 1F+1S 120X195	117-123	48	0202	0274
PRESTIGE 1F+1S 130X195	127-133	53	0203	0275
PRESTIGE 1F+1S 140X195	137-143	58	0204	0276
PRESTIGE 1F+1S 150X195	147-153	63	0205	0277
PRESTIGE 1F+1S 160X195	157-163	58	0206	0278
PRESTIGE 1F+1S 170X195	167-173	63	0207	0279
Profilo espansione +2 cm				0218
Profilo espansione +4 cm				0029

*Si può abbinare al Laterale Fisso STD (vedi pag. 106), l'estensibilità aumenta di 0,7 e si perde l'espansione nel lato in cui si installa il fisso.

PRESTIGE 2 fissi+2 scorrevoli



PREST/AKT

Descrizione	Estensibilità	Apertura	TRASPARENTE	FROST PLUS
			Art.	Art.
PRESTIGE 2F+2S 140X195	136-142	53	0610	0616
PRESTIGE 2F+2S 150X195	146-152	58	0611	0617
PRESTIGE 2F+2S 160X195	156-162	63	0612	0618
PRESTIGE 2F+2S 170X195	166-172	68	0613	0619
PRESTIGE 2F+2S 180X195	176-182	73	0614	0620
PRESTIGE 2F+2S 190X195	186-192	78	0615	0621
Profilo espansione +2 cm				0218
Profilo espansione +4 cm				0029

*Si può abbinare al Laterale Fisso STD (vedi pag. 106), l'estensibilità aumenta di 0,7 e si perde l'espansione nel lato in cui si installa il fisso.

PRESTIGE apertura angolare



Descrizione	TRASPARENTE	FROST PLUS
	Art.	Art.
Lato 70x195 cm PRESTIGE	0313	0295
Lato 75x195 cm PRESTIGE	0375	0294
Lato 80x195 cm PRESTIGE	0314	0296
Lato 90x195 cm PRESTIGE	0315	0297
Lato 100x195 cm PRESTIGE	0316	0298
Lato 120x195 cm PRESTIGE	0317	0299



H195

Altezza

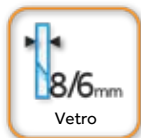

8/6^{mm}

Vetro

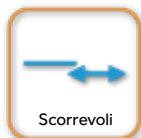

Scorrevoli



3^{cm}

Espandibile



Magnetico



aluminio

AL
aluminium



Reversibile



clear
shield
glass

Cm	Estensibilità	Apert.
70x70	67-70 / 67-70	33
80x70	77-80 / 67-70	37
90x70	87-90 / 67-70	41
100x70	97-100 / 67-70	45
110x70	104-107 / 67-70	47
120x70	117-120 / 67-70	50
130x70	124-127 / 67-70	56
140x70	134-137 / 67-70	60
150x70	144-147 / 67-70	64
160x70	154-157 / 67-70	60
170x70	164-167 / 67-70	64

Cm	Estensibilità	Apert.
70x75	67-70 / 72-74	35
75x75	72-74 / 72-74	37
80x75	77-80 / 72-74	39
90x75	87-90 / 72-74	42
100x75	97-100 / 72-74	47
110x75	104-107 / 72-74	49
120x75	117-120 / 72-74	52
130x75	124-127 / 72-74	58
140x75	134-137 / 72-74	62
150x75	144-147 / 72-74	66
160x75	154-157 / 72-74	62
170x75	164-167 / 72-74	66

Cm	Estensibilità	Apert.
80x80	77-80 / 77-80	40
90x80	87-90 / 77-80	44
100x80	97-100 / 77-80	48
110x80	104-107 / 77-80	50
120x80	117-120 / 77-80	52
130x80	124-127 / 77-80	58
140x80	134-137 / 77-80	62
150x80	144-147 / 77-80	66
160x80	154-157 / 77-80	62
170x80	164-167 / 77-80	66

Cm	Estensibilità	Apert.
90x90	87-90 / 87-90	47
100x90	97-100 / 87-90	51
110x90	104-107 / 87-90	53
120x90	117-120 / 87-90	55
130x90	124-127 / 87-90	60
140x90	134-137 / 87-90	64
150x90	144-147 / 87-90	68
160x90	154-157 / 87-90	64
170x90	164-167 / 87-90	68

TRASPARENTE

Art.
0313 + 0313
0314 + 0313
0315 + 0313
0316 + 0313
0201 + 0313
0317 + 0313
0203 + 0313
0204 + 0313
0205 + 0313
0206 + 0313
0207 + 0313

Art.
0313 + 0375
0375 + 0375
0314 + 0375
0315 + 0375
0316 + 0375
0201 + 0375
0317 + 0375
0203 + 0375
0204 + 0375
0205 + 0375
0206 + 0375
0207 + 0375

Art.
0314 + 0314
0315 + 0314
0316 + 0314
0201 + 0314
0317 + 0314
0203 + 0314
0204 + 0314
0205 + 0314
0206 + 0314
0207 + 0314

Art.
0315 + 0315
0316 + 0315
0201 + 0315
0317 + 0315
0203 + 0315
0204 + 0315
0205 + 0315
0206 + 0315
0207 + 0315

FROST PLUS

Art.
0295 + 0295
0296 + 0295
0297 + 0295
0298 + 0295
0273 + 0295
0299 + 0295
0275 + 0295
0276 + 0295
0277 + 0295
0278 + 0295
0279 + 0295

Art.
0295 + 0294
0294 + 0294
0296 + 0294
0297 + 0294
0298 + 0294
0273 + 0294
0299 + 0294
0275 + 0294
0276 + 0294
0277 + 0294
0278 + 0294
0279 + 0294

Art.
0296 + 0296
0297 + 0296
0298 + 0296
0273 + 0296
0299 + 0296
0275 + 0296
0276 + 0296
0277 + 0296
0278 + 0296
0279 + 0296

Art.
0297 + 0297
0298 + 0297
0273 + 0297
0299 + 0297
0275 + 0297
0276 + 0297
0277 + 0297
0278 + 0297
0279 + 0297

Si possono anche ottenere abbinamenti con lati 100 e 120

Descrizione	Art.
Profilo espansione +2 cm	0218
Profilo espansione +4 cm	0029

PRESTIGE frontale + laterale fisso 8 mm



Descrizione	Estensibilità (min-max)	Art.
Laterale fisso STD 8 mm 30x195	26-29	0810
Laterale fisso STD 8 mm 40x195	36-39	0811
Laterale fisso STD 8 mm 50x195	46-49	0812
Laterale fisso STD 8 mm 60x195	56-59	0813
Laterale fisso STD 8 mm 70x195	66-69	0814
Laterale fisso STD 8 mm 75x195	71-74	0820
Laterale fisso STD 8 mm 80x195	76-79	0815
Laterale fisso STD 8 mm 90x195	86-89	0816
Laterale fisso STD 8 mm FROST PLUS 70	66-69	0817
Laterale fisso STD 8 mm FROST PLUS 80	76-79	0818
Laterale fisso STD 8 mm FROST PLUS 90	86-89	0819

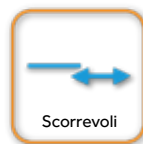

PRESTIGE + laterale fisso 8 mm



Chiusura con magnete occulto



Doppio cuscinetto rinforzato



Pulsante liberatore

Cm	Estensibilità	Apert.	TRASPARENTE	FROST PLUS
			Art.	Art.
100x70	97,4-100,4 / 66-69	38	0200 + 0814	0272 + 0817
110x70	107,4-110,4 / 66-69	43	0201 + 0814	0273 + 0817
120x70	117,4-120,4 / 66-69	48	0202 + 0814	0274 + 0817
130x70	127,4-130,4 / 66-69	53	0203 + 0814	0275 + 0817
140x70	137,4-140,4 / 66-69	58	0204 + 0814	0276 + 0817
150x70	147,4-150,4 / 66-69	53	0205 + 0814	0277 + 0817
160x70	157,4-160,4 / 66-69	58	0206 + 0814	0278 + 0817
170x70	167,4-170,4 / 66-69	63	0207 + 0814	0279 + 0817
Cm	Estensibilità	Apert.	Art.	Art.
100x80	97,4-100,4 / 76-79	38	0200 + 0815	0272 + 0818
110x80	107,4-110,4 / 76-79	43	0201 + 0815	0273 + 0818
120x80	117,4-120,4 / 76-79	48	0202 + 0815	0274 + 0818
130x80	127,4-130,4 / 76-79	53	0203 + 0815	0275 + 0818
140x80	137,4-140,4 / 76-79	58	0204 + 0815	0276 + 0818
150x80	147,4-150,4 / 76-79	53	0205 + 0815	0277 + 0818
160x80	157,4-160,4 / 76-79	58	0206 + 0815	0278 + 0818
170x80	167,4-170,4 / 76-79	63	0207 + 0815	0279 + 0818
Cm	Estensibilità	Apert.	Art.	Art.
100x90	97,4-100,4 / 86-89	38	0200 + 0816	0272 + 0819
110x90	107,4-110,4 / 86-89	43	0201 + 0816	0273 + 0819
120x90	117,4-120,4 / 86-89	48	0202 + 0816	0274 + 0819
130x90	127,4-130,4 / 86-89	53	0203 + 0816	0275 + 0819
140x90	137,4-140,4 / 86-89	58	0204 + 0816	0276 + 0819
150x90	147,4-150,4 / 86-89	53	0205 + 0816	0277 + 0819
160x90	157,4-160,4 / 86-89	58	0206 + 0816	0278 + 0819
170x90	167,4-170,4 / 86-89	63	0207 + 0816	0279 + 0819

*Si possono abbinare misure intermedie di frontali.

Descrizione	Art.
Profilo espansione +2 cm	0218
Profilo espansione +4 cm	0029
Profilo espansione + 5,5 cm	0219



Descrizione	TRASPARENTE	FROST PLUS
	Art.	Art.
Laterali fissi su misura		
Laterale fisso su misura fino 40 cm	1343	1343+1312
Laterale fisso su misura 40 fino 80 cm	1304	1304+1313
Laterale fisso su misura 80 fino 120 cm	1310	1310+1315

*Tempo di consegna 3 settimane (maggiori informazioni a pagina 290)

aktual

“Evoluzione e prestazioni
Prestige senza guida
inferiore”





AKTUAL 1 fisso+1 scorrevole



Descrizione	Estensibilità	Apertura	TRASPARENTE	FROST PLUS
			Art.	Art.
AKTUAL 1F+1S 100X195	97-103	38	0280	0580
AKTUAL 1F+1S 110X195	107-113	43	0281	0581
AKTUAL 1F+1S 120X195	117-123	48	0282	0582
AKTUAL 1F+1S 130X195	127-133	53	0283	0583
AKTUAL 1F+1S 140X195	137-143	58	0284	0584
AKTUAL 1F+1S 150X195	147-153	63	0285	0585
AKTUAL 1F+1S 160X195	157-163	58	0286	0586
AKTUAL 1F+1S 170X195	167-173	63	0287	0587
Profilo espansione +2 cm				0218
Profilo espansione +4 cm				0029

*Si può abbinare al Laterale Fisso STD (vedi pag. 114), l'estensibilità aumenta di 0,7 e si perde l'espansione nel lato in cui si installa il fisso.

AKTUAL 2 fissi+2 scorrevoli

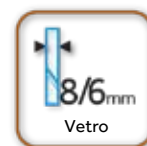

PREST/AKT

Descrizione	Estensibilità	Apertura	TRASPARENTE	FROST PLUS
			Art.	Art.
AKTUAL 2F+2S 140X195	136-142	53	0570	0588
AKTUAL 2F+2S 150X195	146-152	58	0571	0589
AKTUAL 2F+2S 160X195	156-162	63	0572	0590
AKTUAL 2F+2S 170X195	166-172	68	0573	0591
AKTUAL 2F+2S 180X195	176-182	73	0574	0592
AKTUAL 2F+2S 190X195	186-192	78	0575	0593
Profilo espansione +2 cm				0218
Profilo espansione +4 cm				0029

*Se puede combinar con el lateral fijo STD (vedi pag. 114), l'estensibilitat augmenta de 0,7 e si perd l'espansione nel lato in cui si installa il fijo.

AKTUAL apertura angolare



Descrizione	TRASPARENTE	FROST PLUS
	Art.	Art.
Lato 70 x195 AKTUAL 1 fisso+1 scorrevole	0320	0595
Lato 80 x195 AKTUAL 1 fisso+1 scorrevole	0321	0596
Lato 90 x195 AKTUAL 1 fisso+1 scorrevole	0322	0597
Lato 100 x195 AKTUAL 1 fisso+1 scorrevole	0323	0598
Lato 120 x195 AKTUAL 1 fisso+1 scorrevole	0324	0599



H195

Altezza



8/6mm

Vetro

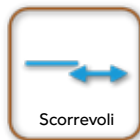

Scorrevoli



3cm

Espandibile



Magnetico



Reversibile



aluminio
AL
aluminium



clear shield glass

combinazioni **AKTUAL** apertura angolare



Maniglia metallica



Doppio cuscinetto anti-ribaltamento



Profilo salva goccia metallico

Cm	Estensibilità	Apert.
70x70	67-70 / 67-70	33
80x70	77-80 / 67-70	37
90x70	87-90 / 67-70	41
100x70	97-100 / 67-70	45
110x70	104-107 / 67-70	47
120x70	117-120 / 67-70	50
130x70	124-127 / 67-70	56
140x70	134-137 / 67-70	60
150x70	144-147 / 67-70	64

Cm	Estensibilità	Apert.
80x80	77-80 / 77-80	40
90x80	87-90 / 77-80	44
100x80	97-100 / 77-80	48
110x80	104-107 / 77-80	50
120x80	117-120 / 77-80	52
130x80	124-127 / 77-80	58
140x80	134-137 / 77-80	62
150x80	144-147 / 77-80	66

Cm	Estensibilità	Apert.
90x90	87-90 / 87-90	47
100x90	97-100 / 87-90	51
110x90	104-107 / 87-90	53
120x90	117-120 / 87-90	55
130x90	124-127 / 87-90	60
140x90	134-137 / 87-90	64
150x90	144-147 / 87-90	68

TRASPARENTE	FROST PLUS
Art.	Art.
0320 + 0320	0595 + 0595
0321 + 0320	0596 + 0595
0322 + 0320	0597 + 0595
0323 + 0320	0598 + 0595
0281 + 0320	0581 + 0595
0324 + 0320	0599 + 0595
0283 + 0320	0583 + 0595
0284 + 0320	0584 + 0595
0285 + 0320	0585 + 0595
Art.	Art.
0321 + 0321	0596 + 0596
0322 + 0321	0597 + 0596
0323 + 0321	0598 + 0596
0281 + 0321	0581 + 0596
0324 + 0321	0599 + 0596
0283 + 0321	0583 + 0596
0284 + 0321	0584 + 0596
0285 + 0321	0585 + 0596
Art.	Art.
0322 + 0322	0597 + 0597
0323 + 0322	0598 + 0597
0281 + 0322	0581 + 0597
0324 + 0322	0599 + 0597
0283 + 0322	0583 + 0597
0284 + 0322	0584 + 0597
0285 + 0322	0585 + 0597

Si possono anche ottenere abbinamenti con lati 100 e 120

Descrizione	Art.
Profilo espansione +2 cm	0218
Profilo espansione +4 cm	0029

PREST/AKT

AKTUAL frontale + laterale fisso STD 8 mm



Descrizione	Estensibilità (min-max)	Art.
Laterale fisso STD 8 mm 30	26-29	0810
Laterale fisso STD 8 mm 40	36-39	0811
Laterale fisso STD 8 mm 50	46-49	0812
Laterale fisso STD 8 mm 60	56-59	0813
Laterale fisso STD 8 mm 70	66-69	0814
Laterale fisso STD 8 mm 75	71-74	0820
Laterale fisso STD 8 mm 80	76-79	0815
Laterale fisso STD 8 mm 90	86-89	0816
Laterale fisso STD 8 mm FROST PLUS 70	66-69	0817
Laterale fisso STD 8 mm FROST PLUS 80	76-79	0818
Laterale fisso STD 8 mm FROST PLUS 90	86-89	0819



H195

Altezza



8/6mm

Vetro

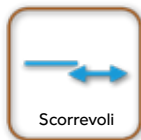

Scorrevoli



3cm

Espandibile



Magnetico



Reversibile



aluminio
AL
aluminium



clear
shield
glass



Chiusura con magneti occulti



Doppio cuscinetto anti-ribaltamento



Profilo salva goccia metallico

AKTUAL + laterale fisso 8 mm

Cm	Estensibilità	Apert.	TRASPARENTE	FROST PLUS
			Art.	Art.
100x70	97,4-100,4 / 66-69	38	0280 + 0814	0580 + 0817
110x70	107,4-110,4 / 66-69	43	0281 + 0814	0581 + 0817
120x70	117,4-120,4 / 66-69	48	0282 + 0814	0582 + 0817
130x70	127,4-130,4 / 66-69	53	0283 + 0814	0583 + 0817
140x70	137,4-140,4 / 66-69	58	0284 + 0814	0584 + 0817
150x70	147,4-150,4 / 66-69	53	0285 + 0814	0585 + 0817
160x70	157,4-160,4 / 66-69	58	0286 + 0814	0586 + 0817
170x70	167,4-170,4 / 66-69	63	0287 + 0814	0587 + 0817
100x80	97,4-100,4 / 76-79	38	0280 + 0815	0580 + 0818
110x80	107,4-110,4 / 76-79	43	0281 + 0815	0581 + 0818
120x80	117,4-120,4 / 76-79	48	0282 + 0815	0582 + 0818
130x80	127,4-130,4 / 76-79	53	0283 + 0815	0583 + 0818
140x80	137,4-140,4 / 76-79	58	0284 + 0815	0584 + 0818
150x80	147,4-150,4 / 76-79	53	0285 + 0815	0585 + 0818
160x80	157,4-160,4 / 76-79	58	0286 + 0815	0586 + 0818
170x80	167,4-170,4 / 76-79	63	0287 + 0815	0587 + 0818
100x90	97,4-100,4 / 86-89	38	0280 + 0816	0580 + 0819
110x90	107,4-110,4 / 86-89	43	0281 + 0816	0581 + 0819
120x90	117,4-120,4 / 86-89	48	0282 + 0816	0582 + 0819
130x90	127,4-130,4 / 86-89	53	0283 + 0816	0583 + 0819
140x90	137,4-140,4 / 86-89	58	0284 + 0816	0584 + 0819
150x90	147,4-150,4 / 86-89	53	0285 + 0816	0585 + 0819
160x90	157,4-160,4 / 86-89	58	0286 + 0816	0586 + 0819
170x90	167,4-170,4 / 86-89	63	0287 + 0816	0587 + 0819

*Si possono abbinare misure intermedie di frontali

Descrizione	Art.
Profilo espansione +2 cm	0218
Profilo espansione +4 cm	0029
Profilo espansione + 5,5 cm	0219



Lati fissi su misura AKTUAL	TRASPARENTE	FROST PLUS
	Art.	Art.
Laterale fisso su misura fino 40 cm	1343	1343+1312
Laterale fisso su misura da 40 fino 80 cm	1304	1304+1313
Laterale fisso su misura da 80 fino 120 cm	1310	1310+1315

*Tempo di consegna 3 settimane. Maggiori informazioni a pagina 290.

GME

VETRUM pg.119



TEMPLE pg.129



FUTURA pg.133

MOVING pg.137

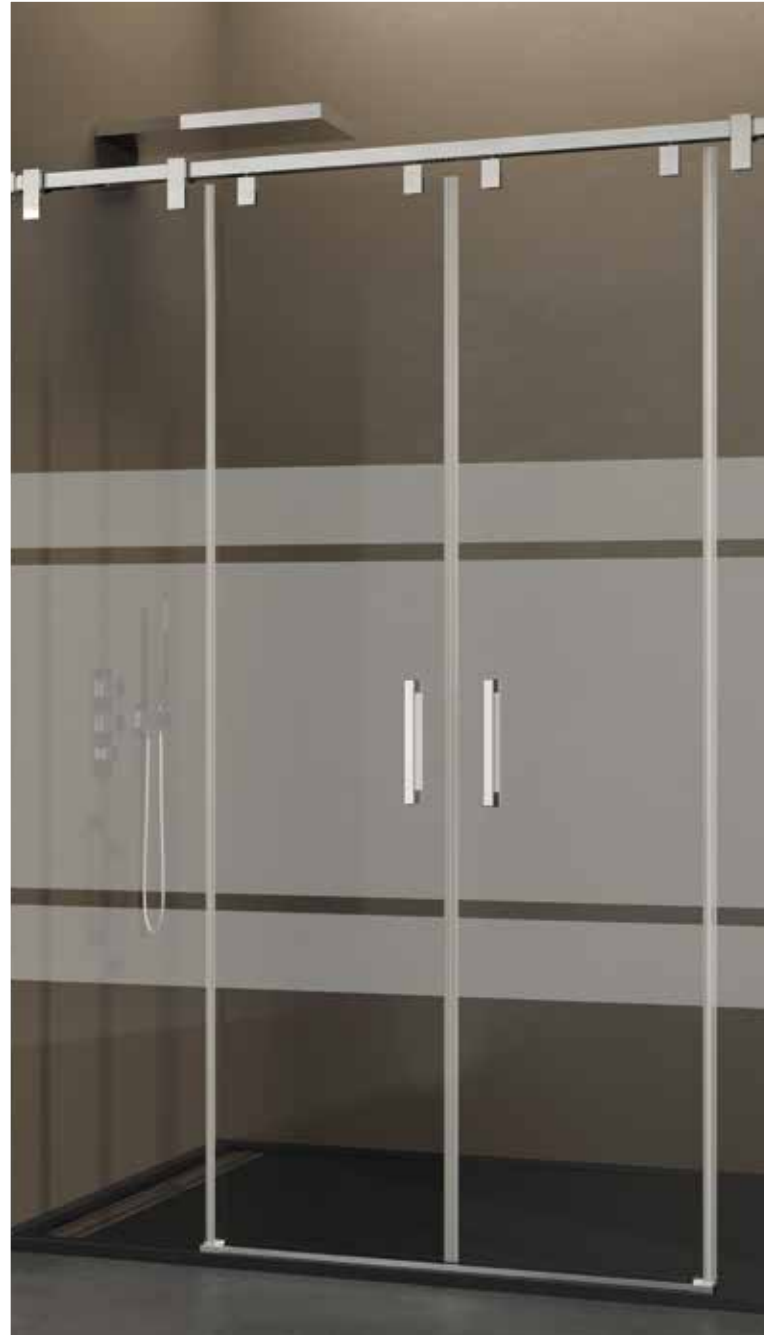

ACCIAIO

**CABINE DOCCIA
ACCIAIO
SCORREVOLI**

vetrum

10/8mm

“Design e qualità insuperabili
con totale assenza di profili”





ACCIAIO

VETRUM 1 fisso + 1 scorrevole



**H202**

Altezza

1-6
cm

Incrocio

10/8
mm

Vetro

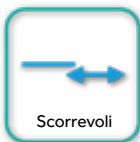

Scorrevoli



Magnetico



Reversibile

**STAINLESS
INOX
STEEL**Trattamento anticalcare
CLEAR
SHIELD
GLASS

Frontali VETRUM 1 fisso+1 scorrevole

Descrizione	Estensibilità	Apertura	Art.
Frontale doccia 1F+1S VETRUM 115	113-118	39,7-44,3	1070
Frontale doccia 1F+1S VETRUM 120	117-122	40,7-45,7	1050
Frontale doccia 1F+1S VETRUM 125	122-127	40,7-45,7	1051
Frontale doccia 1F+1S VETRUM 130	127-132	45,7-50,7	1052
Frontale doccia 1F+1S VETRUM 135	132-137	45,7-50,7	1053
Frontale doccia 1F+1S VETRUM 140	137-142	50,7-55,7	1054
Frontale doccia 1F+1S VETRUM 145	142-147	50,7-55,7	1055
Frontale doccia 1F+1S VETRUM 150	147-152	55,7-60,7	1056
Frontale doccia 1F+1S VETRUM 155	152-157	55,7-60,7	1057
Frontale doccia 1F+1S VETRUM 160	157-162	60,7-65,7	1058
Frontale doccia 1F+1S VETRUM 165	162-167	60,7-65,7	1059
Frontale doccia 1F+1S VETRUM 170	167-172	65,7-70,7	1060
Frontale doccia 1F+1S VETRUM 175	172-177	60,7-65,7	1061
Frontale doccia 1F+1S VETRUM 180	177-182	65,7-70,7	1062
Profilo espansione +1 cm			1073
Opzione barra inox parallela fino 2 m			5546
Possibilità chiusura profilo inox + guarnizione a bolle *Con questo sistema l'estensibilità diminuisce di 2 cm			1072



Guida e cuscinetto inferiore in acciaio



Cuscinetto acciaio integrato



Opzione barra parallela



VETRUM FREE 1 fisso + 1 scorrevole

Descrizione	Art.
Freno vetrum free	1071

Nel formato Free l'estensibilità si riduce di 2 cm

VETRUM 2 fissi + 2 scorrevoli



Descrizione

Art.

Kit di trasformazione 2f+2c

1071

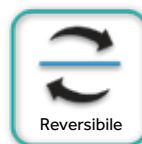
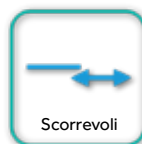

Frontali VETRUM 2F + 2C

Descrizione	Estensibilità	Apertura	Art.
VETRUM 2F + 2C 150	134-154	30-50	1067+1067+1071
VETRUM 2F + 2C 170	154-174	40-60	1068+1068+1071
VETRUM 2F + 2C 190	174-194	50-70	1069+1069+1071
VETRUM 2F + 2C 210	213-233	69-89	1070+1070+1071
Profilo espansione +1 cm			1073



Guida e cuscinetto inferiore in acciaio



Cuscinetto acciaio integrato



Barra acciaio est. 108 cm ed orientabile

VETRUM apertura angolare



Descrizione	Art.
Lato VETRUM 70 1 fisso+1 scorrevole	1066
Lato VETRUM 80 1 fisso+1 scorrevole	1067
Lato VETRUM 90 1 fisso+1 scorrevole	1068
Lato VETRUM 100 1 fisso+1 scorrevole	1069
Lato VETRUM 120 1 fisso+1 scorrevole	1070



H202

Altezza

1-6
cm

Incrocio

10/8
mm

Vetro

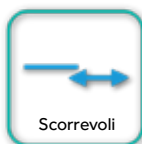

Scorrevoli



Magnetico



Reversibile

STAINLESS
INOX
STEELTrattamento anticalcare
clear
shield
glass

Combinazioni VETRUM apertura angolare

Cm	Estensibilità	Apertura	Art.
90x70	85-90/65-70	33-36	1068+1066
100x70	95-100/65-70	37-40	1069+1066
115x70	114-119/65-70	44-49	1070+1066
120x70	118-123/65-70	44-49	1050+1066
125x70	123-128/65-70	45-50	1051+1066
130x70	128-133/65-70	49-54	1052+1066
135x70	133-138/65-70	49-54	1053+1066
140x70	138-143/65-70	55-60	1054+1066
145x70	143-148/65-70	55-60	1055+1066
150x70	148-153/65-70	59-64	1056+1066
Cm	Estensibilità	Apertura	Art.
80x80	75-80/75-80	33-36	1067+1067
90x80	85-90/75-80	36-39	1068+1067
100x80	95-100/75-80	40-43	1069+1067
115x80	114-119/75-80	46-51	1070+1067
120x80	118-123/75-80	46-51	1050+1067
125x80	123-128/75-80	47-52	1051+1067
130x80	128-133/75-80	51-56	1052+1067
135x80	133-138/75-80	51-56	1053+1067
140x80	138-143/75-80	56-61	1054+1067
145x80	143-148/75-80	56-61	1055+1067
150x80	148-153/75-80	60-65	1056+1067
Cm	Estensibilità	Apertura	Art.
90x90	85-90/85-90	40-43	1068+1068
100x90	95-100/85-90	43-46	1069+1068
115x90	114-119/85-90	51-54	1070+1068
120x90	118-123/85-90	51-54	1050+1068
125x90	123-128/85-90	50-55	1051+1068
130x90	128-133/85-90	54-59	1052+1068
135x90	133-138/85-90	54-59	1053+1068
140x90	138-143/85-90	58-63	1054+1068
145x90	143-148/85-90	58-63	1055+1068
150x90	148-153/85-90	63-68	1056+1068
Profilo espansione +1 cm			1073

VETRUM frontale + laterale fisso



Descrizione	Estensibilità	Art.
Laterale fisso 70 VETRUM 10 mm + braccetto	67-69	1063
Laterale fisso 75 VETRUM 10 mm + braccetto	72-74	1115
Laterale fisso 80 VETRUM 10 mm + braccetto	77-79	1064
Laterale fisso 90 VETRUM 10 mm + braccetto	87-89	1065

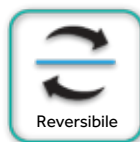
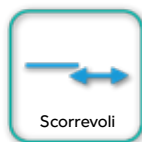

Combinazioni VETRUM frontale + laterale fisso

Cm	Estensibilità	Art.	Cm	Estensibilità	Art.
115x70	113-117 / 67-69	1070 + 1063	115x75	113-117 / 72-74	1070 + 1115
120x70	116-121 / 67-69	1050 + 1063	120x75	116-121 / 72-74	1050 + 1115
125x70	121-126 / 67-69	1051 + 1063	125x75	121-126 / 72-74	1051 + 1115
130x70	126-131 / 67-69	1052 + 1063	130x75	126-131 / 72-74	1052 + 1115
135x70	131-136 / 67-69	1053 + 1063	135x75	131-136 / 72-74	1053 + 1115
140x70	136-141 / 67-69	1054 + 1063	140x75	136-141 / 72-74	1054 + 1115
145x70	141-146 / 67-69	1055 + 1063	145x75	141-146 / 72-74	1055 + 1115
150x70	146-151 / 67-69	1056 + 1063	150x75	146-151 / 72-74	1056 + 1115
155x70	151-156 / 67-69	1057 + 1063	155x75	151-156 / 72-74	1057 + 1115
160x70	156-161 / 67-69	1058 + 1063	160x75	156-161 / 72-74	1058 + 1115
165x70	161-166 / 67-69	1059 + 1063	165x75	161-166 / 72-74	1059 + 1115
170x70	166-171 / 67-69	1060 + 1063	170x75	166-171 / 72-74	1060 + 1115
175x70	171-176 / 67-69	1061 + 1063	175x75	171-176 / 72-74	1061 + 1115
180x70	176-181 / 67-69	1062 + 1063	180x75	176-181 / 72-74	1062 + 1115
Cm	Estensibilità	Art.	Cm	Estensibilità	Art.
115x80	113-117 / 77-79	1070 + 1064	115x90	113-117 / 87-89	1070 + 1065
120x80	116-121 / 77-79	1050 + 1064	120x90	116-121 / 87-89	1050 + 1065
125x80	121-126 / 77-79	1051 + 1064	125x90	121-126 / 87-89	1051 + 1065
130x80	126-131 / 77-79	1052 + 1064	130x90	126-131 / 87-89	1052 + 1065
135x80	131-136 / 77-79	1053 + 1064	135x90	131-136 / 87-89	1053 + 1065
140x80	136-141 / 77-79	1054 + 1064	140x90	136-141 / 87-89	1054 + 1065
145x80	141-146 / 77-79	1055 + 1064	145x90	141-146 / 87-89	1055 + 1065
150x80	146-151 / 77-79	1056 + 1064	150x90	146-151 / 87-89	1056 + 1065
155x80	151-156 / 77-79	1057 + 1064	155x90	151-156 / 87-89	1057 + 1065
160x80	156-161 / 77-79	1058 + 1064	160x90	156-161 / 87-89	1058 + 1065
165x80	161-166 / 77-79	1059 + 1064	165x90	161-166 / 87-89	1059 + 1065
170x80	166-171 / 77-79	1060 + 1064	170x90	166-171 / 87-89	1060 + 1065
175x80	171-176 / 77-79	1061 + 1064	175x90	171-176 / 87-89	1061 + 1065
180x80	176-181 / 77-79	1062 + 1064	180x90	176-181 / 87-89	1062 + 1065
1073	Profilo espansione +1 cm				

ACCIAIO

*Le aperture sono le stesse dei frontali.

Laterali fissi su misura (maggiori informazioni a pagina 290)



Descrizione	Art.
Laterale fisso su misura VETRUM fino 40 cm	1340
Laterale fisso su misura VETRUM da 40 fino 80 cm	1300
Laterale fisso su misura VETRUM da 80 fino 120 cm	1306
Profilo di unione fisso + laterale fisso (vedi pag. 295)	1075

*Tempo di consegna 3 settimane

temple

“La nobiltà e la forza
dell'acciaio alestensibilità di
tutti”





ACCIAIO



TEMPLE

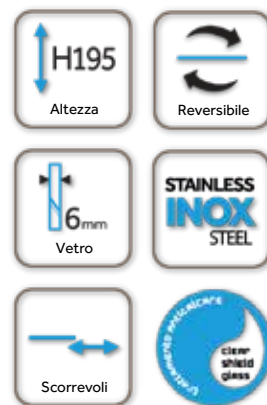

Abbellimenti. Finiture esterne e interne perfette.



Nylon a doppio cuscinetto di ultima generazione



Guida innovativa con sgancio della lama a pulsante per una facile pulizia



Profilo in acciaio inox con guida interna in alluminio



CABINE DOCCIA SU MISURA E VETRI SPECIALI

Tempo di consegna 3 settimane (maggiori informazioni pag. 288)

LATI FISSI SU MISURA
Tempo di consegna 3 settimane (maggiori informazioni pag. 290)

Descrizione	TRASPARENTE	FROST PLUS
	Art.	Art.
Lato TEMPLE 70 1 fisso+1 scorrevole	5118	6118
Lato TEMPLE 75 1 fisso+1 scorrevole	5129	6129
Lato TEMPLE 80 1 fisso+1 scorrevole	5119	6119
Lato TEMPLE 90 1 fisso+1 scorrevole	5120	6120
Lato TEMPLE 100 1 fisso+1 scorrevole	5121	6121
Lato TEMPLE 120 1 fisso+1 scorrevole	5122	6122
Kit unione angolare lato+lato	5123	
Kit unione angolare frontale+lato	5124	

TEMPLE apertura angolare

Cm	Estensibilità	TRASPARENTE	FROST PLUS
		Art.	Art.
70x70	65-70 / 65-70	5118+5118+5123	6118+6118+5123
75x70	70-75 / 65-70	5129+5118+5123	6129+6118+5123
80x70	75-80 / 65-70	5119+5118+5123	6119+6118+5123
90x70	85-90 / 65-70	5120+5118+5123	6120+6118+5123
100x70	95-100 / 65-70	5121+5118+5123	6121+6118+5123
120x70	115-120 / 65-70	5122+5118+5123	6122+6118+5123
75x80	70-75 / 75-80	5119+5129+5123	6119+6129+5123
80x80	75-80 / 75-80	5119+5119+5123	6119+6119+5123
90x80	85-90 / 75-80	5120+5119+5123	6120+6119+5123
100x80	95-100 / 75-80	5121+5119+5123	6121+6119+5123
120x80	115-120 / 75-80	5122+5119+5123	6122+6119+5123
90x90	85-90 / 85-90	5120+5120+5123	6120+6120+5123
100x90	95-100 / 85-90	5121+5120+5123	6121+6120+5123
120x90	115-120 / 85-90	5122+5120+5123	6122+6120+5123



ACCIAIO

Frontali TEMPLE 1 fisso+1 scorrevole

Cm	TRASPARENTE	FROST PLUS
	Art.	Art.
95-100	5101	6101
100-105	5102	6102
105-110	5103	6103
110-115	5104	6104
115-120	5105	6105
120-125	5106	6106
125-130	5107	6107
130-135	5108	6108
135-140	5109	6109
140-145	5110	6110
145-150	5111	6111
150-155	5112	6112
155-160	5113	6113
160-165	5114	6114
165-170	5115	6115
*170-180	5117	6117

*Le aperture sono le stesse delle combinazioni del modello Basic a pagina 61.

Descrizione	Art.
Profilo espansione +1,5 cm	5179
Adorno in alluminio 193,7x3,4 cm	0008

Laterali fissi TEMPLE

Estensibilità	TRASPARENTE	FROST PLUS
	Art.	Art.
66,5-69	5125	6125
71,5-74	5157	6157
76,5-79	5126	6126
86,5-89	5127	6127

Combinazioni TEMPLE + laterale fisso

Estensibilità	TRASPARENTE	FROST PLUS
	Art.	Art.
95-100/66,5-69	5101+5125	6101+6125
105-110/66,5-69	5103+5125	6103+6125
115-120/66,5-69	5105+5125	6105+6125
125-130/66,5-69	5107+5125	6107+6125
135-140/66,5-69	5109+5125	6109+6125
145-150/66,5-69	5111+5125	6111+6125
155-160/66,5-69	5113+5125	6113+6125
165-170/66,5-69	5115+5125	6115+6125
170-180/66,5-69	5117+5125	6117+6125
95-100/76,5-79	5101+5126	6101+6126
105-110/76,5-79	5103+5126	6103+6126
115-120/76,5-79	5105+5126	6105+6126
125-130/76,5-79	5107+5126	6107+6126
135-140/76,5-79	5109+5126	6109+6126
145-150/76,5-79	5111+5126	6111+6126
155-160/76,5-79	5113+5126	6113+6126
165-170/76,5-79	5115+5126	6115+6126
170-180/76,5-79	5117+5126	6117+6126

Profilo di unione fisso-fisso **1075**

Si possono abbinare misure intermedie di frontali

*Porta incrocio 1-11 cm

futura

“Combinazione di barra
d'acciaio e cuscinetti a
scomparsa con stile proprio”





ACCIAIO

FUTURA



frontali 1 fisso + 1 scorrevole FUTURA

Estensibilità	TRASPARENTE	FROST PLUS
	Art.	Art.
95-100	5301	6301
100-105	5302	6302
105-110	5303	6303
110-115	5304	6304
115-120	5305	6305
120-125	5306	6306
125-130	5307	6307
130-135	5308	6308
135-140	5309	6309
140-145	5310	6310
145-150	5311	6311
150-155	5312	6312
155-160	5313	6313
160-165	5314	6314
165-170	5315	6315
170-175	5316	6316
175-180	5317	6317

Descrizione	Art.
Profilo espansione +1,5 cm	5179
Adorno in acciaio 193,7x3,4 cm	0008



frontali 2 fissi + 2 scorrevoli FUTURA

Estensibilità	TRASPARENTE	FROST PLUS
	Art.	Art.
132-142	5029x2+5351	6029x2+5351
142-152	5019x2+5351	6019x2+5351
152-162	5030x2+5351	6030x2+5351
162-172	5020x2+5351	6020x2+5351
172-182	5031x2+5354	6031x2+5354
182-192	5021x2+5354	6021x2+5354
190-200	5001x2+5354	6001x2+5354
200-210	5002x2+5354	6002x2+5354

*Le aperture sono le stesse delle combinazioni del modello Basic a pagina 61.



Profilo ed accessori in acciaio inossidabile



CABINE DOCCIA SU MISURA E VETRI SPECIALI

Tempo di consegna 3 settimane (maggiori informazioni pag. 288)

LATI FISSI SU MISURA

Tempo di consegna 3 settimane (maggiori informazioni pag. 290)



ACCIAIO

Lati FUTURA	TRASPARENTE	FROST PLUS
Descrizione	Art.	Art.
Lato FUTURA 70	5018	6018
Lato FUTURA 75	5029	6029
Lato FUTURA 80	5019	6019
Lato FUTURA 90	5020	6020
Lato FUTURA 100	5021	6021
Lato FUTURA 120	5022	6022
kit angolare 120x90	5323	

FUTURA apertura angolare

Estensibilità	TRASPARENTE Art.	FROST PLUS Art.
65-70/65-70	5018+5018+5323	6018+6018+5323
70-75/65-70	5029+5018+5323	6029+6018+5323
75-80/65-70	5019+5018+5323	6019+6018+5323
85-90/65-70	5020+5018+5323	6020+6018+5323
95-100/65-70	5021+5018+5323	6021+6018+5323
115-120/65-70	5022+5018+5323	6022+6018+5323
75-80/75-80	5019+5019+5323	6019+6019+5323
85-90/75-80	5020+5019+5323	6020+6019+5323
95-100/75-80	5021+5019+5323	6021+6019+5323
115-120/75-80	5022+5019+5323	6022+6019+5323
85-90/85-90	5020+5020+5323	6020+6020+5323
95-100/85-90	5021+5020+5323	6021+6020+5323
115-120/85-90	5022+5020+5323	6022+6020+5323

laterali fissi FUTURA 8 mm

Estensibilità	TRASPARENTE	FROST PLUS
	Art.	Art.
66,5 - 69	5325	6325
71,5 - 74	5357	6357
76,5 - 79	5326	6326
86,5 - 89	5327	6327

combinazioni FUTURA + laterale fisso

Estensibilità	TRASPARENTE	FROST PLUS
	Art.	Art.
95-100/66,5-69	5301+5325	6301+6325
105-110/66,5-69	5303+5325	6303+6325
115-120/66,5-69	5305+5325	6305+6325
125-130/66,5-69	5307+5325	6307+6325
135-140/66,5-69	5309+5325	6309+6325
145-150/66,5-69	5311+5325	6311+6325
155-160/66,5-69	5313+5325	6313+6325
165-170/66,5-69	5315+5325	6315+6325
175-180/66,5-69	5317+5325	6317+6325
95-100/76,5-79	5301+5326	6301+6326
105-110/76,5-79	5303+5326	6303+6326
115-120/76,5-79	5305+5326	6305+6326
125-130/76,5-79	5307+5326	6307+6326
135-140/76,5-79	5309+5326	6309+6326
145-150/76,5-79	5311+5326	6311+6326
155-160/76,5-79	5313+5326	6313+6326
165-170/76,5-79	5315+5326	6315+6326
175-180/76,5-79	5317+5326	6317+6326

Per altre combinazioni con dimensioni intermedie dei pannelli frontali e con pannelli fissi 75/90, utilizzare il Art./estensibilità/P.

moving 8mm

“Design classico ed elegante
in acciaio per i clienti più
esigenti”





ACCIAIO



Profilo inox



Guida e profilo salva goccia in acciaio



Barra e profilo inox

Frontali MOVING 1 fisso + 1 scorrevole

Descrizione	Apert.	Estensibilità	Art.
Frontale MOVING 1F+1S 115	42-47	112 - 117	1104
Frontale MOVING 1F+1S 120	47-52	117 - 122	1005
Frontale MOVING 1F+1S 125	52-57	122 - 127	1105
Frontale MOVING 1F+1S 130	47-52	127 - 132	1006
Frontale MOVING 1F+1S 135	52-57	132 - 137	1106
Frontale MOVING 1F+1S 140	57-62	137 - 142	1007
Frontale MOVING 1F+1S 145	52-57	142 - 147	1107
Frontale MOVING 1F+1S 150	57-62	147 - 152	1008
Frontale MOVING 1F+1S 155	57-62	152 - 157	1108
Frontale MOVING 1F+1S 160	62-67	157 - 162	1009
Frontale MOVING 1F+1S 165	67-72	162 - 167	1109
Frontale MOVING 1F+1S 170	62-67	167 - 172	1010
Frontale MOVING 1F+1S 175	67-72	172 - 177	1110
Frontale MOVING 1F+1S 180	67-72	177 - 182	1011
Profilo espansione (+1cm)			1074
Opzione chiusura profilo + guarnizione a palloncino *Con questo sistema l'estensibilità diminuisce di 2 cm			1072



ACCIAIO

Lati MOVING

Descrizione	Art.
Lato MOVING 80 1F+1S	1001
Lato MOVING 90 1F+1S	1002
Lato MOVING 120 1F+1S	1104
Kit di trasformazione apertura angolare	1017

Combinazioni MOVING apertura angolare

Cm	Ap.	Estensibilit�	Art.
80x80	41 - 43	76-80/76-80	1001+1001+1017
90x80	45 - 47	86-90/76-80	1002+1001+1017
120x80	52 - 54	116-122/76-80	1104+1001+1017
130x80	60 - 62	124-129/76-80	1105+1001+1017
140x80	60 - 62	134-139/76-80	1106+1001+1017
90x90	48 - 50	86-90/86-90	1002+1002+1017
120x90	55 - 57	116-122/86-90	1104+1002+1017
130x90	63 - 65	124-129/86-90	1105+1002+1017
140x90	63 - 65	134-139/86-90	1106+1002+1017
Profilo espansione +1cm			1074

*Si possono anche abbinare i frontali con misure intermedie.
*L'estensibilit  aumenta 2 cm rispetto al formato frontale.

Laterali fissi MOVING

Descrizione	Cm	Art.
Laterale fisso MOVING 70	67 - 69	1015
Laterale fisso MOVING 80	77 - 79	1016

Combinazioni MOVING + laterale fisso 8 mm

Cm	Estensibilit�	Art.
120X70	116-120/67-69	1005+1015
130X70	126-130/67-69	1006+1015
140X70	136-140/67-69	1007+1015
150X70	146-150/67-69	1008+1015
160X70	156-160/67-69	1009+1015
170X70	166-170/67-69	1010+1015
180X70	176-180/67-69	1011+1015
120X80	116-120/77-79	1005+1016
130X80	126-130/77-79	1006+1016
140X80	136-140/77-79	1007+1016
150X80	146-150/77-79	1008+1016
160X80	156-160/77-79	1009+1016
170X80	166-170/77-79	1010+1016
180x80	176-180/77-79	1011+1016
Profilo espansione +1cm		1074

screen

8mm

“Semplicità e bellezza con un'ampia gamma di opzioni e colori”

-  143 CROMO
-  145 NERO
-  147 BIANCO
-  149 ORO
-  151 RAME
-  153 NICHEL
-  155 TITANIO
-  157 BLACK SCACCHI





SCREEN

SC90CR



	TRASPARENTE	FROST PLUS
Descrizione	Art.	Art.
Screen Cromo da 66,5-68 cm + braccetto supporto	SC70CR	SC70FCR
Screen Cromo da 76,5-78 cm + braccetto supporto	SC80CR	SC80FCR
Screen Cromo da 86,5-88 cm + braccetto supporto	SC90CR	SC90FCR
Screen Cromo da 96,5-98 cm + braccetto supporto	SC100CR	SC100FCR
Screen Cromo da 106,5-108 cm + braccetto supporto	SC110CR	SC110FCR
Screen Cromo da 116,5-118 cm + braccetto supporto	SC120CR	SC120FCR

*Incluso braccio girevole/regolabile 60-120 cm (art. 0184). Opzione barra parallela vedi pag. 159

SCREEN SU MISURA (vedi pag. 292)

	TRASPARENTE	FROST PLUS
Descrizione	Art.	Art.
Larghezza < 80 cm Altezza fino 195 cm	1305	1305+1313
Larghezza 80 a 120 cm Altezza fino 195 cm	1311	1311+1315

Tempo di consegna 3 settimane. Include vetro su misura e kit profilo + braccetto.

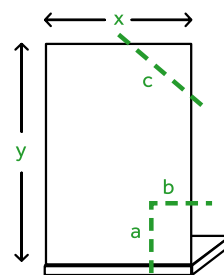

**QUADRATO/TAGLIO
PER VETRO SU MISURA**
Art.: 0862

SCREEN MOVING

SC90FCR+0193

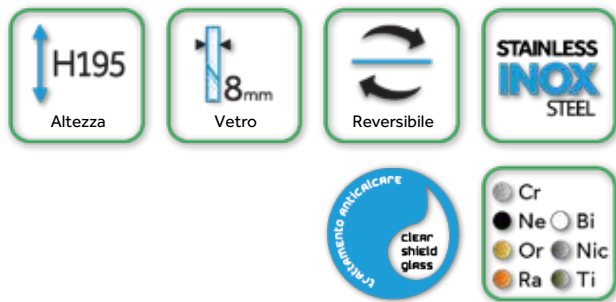

	TRASPARENTE	FROST PLUS
Descrizione	Art.	Art.
Cr. mobile 25 cm	0153	0193
Cr. mobile 40 cm	0154	0194

Il vetro mobile aumenta 24,5 / 39,5 cm la misura dei fissi

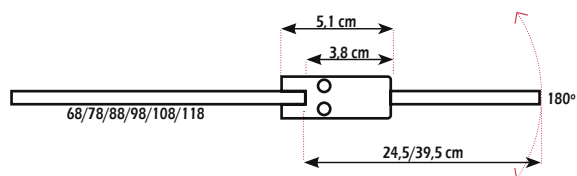

FISSI

SCREEN 35 CERNIERA 180°

SC90CR+0331



Cerniera ottone cromato

	TRASPARENTE	FROST PLUS
Descrizione	Art.	Art.
Cr. mobile 35 cm	0331	0332CR

*Cerniera su misura (vedi pagina 293).

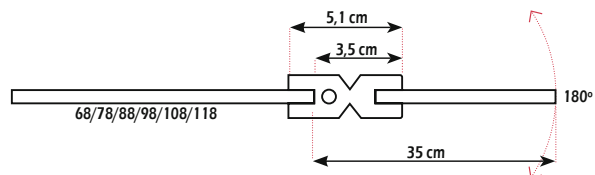

SCREEN NERA



Descrizione	TRASPARENTE	FROST PLUS
	Art.	Art.
Screen nera da 66,5-68 cm + braccetto supporto nero	SC70N	SC70FN
Screen nera da 76,5-78 cm + braccetto supporto nero	SC80N	SC80FN
Screen nera da 86,5-88 cm + braccetto supporto nero	SC90N	SC90FN
Screen nera da 96,5-98 cm + braccetto supporto nero	SC100N	SC100FN
Screen nera da 106,5-108 cm + braccetto supporto nero	SC110N	SC110FN
Screen nera da 116,5-118 cm + braccetto supporto nero	SC120N	SC120FN

*Incluso braccio girevole/regolabile 60-120 cm (art. 0990). Opzione barra parallela vedi pag. 159

SCREEN NERA SU MISURA (vedi pag. 292)

Descrizione	TRASPARENTE	FROST PLUS
	Art.	Art.
Larghezza < 80 cm Altezza fino 195 cm	1305N	1305N+1313
Larghezza 80 a 120 cm Altezza fino 195 cm	1311N	1311N+1315

Tempo di consegna 3 settimane

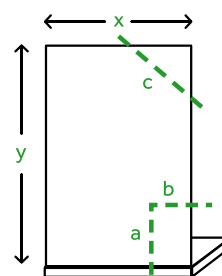

**QUADRATO/TAGLIO
PER VETRO SU MISURA**

Art.: 0862

SCREEN NERA cerniera mobile 180°



FISSI

	TRASPARENTE	FROST PLUS
Descrizione	Art.	Art.
Cr. mobile di 35 cm	0331N	0332N

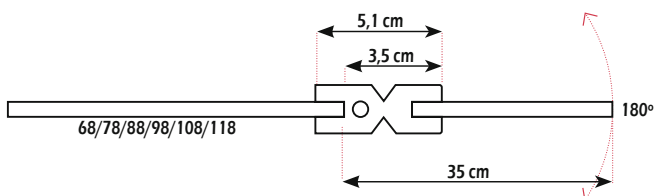

CERNIERE MOBILI NERO SU MISURA (vedi pag. 293)

	TRASPARENTE	FROST PLUS
Cm	Art.	Art.
Larghezza < 40 cm Altezza fino 195 cm	1355N	1357N
Larghezza 40 a 80 cm Altezza fino 195 cm	1356N	1358N

Tempo di consegna 3 settimane

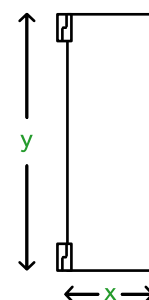

SCREEN BIANCA



Descrizione	TRASPARENTE	FROST PLUS
	Art.	Art.
Screen bianca da 66,5-68 cm + braccetto supporto	SC70B	SC70FB
Screen bianca da 76,5-78 cm + braccetto supporto	SC80B	SC80FB
Screen bianca da 86,5-88 cm + braccetto supporto	SC90B	SC90FB
Screen bianca da 96,5-98 cm + braccetto supporto	SC100B	SC100FB
Screen bianca da 106,5-108 cm + braccetto supporto	SC110B	SC110FB
Screen bianca da 116,5-118 cm + braccetto supporto	SC120B	SC120FB

*Incluso braccio girevole/regolabile 60-120 cm (art. 0186)

SCREEN BIANCA SU MISURA (vedi pag. 292)

Descrizione	TRASPARENTE	FROST PLUS
	Art.	Art.
Larghezza < 80 cm Altezza fino 195 cm	1305B	1305B+1313
Larghezza 80 a 120 cm Altezza fino 195 cm	1311B	1311B+1315

Tempo di consegna 3 settimane

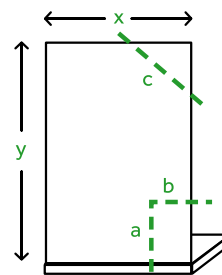

**QUADRATO/TAGLIO
PER VETRO SU MISURA**
Art.: 0862

SCREEN BIANCA cerniera mobile 180°



FISSI

	TRASPARENTE	FROST PLUS
Descrizione	Art.	Art.
Cr. mobile di 35 cm	0331BL	0332BL

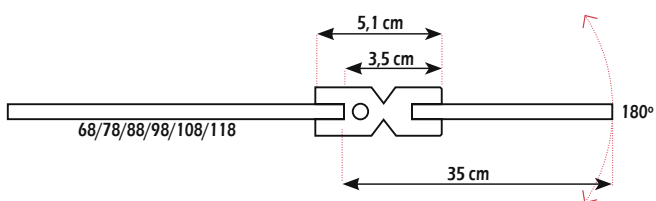

CERNIERE MOBILI BIANCO SU MISURA (vedi pag. 293)

	TRASPARENTE	FROST PLUS
Cm	Art.	Art.
Larghezza < 40 cm Altezza fino 195 cm	1355B	1357B
Larghezza 40 a 80 cm Altezza fino 195 cm	1356B	1358B

Tempo di consegna 3 settimane

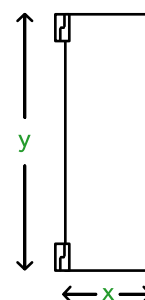

SCREEN ORO

Oro spazzolato



	TRASPARENTE	FROST PLUS
Descrizione	Art.	Art.
Screen oro da 66,5-68 cm + braccetto supporto oro	SC70OR	SC70FOR
Screen oro da 76,5-78 cm + braccetto supporto oro	SC80OR	SC80FOR
Screen oro da 86,5-88 cm + braccetto supporto oro	SC90OR	SC90FOR
Screen oro da 96,5-98 cm + braccetto supporto oro	SC100OR	SC100FOR
Screen oro da 106,5-108 cm + braccetto supporto oro	SC110OR	SC110FOR
Screen oro da 116,5-118 cm + braccetto supporto oro	SC120OR	SC120FOR

*Incluso braccio girevole/regolabile 60-120 cm (art.0187)

SCREEN ORO SU MISURA (vedi pag. 292)

	TRASPARENTE	FROST PLUS
Descrizione	Art.	Art.
Larghezza < 80 cm Altezza fino 195 cm	1305OR	1305OR+1313
Larghezza 80 a 120 cm Altezza fino 195 cm	1311OR	1311OR+1315

Tempo di consegna 3 settimane

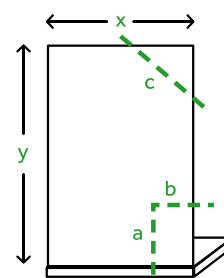

**QUADRATO/TAGLIO
PER VETRO SU MISURA**

Art.: 0862

SCREEN ORO cerniera mobile 180°

Oro spazzolato



FISSI

	TRASPARENTE	FROST PLUS
Descrizione	Art.	Art.
Cr. mobile di 35 cm	0331OR	0332OR

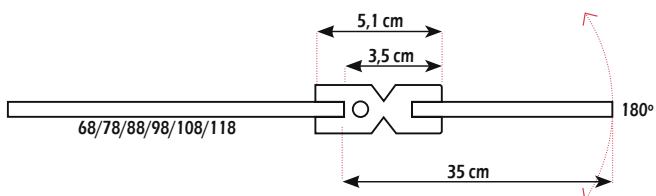

CERNIERE MOBILI ORO SU MISURA (vedi pag. 293)

	TRASPARENTE	FROST PLUS
Cm	Art.	Art.
Larghezza < 40 cm Altezza fino 195 cm	1355OR	1357OR
Larghezza 40 a 80 cm Altezza fino 195 cm	1356OR	1358OR

Tempo di consegna 3 settimane

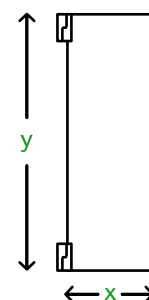

SCREEN RAME



Descrizione	TRASPARENTE	FROST PLUS
	Art.	Art.
Screen rame da 66,5-68 cm + braccetto supporto	SC70CB	SC70FCB
Screen rame da 76,5-78 cm + braccetto supporto	SC80CB	SC80FCB
Screen rame da 86,5-88 cm + braccetto supporto	SC90CB	SC90FCB
Screen rame da 96,5-98 cm + braccetto supporto	SC100CB	SC100FCB
Screen rame da 106,5-108 cm + braccetto supporto	SC110CB	SC110FCB
Screen rame da 116,5-118 cm + braccetto supporto	SC120CB	SC120FCB

***Incluso braccio girevole/regolabile 60-120 cm (art. 0189)**

SCREEN RAME SU MISURA (vedi pag. 292)

Descrizione	TRASPARENTE	FROST PLUS
	Art.	Art.
Larghezza < 80 cm Altezza fino 195 cm	1305CB	1305CB+1313
Larghezza 80 a 120 cm Altezza fino 195 cm	1311CB	1311CB+1315

Tempo di consegna 3 settimane

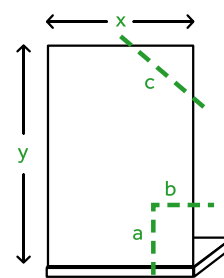

QUADRATO/TAGLIO PER VETRO SU MISURA

Art.: 0862

SCREEN RAME cerniera mobile 180°



FISSI

	TRASPARENTE	FROST PLUS
Descrizione	Art.	Art.
Cr. mobile di 35 cm	0331CB	0332CB

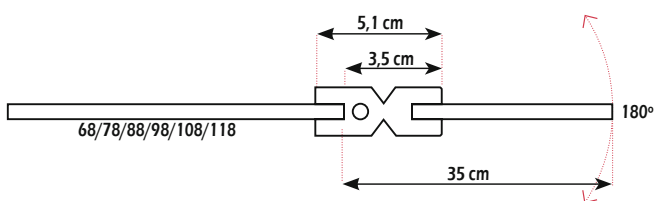

CERNIERE MOBILI RAME SU MISURA (vedi pag. 293)

	TRASPARENTE	FROST PLUS
Cm	Art.	Art.
Larghezza < 40 cm Altezza fino 195 cm	1355CB	1357CB
Larghezza 40 a 80 cm Altezza fino 195 cm	1356CB	1358CB

Tempo di consegna 3 settimane

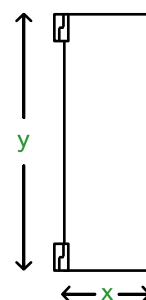

SCREEN NICHEL



	TRASPARENTE	FROST PLUS
Descrizione	Art.	Art.
Screen nichel da 66,5-68 cm + braccetto supporto	SC70NK	SC70FNK
Screen nichel da 76,5-78 cm + braccetto supporto	SC80NK	SC80FNK
Screen nichel da 86,5-88 cm + braccetto supporto	SC90NK	SC90FNK
Screen nichel da 96,5-98 cm + braccetto supporto	SC100NK	SC100FNK
Screen nichel da 106,5-108 cm + braccetto supporto	SC110NK	SC110FNK
Screen nichel da 116,5-118 cm + braccetto supporto	SC120NK	SC120FNK

***Incluso braccio girevole/regolabile 60-120 cm (art. 0191)**

SCREEN NICHEL SU MISURA (vedi pag. 292)

	TRASPARENTE	FROST PLUS
Descrizione	Art.	Art.
Larghezza < 80 cm Altezza fino 195 cm	1305NK	1305NK+1313
Larghezza 80 a 120 cm Altezza fino 195 cm	1311NK	1311NK+1315

Tempo di consegna 3 settimane

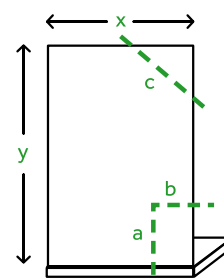

QUADRATO/TAGLIO PER VETRO SU MISURA
Art.: 0862

SCREEN NICHEL cerniera mobile 180°

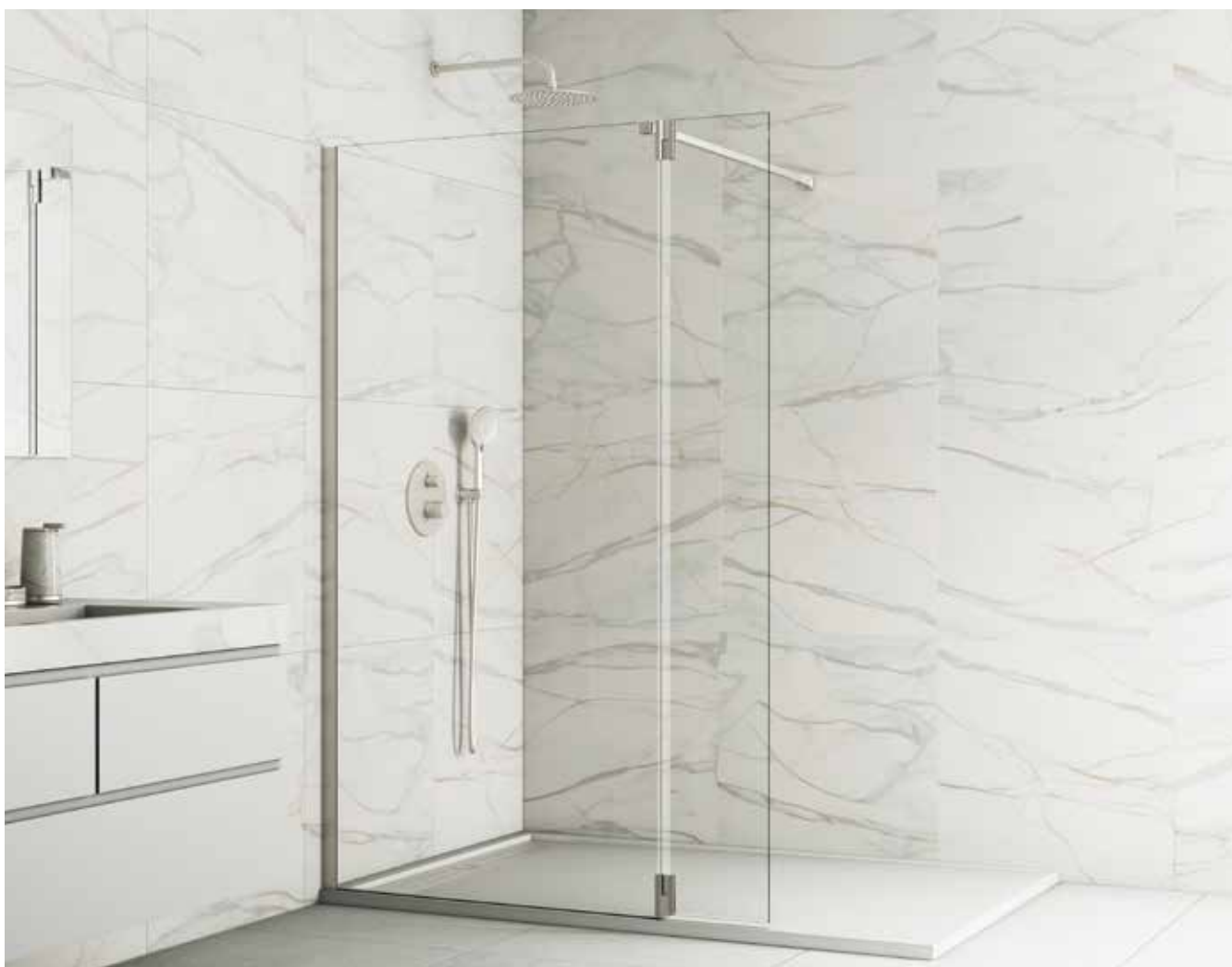

FISSI

	TRASPARENTE	FROST PLUS
Descrizione	Art.	Art.
Cr. mobile di 35 cm	0331NK	0332NK

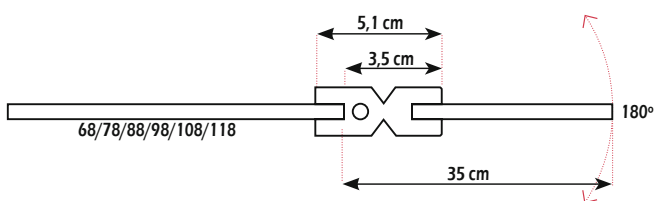

CERNIERE MOBILI NICHEL SU MISURA (vedi pag. 293)

	TRASPARENTE	FROST PLUS
Cm	Art.	Art.
Larghezza < 40 cm Altezza fino 195 cm	1355NK	1357NK
Larghezza 40 a 80 cm Altezza fino 195 cm	1356NK	1358NK

Tempo di consegna 3 settimane

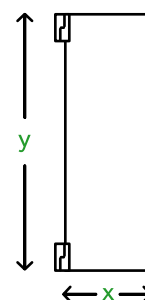

SCREEN TITANIO

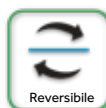

	TRASPARENTE	FROST PLUS
Descrizione	Art.	Art.
Screen titanio da 66,5-68 cm + braccetto supporto	SC70T	SC70FT
Screen titanio da 76,5-78 cm + braccetto supporto	SC80T	SC80FT
Screen titanio da 86,5-88 cm + braccetto supporto	SC90T	SC90FT
Screen titanio da 96,5-98 cm + braccetto supporto	SC100T	SC100FT
Screen titanio da 106,5-108 cm + braccetto supporto	SC110T	SC110FT
Screen titanio da 116,5-118 cm + braccetto supporto	SC120T	SC120FT

***Incluso braccio girevole/regolabile 60-120 cm (art. 0190)**

SCREEN TITANIO SU MISURA (vedi pag. 292)

	TRASPARENTE	FROST PLUS
Descrizione	Art.	Art.
Larghezza < 80 cm Altezza fino 195 cm	1305T	1305T+1313
Larghezza 80 a 120 cm Altezza fino 195 cm	1311T	1311T+1315

Tempo di consegna 3 settimane

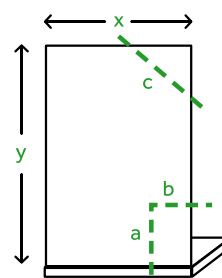

**QUADRATO/TAGLIO
PER VETRO SU MISURA**
Art.: 0862

SCREEN TITANIO cerniera mobile 180°



FISSI

	TRASPARENTE	FROST PLUS
Descrizione	Art.	Art.
Cr. mobile di 35 cm	0331T	0332T

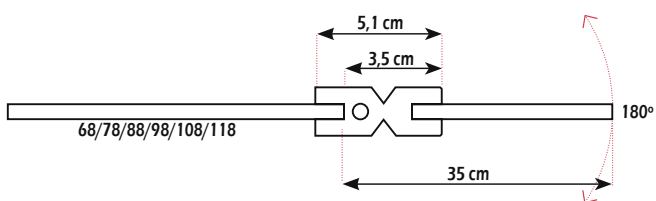

CERNIERE MOBILI TITANIO SU MISURA (vedi pag. 293)

	TRASPARENTE	FROST PLUS
Cm	Art.	Art.
Larghezza < 40 cm Altezza fino 195 cm	1355CB	1357CB
Larghezza 40 a 80 cm Altezza fino 195 cm	1356CB	1358CB

Tempo di consegna 3 settimane

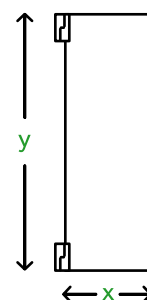

SCREEN BLACK SCACCHI



combinazione con art. 0983+0990



art. 0983+0986+0990

Cm	Estensibilità	Art.
Scacchi 70x195 + braccetto supporto	67-69,5	0980+0990
Scacchi 80x195 + braccetto supporto	77-79,5	0981+0990
Scacchi 90x195 + braccetto supporto	87-89,5	0982+0990
Scacchi 100x195 + braccetto supporto	97-99,5	0983+0990
Scacchi 110x195 + braccetto supporto	107-109,5	0984+0990
Scacchi 120x195 + braccetto supporto	117-119,5	0985+0990
35x195 cm pieghevole, installazione a destra		0986
35x195 cm pieghevole, installazione a sinistra		0987

Opzione profilo nero 2 m



Art.
0993

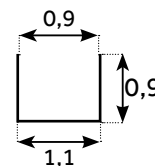

SCREEN BLACK SCACCHI XXL



combinazione con art. 2x0980+0990+0992

Utilizza il nuovo profilo di unione art. 0992 per unire qualsiasi articolo di fissi Screen Black ed ottenere misure superiori a 120 cm.

Descrizione	Art.
Profilo di unione nero per 2 cristalli fissi	0992

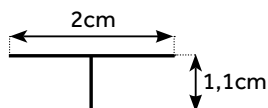

art. 0980+0983+0991+0990



BLACK SCACCHI ANGOLARE

Descrizione	Art.
Profilo angolare nero	0991

*Aumentare di 1,3 cm in uno dei lati

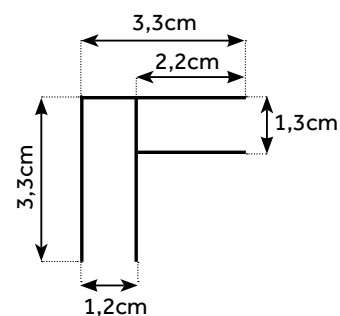

Braccetti Screen / Open / Glass

barra con 1 supporto + supporto laterale fisso



Supporto fissaggio a parete



Supporto fissaggio al fisso

Descrizione	CROMO	NERO	BIANCO	
Barra 140 con supporto (per frontale)	1716	9026	1716BL	
Barra 140 supporto + supporto laterale fisso	1716+1718	9026+9028	1716BL+1718BL	
Descrizione	ORO	RAME	NICHEL	TITANIO
Barra 140 con supporto (per frontale)	1716OR	1716CB	1716NK	1716T
Barra 140 supporto + supporto laterale fisso	1716OR+1718OR	1716CB+1718CB	1716NK+1718NK	1716T+1718T

barra rame con 2 supporti



Supporto fissaggio a laterale fisso art.1718

Descrizione	CROMO	NERO	BIANCO	
Barra 200 con due supporti (per frontale)	1717	9027	1717BL	
Barra 200 due supporti + supporto laterale fisso	1717+1718	9027+9028	1717BL+1718BL	
Descrizione	ORO	RAME	NICHEL	TITANIO
Barra 200 con due supporti (per frontale)	1717OR	1717CB	1717NK	1717T
Barra 200 due supporti + supporto laterale fisso	1717OR+1718OR	1717CB+1718CB	1717NK+1718NK	1717T+1718T

Braccetto 60-120 cm diritto/45°



CROMO	NERO	BIANCO	
0184	0990	0186	
ORO	RAME	NICHEL	TITANIO
0187	0189	0191	0190

Profilo angolare

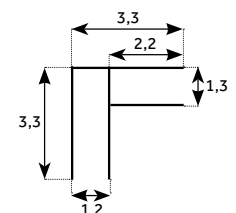

CROMO	NERO	BIANCO	
0182	0991	0182BL	
ORO	RAME	NICHEL	TITANIO
0182OR	0182CB	0182NK	0182T

*Aumentare di 1,3 cm su un lato



Descrizione	CROMO	NERO
Angolo minimale 20x40 cm	1719	1719N



Descrizione	Art.
Appendiabiti GME	0012



Descrizione	Art.
Barra soffitto Screen	0188

Altezza massima 260 cm



Descrizione	Art.
Barra apertura angolare GLASS/OPEN	1716x2+1730

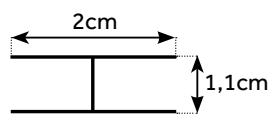

Descrizione	Art.
Profilo di unione per 2 fissi	0180
Profilo di unione nero per 2 fissi	0992

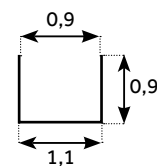

Descrizione	Art.
Opzione profilo in alluminio 2 m	0994
Opzione profilo nero 2 m	0993

open

“Programma modulare di
fissi e porte che si adattano
a qualsiasi spazio”

● CROMO

● NERO





A BATTENTE

OPEN COMBI A porta con chiusura magnetica a parete



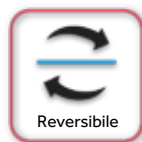

COMBI A

Estensibilità (cm)	Apertura	CROMO	NERO
40,1-41,6	33	OP40AR	-
41,1-42,6	33	OP40A	-
45,1-46,6	38	OP45AR	-
46,1-47,6	38	OP45A	-
50,1-51,6	43	OP50AR	OP50ANR
51,1-52,6	43	OP50A	OP50AN
55,1-56,6	48	OP55AR	OP55ANR
56,1-57,6	48	OP55A	OP55AN
60,1-61,6	53	OP60AR	OP60ANR
61,1-62,6	53	OP60A	OP60AN
65,1-66,6	58	OP65AR	OP65ANR
66,1-67,6	58	OP65A	OP65AN
70,1-71,6	63	OP70AR	OP70ANR
71,1-72,6	63	OP70A	OP70AN
75,1-76,6	68	OP75AR	OP75ANR
76,1-77,6	68	OP75A	OP75AN
80,1-81,6	73	OP80AR	OP80ANR
81,1-82,6	73	OP80A	OP80AN
85,1-86,6	78	OP85AR	OP85ANR
86,1-87,6	78	OP85A	OP85AN

*Permette unione con laterali fissi STD nel lato della porta usando art. 1222 (estensione minima +1,8 cm), vedi pag. 295 I riferimenti che terminano con R utilizzano il profilo art. 1215/9014, mentre gli altri utilizzano art. 1211/9012.

Descrizione	CROMO	NERO
Profilo espansione porte (+1,5 a +3 cm)	1222	9015
Magnete espansione +1,2 cm	1221	
Opzione apertura IN-OUT 180°	1213	

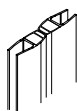

Opzione 180°

OPEN COMBI A + lat. fisso

Apertura esterna
90° p/fisso





Opzione in-out
0180° p/fisso



L'estensibilità del frontale con apertura in-out aumenterà di 1,4 cm l'estensibilità del laterale fisso si riduce di 1 cm.



Opzioni accessorie

Descrizione	 CROMO	 NERO
Profilo espansione +1,5 a +3 cm per porta a battente	1222	9015
Profilo espansione +2 cm per laterale fisso	0218	9016
Profilo espansione +4 cm per laterale fisso	0029	-

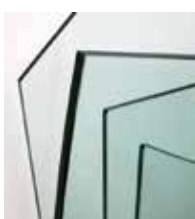

Lati fissi su misura **6 mm**

Descrizione	Art.
Laterale fisso su misura fino 40 cm	1345
Laterale fisso su misura da 40 fino 80 cm	1316
Laterale fisso su misura da 80 fino 120 cm	1317

*Tempo di consegna 3 settimane. Altre informazioni vedi pag. 291

PASSO 1 - Selezione misura frontale (porta)

Estensibilità (cm)	Apertura	CROMO	NERO
39,6-41,1	43	OP40AR	-
40,6-42,1	43	OP40A	-
44,6-46,1	43	OP45AR	-
45,6-47,1	48	OP45A	-
49,6-51,1	43	OP50AR	OP50ANR
50,6-52,1	58	OP50A	OP50AN
54,6-56,1	63	OP55AR	OP55ANR
55,6-57,1	43	OP55A	OP55AN
59,6-61,1	58	OP60AR	OP60ANR
60,6-62,1	73	OP60A	OP60AN
64,6-66,1	63	OP65AR	OP65ANR
65,6-67,1	43	OP65A	OP65AN
69,6-71,1	58	OP70AR	OP70ANR
70,6-72,1	73	OP70A	OP70AN
74,6-76,1	63	OP75AR	OP75ANR
75,6-77,1	58	OP75A	OP75AN
79,6-81,1	73	OP80AR	OP80ANR
80,6-82,1	63	OP80A	OP80AN
84,6-86,1	78	OP85AR	OP85ANR
85,6-87,1	73	OP85A	OP85AN

*Permette unione con laterali fissi STD nel lato della porta usando art. 1222/9015 (estensione minima +1,8 cm), vedi pag. 198
I riferimenti che terminano con R utilizzano il profilo art. 1215/9014, mentre gli altri utilizzano art. 1211/9012.

PASSO 2 - Selezione misura lat. fisso

Estensibilità (cm)	CROMO	NERO
66-69	1720CR	1720N
76-79	1721CR	1721N
86-89	1722CR	1722N

PASSO 3 - Selezionare il supporto

Descrizione	CROMO	NERO
Braccio regolabile/girevole 60 cm	1715	1715N
Barra parallela + supporto fino a 140 cm	1716+1718	9026+9028



OPEN COMBI B porta con profilo a chiusura magnetica



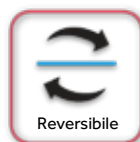

COMBI B

Estensibilità (cm)	Apertura	CROMO	NERO
42,6-46,6	33	OP45BR	-
43,6-47,6	33	OP45B	-
47,6-51,6	38	OP50BR	-
48,6-52,6	38	OP50B	-
52,6-56,6	43	OP55BR	OP55BNR
53,6-57,6	43	OP55B	OP55BN
57,6-61,6	48	OP60BR	OP60BNR
58,6-62,6	48	OP60B	OP60BN
62,6-66,6	53	OP65BR	OP65BNR
63,6-67,6	53	OP65B	OP65BN
67,6-71,6	58	OP70BR	OP70BNR
68,6-72,6	58	OP70B	OP70BN
72,6-76,6	63	OP75BR	OP75BNR
73,6-77,6	63	OP75B	OP75BN
77,6-81,6	68	OP80BR	OP80BNR
78,6-82,6	68	OP80B	OP80BN
82,6-86,6	73	OP85BR	OP85BNR
83,6-87,6	73	OP85B	OP85BN
87,6-91,6	78	OP90BR	OP90BNR
88,6-92,6	78	OP90B	OP90BN

Permette unione con laterali fissi STD nel lato profilo a chiusura magnetica (estensione minima +0,7 cm, espansione +1,5 cm), vedi pag. 198
 Permette unione con laterali fissi STD nel lato porta usando art. 1222 (estensione minima +1,8 cm, espansione +2,5 cm), vedi pag. 198

Descrizione	CROMO	NERO
Profilo espansione lato profilo a chiusura magnetica +3 cm	0218	9016
Profilo espansione lato profilo a chiusura magnetica +6 cm	0029	-
Magnete espansione +1,2 cm, vedi pag. 295	1221	
Profilo espansione laterale porta +2,5 cm, vedi pag. 295	1222	9015
Opzione apertura IN-OUT 180°	1213	

OPEN COMBI C Fisso + battente chiusura magnetica a parete

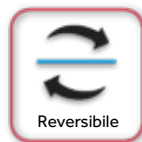

Opzioni accessorie

Descrizione.	● CROMO	● NERO
Profilo espansione lato profilo a chiusura magnetica +3 cm	0218	9016
Profilo espansione lato profilo a chiusura magnetica +6 cm	0029	-
Magnete espansione +1,2 cm, vedi pag. 295	1221	
Opzione apertura IN-OUT 180°	1213	



Pannelli fissi su misura
(vedi pag. 289)

PASSO 1 - Selezionare il supporto

Descrizione	CROMO	NERO
Braccio regolabile/girevole 60 cm	1715	1715N
Barra parallela + supporto fino a 140 cm	1716	9026

PASSO 2 - Selezione combi C (fisso+porta)

Cm	Estensibilità	Fisso	Porta	Apertura	CROMO	NERO
70	67,5-70	20	50	43	OP2050C	OP2050CN
75	72,5-75	25	50	43	OP2550C	OP2550CN
75	72,5-75	20	55	48	OP2055C	OP2055CN
80	77,5-80	30	50	43	OP3050C	OP3050CN
80	77,5-80	25	55	48	OP2555C	OP2555CN
80	77,5-80	20	60	53	OP2060C	OP2060CN
85	82,5-85	30	55	48	OP3055C	OP3055CN
85	82,5-85	25	60	53	OP2560C	OP2560CN
85	82,5-85	20	65	58	OP2065C	OP2065CN
90	87,5-90	40	50	43	OP4050C	OP4050CN
90	87,5-90	30	60	53	OP3060C	OP3060CN
90	87,5-90	25	65	58	OP2565C	OP2565CN
90	87,5-90	20	70	63	OP2070C	OP2070CN
95	92,5-95	40	55	48	OP4055C	OP4055CN
95	92,5-95	30	65	58	OP3065C	OP3065CN
95	92,5-95	25	70	63	OP2570C	OP2570CN
100	97,5-100	50	50	43	OP5050C	OP5050CN
100	97,5-100	40	60	53	OP4060C	OP4060CN
100	97,5-100	30	70	63	OP3070C	OP3070CN
100	97,5-100	20	80	73	OP2080C	OP2080CN
105	102,5-105	50	55	48	OP5055C	OP5055CN
105	102,5-105	40	65	58	OP4065C	OP4065CN
105	102,5-105	30	75	68	OP3075C	OP3075CN
110	107,5-110	60	50	43	OP6050C	OP6050CN
110	107,5-110	50	60	53	OP5060C	OP5060CN
110	107,5-110	40	70	63	OP4070C	OP4070CN
110	107,5-110	30	80	73	OP3080C	OP3080CN
115	112,5-115	60	55	48	OP6055C	OP6055CN
115	112,5-115	50	65	58	OP5065C	OP5065CN
115	112,5-115	40	75	68	OP4075C	OP4075CN
115	112,5-115	30	85	78	OP3085C	OP3085CN
120	117,5-120	60	60	53	OP6060C	OP6060CN
120	117,5-120	50	70	63	OP5070C	OP5070CN
120	117,5-120	40	80	73	OP4080C	OP4080CN
125	122,5-125	60	65	58	OP6065C	OP6065CN
125	122,5-125	50	75	68	OP5075C	OP5075CN
125	122,5-125	40	85	78	OP4085C	OP4085CN
130	127,5-130	60	70	63	OP6070C	OP6070CN
130	127,5-130	50	80	73	OP5080C	OP5080CN
135	132,5-135	60	75	68	OP6075C	OP6075CN
135	132,5-135	50	85	78	OP5085C	OP5085CN
140	137,5-140	60	80	73	OP6080C	OP6080CN
145	142,5-145	60	85	78	OP6085C	OP6085CN

*Permette combinazione con laterale fisso STD nel lato fisso, estensione minima +0,7 (non regolabile), vedi pag 198

*Permette combinazione con laterale fisso Glass nel lato della porta, l'estensione del frontale si riduce di 0,5 cm

OPEN COMBI C + lat. fisso

Apertura esterna
90° p/fisso



Opzione in-out
0180° p/fisso



L'estensibilità del frontale con apertura in-out aumenterà di 1,4 cm l'estensibilità del laterale fisso si riduce di 1 cm.



Opzioni accessorie

Descrizione	CROMO	NERO
Profilo espansione +2 cm	0218	9016
Profilo espansione +4 cm	0029	-



Lati fissi su misura **6 mm** (maggiori informazioni a pagina 291)

Descrizione	Art.
Laterale fisso su misura OPEN fino 40 cm	1345
Laterale fisso su misura OPEN da 40 fino 80 cm	1316
Laterale fisso su misura OPEN da 80 fino 120 cm	1317

*Tempo di consegna 3 settimane

PASSO 1 - Selezione misura frontale (fisso+porta)

Cm	Estensibilità (cm)	Apertura	CROMO	NERO
70 (20+50)	67-69,5	43	OP2050C	OP2050CN
75 (25+50)	72-74,5	43	OP2550C	OP2550CN
80 (30+50)	77-79,5	43	OP3050C	OP3050CN
85 (30+55)	82-84,5	48	OP3055C	OP3055CN
90 (40+50)	87-89,5	43	OP4050C	OP4050CN
95 (30+65)	92-94,5	58	OP3065C	OP3065CN
100 (30+70)	97-99,5	63	OP3070C	OP3070CN
100 (50+50)	97-99,5	43	OP5050C	OP5050CN
105 (40+65)	102-104,5	58	OP4065C	OP4065CN
110 (30+80)	107-109,5	73	OP3080C	OP3080CN
110 (40+70)	107-109,5	63	OP4070C	OP4070CN
110 (60+50)	107-109,5	43	OP6050C	OP6050CN
115 (50+65)	112-114,5	58	OP5065C	OP5065CN
120 (40+80)	117-119,5	73	OP4080C	OP4080CN
120 (50+70)	117-119,5	63	OP5070C	OP5070CN
125 (60+65)	122-124,5	58	OP6065C	OP6065CN
130 (50+80)	127-129,5	73	OP5080C	OP5080CN
130 (60+70)	127-129,5	63	OP6070C	OP6070CN
135 (50+85)	132-134,5	78	OP5085C	OP5085CN
140 (60+80)	137-139,5	73	OP6080C	OP6080CN
145 (60+85)	142-144,5	78	OP6085C	OP6085CN

*Permette combinazione con laterale fissoSTD nel lato della porta utilizzando art. 1222 (estensione minima +1,8 cm), vedi pag. 198.

*È possibile selezionare qualsiasi altra combinazione dalla tabella a pagina 169, estensione -0,5 cm.

PASSO 2 - Selezione misura lat. fisso

Estensibilità (cm)	CROMO	NERO
66-69	1720CR	1720N
76-79	1721CR	1721N
86-89	1722CR	1722N

PASSO 3 - Selezionare il supporto

Descrizione	CROMO	NERO
Braccio regolabile/girevole 60 cm	1715+1715	1715N+1715N
Barra parallela + supporto fino a 140 cm	1716+1718	9026+9028



OPEN COMBI D fisso+battente e prof. a chiusura magnetica

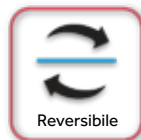

Opzioni accessorie

Descrizione	● CROMO	● NERO
Profilo espansione lato profilo a chiusura magnetica +3 cm	0218	9016
Profilo espansione lato profilo a chiusura magnetica +6 cm	0029	-
Magnete espansione +1,2 cm, vedi pag. 295	1221	
Opzione apertura IN-OUT 180°	1213	





Pannelli fissi su misura (vedi pag. 289)

PASSO 1 - Selezionare il supporto

Descrizione	 CROMO	 NERO
Braccio regolabile/girevole 60 cm	1715	1715N
Barra parallela + supporto fino a 140 cm	1716	9026

PASSO 2 - Selezione combi D (fisso+porta)

Cm	Estensibilità (cm)	Fisso	Porta	Apertura	 CROMO	 NERO
70	70-75	20	50	43	OP2050D	OP2050DN
75	75-80	25	50	43	OP2550D	OP2550DN
75	75-80	20	55	48	OP2055D	OP2055DN
80	80-85	30	50	43	OP3050D	OP3050DN
80	80-85	25	55	48	OP2555D	OP2555DN
80	80-85	20	60	53	OP2060D	OP2060DN
85	85-90	30	55	48	OP3055D	OP3055DN
85	85-90	25	60	53	OP2560D	OP2560DN
85	85-90	20	65	58	OP2065D	OP2065DN
90	90-95	40	50	43	OP4050D	OP4050DN
90	90-95	30	60	53	OP3060D	OP3060DN
90	90-95	25	65	58	OP2565D	OP2565DN
90	90-95	20	70	63	OP2070D	OP2070DN
95	95-100	40	55	48	OP4055D	OP4055DN
95	95-100	30	65	58	OP3065D	OP3065DN
95	95-100	25	70	63	OP2570D	OP2570DN
100	100-105	50	50	43	OP5050D	OP5050DN
100	100-105	40	60	53	OP4060D	OP4060DN
100	100-105	30	70	63	OP3070D	OP3070DN
100	100-105	20	80	73	OP2080D	OP2080DN
105	105-110	50	55	48	OP5055D	OP5055DN
105	105-110	40	65	58	OP4065D	OP4065DN
105	105-110	30	75	68	OP3075D	OP3075DN
110	110-115	60	50	43	OP6050D	OP6050DN
110	110-115	50	60	53	OP5060D	OP5060DN
110	110-115	40	70	63	OP4070D	OP4070DN
110	110-115	30	80	73	OP3080D	OP3080DN
115	115-120	60	55	48	OP6055D	OP6055DN
115	115-120	50	65	58	OP5065D	OP5065DN
115	115-120	40	75	68	OP4075D	OP4075DN
115	115-120	30	85	78	OP3085D	OP3085DN
120	120-125	60	60	53	OP6060D	OP6060DN
120	120-125	50	70	63	OP5070D	OP5070DN
120	120-125	40	80	73	OP4080D	OP4080DN
125	125-130	60	65	58	OP6065D	OP6065DN
125	125-130	50	75	68	OP5075D	OP5075DN
125	125-130	40	85	78	OP4085D	OP4085DN
130	130-135	60	70	63	OP6070D	OP6070DN
130	130-135	50	80	73	OP5080D	OP5080DN
135	135-140	60	75	68	OP6075D	OP6075DN
135	135-140	50	85	78	OP5085D	OP5085DN
140	140-145	60	80	73	OP6080D	OP6080DN
145	145-150	60	85	78	OP6085D	OP6085DN



A BATTENTE

*Permette combinazione con laterale fisso STD nel lato fisso, estensione minima +0,7 (non regolabile), vedi pag 198

OPEN COMBI E fisso + porta a battente con chiusura a fisso



Opzioni accessorie

Descrizione.	 CROMO	 NERO
Profilo espansione lato profilo a chiusura magnetica +3 cm	0218	9016
Profilo porta (riduce fino 1 cm l'estensione), vedi pag. 295	1215	9014
Profilo espansione laterale porta +2,5 cm, vedi pag. 295	1222	9015
Magnete espansione +1,2 cm, vedi pag. 295	1221	
Opzione apertura IN-OUT 180°	1213	



Pannelli fissi
su misura
(vedi pag. 289)



PASSO 1 - Selezionare il supporto

Descrizione	● CROMO	● NERO
Braccio regolabile/girevole 60 cm	1715	1715N
Barra parallela + supporto fino a 140 cm	1716	9026



PASSO 2 - Selezione combi E (fisso + porta)

Cm	Estensibilità	Fisso	Porta	Apertura	● CROMO	● NERO
70	68,6-72,6	20	50	43	OP2050E	OP2050EN
75	73,6-77,6	25	50	43	OP2550E	OP2550EN
80	78,6-82,6	30	50	43	OP3050E	OP3050EN
85	83,6-87,6	20	65	58	OP2065E	OP2065EN
85	83,6-87,6	30	55	48	OP3055E	OP3055EN
90	88,6-92,6	20	70	43	OP2070E	OP2070EN
90	88,6-92,6	25	65	58	OP2565E	OP2565EN
90	88,6-92,6	40	50	63	OP4050E	OP4050EN
95	93,6-97,6	25	70	63	OP2570E	OP2570EN
95	93,6-97,6	30	65	58	OP3065E	OP3065EN
100	98,6-102,6	20	80	63	OP2080E	OP2080EN
100	98,6-102,6	30	70	73	OP3070E	OP3070EN
100	98,6-102,6	50	50	43	OP5050E	OP5050EN
105	103,6-107,6	25	80	73	OP2580E	OP2580EN
105	103,6-107,6	40	65	58	OP4065E	OP4065EN
110	108,6-112,6	30	80	73	OP3080E	OP3080EN
110	108,6-112,6	40	70	63	OP4070E	OP4070EN
110	108,6-112,6	60	50	43	OP6050E	OP6050EN
115	113,6-117,6	50	65	58	OP5065E	OP5065EN
120	118,6-122,6	40	80	73	OP4080E	OP4080EN
120	118,6-122,6	50	70	63	OP5070E	OP5070EN
125	123,6-127,6	60	65	58	OP6065E	OP6065EN
130	128,6-132,6	50	80	73	OP5080E	OP5080EN
130	128,6-132,6	60	70	63	OP6070E	OP6070EN
135	133,6-137,6	50	85	78	OP5085E	OP5085EN
140	138,6-142,6	60	80	73	OP6080E	OP6080EN
145	143,6-147,6	60	85	78	OP6085E	OP6085EN

*Permette combinazione con laterale fisso STD nel lato fisso, estensione minima +0,7 / espansione 1,5 cm (vedi pag. 198)

*Permette unione laterale fisso STD nel lato porta usando art.1222/9015, estensione minima +1,8 cm / espansione 2,5 cm (vedi pag. 198)

OPEN COMBI F fisso + porta a battente + fisso



Opzioni accessorie

Descrizione	● CROMO	● NERO
Profilo espansione lato profilo a chiusura magnetica +3 cm	0218	9016
Profilo espansione lato profilo a chiusura magnetica +6 cm	0029	-
Magnete espansione +1,2 cm, vedi pag. 295	1221	
Opzione apertura IN-OUT 180°	1213	







Pannelli fissi
su misura
(vedi pag. 289)

PASSO 1 - Selezionare il supporto

Descrizione	 CROMO	 NERO
Braccio regolabile/girevole 60 cm	1715+1715	1715N+1715N
Barra parallela con 2 supporti fino 200 cm	1717	9027

PASSO 2 - Selezione combi F (fisso+porta+fisso)

Cm F+P+F	Est.	 CROMO	 NERO	Cm F+P+F	Est.	 CROMO	 NERO
90 (20+50+20)	85-90	OP205020F	OP205020FN	145 (25+70+50)	140-145	OP257050F	OP257050FN
95 (20+50+25)	90-95	OP205025F	OP205025FN	145 (25+80+40)	140-145	OP258040F	OP258040FN
100 (25+50+25)	95-100	OP255025F	OP255025FN	145 (20+65+60)	140-145	OP206560F	OP206560FN
100 (20+50+30)	95-100	OP205030F	OP205030FN	150 (40+50+60)	145-150	OP405060F	OP405060FN
105 (25+50+30)	100-105	OP255030F	OP255030FN	150 (25+65+60)	145-150	OP256560F	OP256560FN
105 (20+65+20)	100-105	OP206520F	OP206520FN	150 (20+70+60)	145-150	OP207060F	OP207060FN
110 (20+65+25)	105-110	OP206525F	OP206525FN	150 (30+70+50)	145-150	OP307050F	OP307050FN
110 (20+70+20)	105-110	OP207020F	OP207020FN	150 (40+70+40)	145-150	OP407040F	OP407040FN
110 (30+50+30)	105-110	OP305030F	OP305030FN	150 (30+80+40)	145-150	OP308040F	OP308040FN
115 (20+65+30)	110-115	OP206530F	OP206530FN	150 (20+80+50)	145-150	OP208050F	OP208050FN
115 (20+70+25)	110-115	OP207025F	OP207025FN	155 (30+65+60)	150-155	OP306560F	OP306560FN
120 (30+50+40)	115-120	OP305040F	OP305040FN	155 (25+70+60)	150-155	OP257060F	OP257060FN
120 (25+65+30)	115-120	OP256530F	OP256530FN	155 (40+65+50)	150-155	OP406550F	OP406550FN
120 (20+70+30)	115-120	OP207030F	OP207030FN	155 (25+80+50)	150-155	OP258050F	OP258050FN
120 (20+80+20)	115-120	OP208020F	OP208020FN	160 (50+50+60)	155-160	OP505060F	OP505060FN
125 (20+65+40)	120-125	OP206540F	OP206540FN	160 (30+70+60)	155-160	OP307060F	OP307060FN
125 (30+65+30)	120-125	OP306530F	OP306530FN	160 (40+70+50)	155-160	OP407050F	OP407050FN
125 (25+70+30)	120-125	OP257030F	OP257030FN	160 (30+80+50)	155-160	OP308050F	OP308050FN
125 (25+80+20)	120-125	OP258020F	OP258020FN	160 (20+80+60)	155-160	OP208060F	OP208060FN
130 (25+65+40)	125-130	OP256540F	OP256540FN	160 (40+80+40)	155-160	OP408040F	OP408040FN
130 (20+70+40)	125-130	OP207040F	OP207040FN	165 (40+65+60)	160-165	OP406560F	OP406560FN
130 (30+70+30)	125-130	OP307030F	OP307030FN	165 (50+65+50)	160-165	OP506550F	OP506550FN
130 (20+80+30)	125-130	OP208030F	OP208030FN	165 (25+80+60)	160-165	OP258060F	OP258060FN
130 (20+50+60)	125-130	OP205060F	OP205060FN	170 (60+50+60)	165-170	OP605060F	OP605060FN
135 (20+65+50)	130-135	OP206550F	OP206550FN	170 (40+70+60)	165-170	OP407060F	OP407060FN
135 (30+65+40)	130-135	OP306540F	OP306540FN	170 (50+70+50)	165-170	OP507050F	OP507050FN
135 (25+70+40)	130-135	OP257040F	OP257040FN	170 (30+80+60)	165-170	OP308060F	OP308060FN
135 (25+80+30)	130-135	OP258030F	OP258030FN	170 (40+80+50)	165-170	OP408050F	OP408050FN
135 (25+50+60)	130-135	OP255060F	OP255060FN	175 (50+65+60)	170-175	OP506560F	OP506560FN
140 (25+65+50)	135-140	OP256550F	OP256550FN	180 (50+70+60)	175-180	OP507060F	OP507060FN
140 (20+70+50)	135-140	OP207050F	OP207050FN	180 (40+80+60)	175-180	OP408060F	OP408060FN
140 (30+70+40)	135-140	OP307040F	OP307040FN	180 (50+80+50)	175-180	OP508050F	OP508050FN
140 (20+80+40)	135-140	OP208040F	OP208040FN	185 (60+65+60)	180-185	OP606560F	OP606560FN
140 (30+80+30)	135-140	OP308030F	OP308030FN	190 (60+70+60)	185-190	OP607060F	OP607060FN
140 (30+50+60)	135-140	OP305060F	OP305060FN	190 (50+80+60)	185-190	OP508060F	OP508060FN
145 (30+65+50)	140-145	OP306550F	OP306550FN	200 (60+80+60)	195-200	OP608060F	OP608060FN
145 (40+65+40)	140-145	OP406540F	OP406540FN				

*Permette unione con laterale fisso STD in entrambi i lati (estens.minima +0,7 cm / regol. 2,5 cm), vedi pag. 198.

*Permette uso profilo di compensazione in entrambi i lati

OPEN COMBI G fisso + 2 porte a battente + fisso



PASSO 1 - Selezionare il supporto

Descrizione	● CROMO	● NERO
Braccio regolabile/girevole 60 cm	1715+1715	1715N+1715N
Barra parallela con 2 supporti fino 200 cm	1717	9027



1715



1717

PASSO 2 - Selezione combi G (fisso+porta+porta+fisso)

Cm F+P+P+F	Estensibilità (cm)	CROMO	NERO
135 (20+50+50+20)	131,2/136,2	OP20505020G	OP20505020GN
145 (25+50+50+25)	141,2/146,2	OP25505025G	OP25505025GN
145 (20+55+55+20)	141,2/146,2	OP20555520G	OP20555520GN
155 (30+50+50+30)	151,2/156,2	OP30505030G	OP30505030GN
155 (25+55+55+25)	151,2/156,2	OP25555525G	OP25555525GN
155 (20+60+60+20)	151,2/156,2	OP20606020G	OP20606020GN
165 (30+55+55+30)	161,2/166,2	OP30555530G	OP30555530GN
165 (25+60+60+25)	161,2/166,2	OP25606025G	OP25606025GN
165 (20+65+65+20)	161,2/166,2	OP20656520G	OP20656520GN
175 (40+50+50+40)	171,2/176,2	OP40505040G	OP40505040GN
175 (30+60+60+30)	171,2/176,2	OP30606030G	OP30606030GN
175 (25+65+65+25)	171,2/176,2	OP25656525G	OP25656525GN
175 (20+70+70+20)	171,2/176,2	OP20707020G	OP20707020GN
185 (40+55+55+40)	181,2/186,2	OP40555540G	OP40555540GN
185 (30+65+65+30)	181,2/186,2	OP30656530G	OP30656530GN
185 (25+70+70+25)	181,2/186,2	OP25707025G	OP25707025GN
185 (20+75+75+20)	181,2/186,2	OP20757520G	OP20757520GN
195 (50+50+50+50)	191,2/196,2	OP50505050G	OP50505050GN
195 (40+60+60+40)	191,2/196,2	OP40606040G	OP40606040GN
195 (30+70+70+30)	191,2/196,2	OP30707030G	OP30707030GN
195 (25+75+75+25)	191,2/196,2	OP25757525G	OP25757525GN
195 (20+80+80+20)	191,2/196,2	OP20808020G	OP20808020GN
205 (50+55+55+50)	201,2/206,2	OP50555550G	OP50555550GN
205 (40+65+65+40)	201,2/206,2	OP40656540G	OP40656540GN
205 (30+75+75+30)	201,2/206,2	OP30757530G	OP30757530GN
205 (25+80+80+25)	201,2/206,2	OP25808025G	OP25808025GN
205 (20+85+85+20)	201,2/206,2	OP20858520G	OP20858520GN
215 (60+50+50+60)	211,2/216,2	OP60505060G	OP60505060GN
215 (50+60+60+50)	211,2/216,2	OP50606050G	OP50606050GN
215 (40+70+70+40)	211,2/216,2	OP40707040G	OP40707040GN
215 (30+80+80+30)	211,2/216,2	OP30808030G	OP30808030GN
215 (25+85+85+25)	211,2/216,2	OP25858525G	OP25858525GN
225 (60+55+55+60)	221,2/226,2	OP60555560G	OP60555560GN
225 (50+65+65+50)	221,2/226,2	OP50656550G	OP50656550GN
225 (40+75+75+40)	221,2/226,2	OP40757540G	OP40757540GN
225 (30+85+85+30)	221,2/226,2	OP30858530G	OP30858530GN
235 (60+60+60+60)	231,2/236,2	OP60606060G	OP60606060GN
235 (50+70+70+50)	231,2/236,2	OP50707050G	OP50707050GN
235 (40+80+80+40)	231,2/236,2	OP40808040G	OP40808040GN
245 (60+65+65+60)	241,2/246,2	OP60656560G	OP60656560GN
245 (50+75+75+50)	241,2/246,2	OP50757550G	OP50757550GN
245 (40+85+85+40)	241,2/246,2	OP40858540G	OP40858540GN
255 (60+70+70+60)	251,2/256,2	OP60707060G	OP60707060GN
255 (50+80+80+50)	251,2/256,2	OP50808050G	OP50808050GN
265 (60+75+75+60)	261,2/266,2	OP60757560G	OP60757560GN
265 (50+85+85+50)	261,2/266,2	OP50858550G	OP50858550GN
275 (60+80+80+60)	271,2/276,2	OP60808060G	OP60808060GN
285 (60+85+85+60)	281,2/286,2	OP60858560G	OP60858560GN

A BATTENTE

*Permette unione con laterale fisso STD in entrambi i lati (estens.minima +0,7 cm / regol. 2,5 cm), vedi pag. 198.

*Permette uso profilo di compensazione in entrambi i lati



*Per altre combinazioni, vedere i dettagli a pagina 197

OPEN COMBI H angolare 2 porte a battente + 2 fissi

OP3070C+OP2050C+1716+1716+1730



Opzioni accessorie

Descrizione	 CROMO	 NERO
Profilo espansione lato profilo a chiusura magnetica +3 cm	0218	9016
Profilo espansione lato profilo a chiusura magnetica +6 cm	0029	-

PASSO 1 - Selezionare il supporto

Descrizione	CROMO	NERO
Braccio regolabile/girevole 60 cm	1715+1715	1715N+1715N
Barra parallela + supporto fino a 140 cm	1716+1716+1730	-



PASSO 2 - Selezione dei 2 lati del box doccia (fisso+porta)

Cm	Estensibilità	Fisso	Porta	CROMO	NERO
70	67-69,5	20	50	OP2050C	OP2050CN
75	72-74,5	25	50	OP2550C	OP2550CN
75	72-74,5	20	55	OP2055C	OP2055CN
80	77-79,5	30	50	OP3050C	OP3050CN
80	77-79,5	25	55	OP2555C	OP2555CN
80	77-79,5	20	60	OP2060C	OP2060CN
85	82-84,5	30	55	OP3055C	OP3055CN
85	82-84,5	25	60	OP2560C	OP2560CN
85	82-84,5	20	65	OP2065C	OP2065CN
90	87-89,5	40	50	OP4050C	OP4050CN
90	87-89,5	30	60	OP3060C	OP3060CN
90	87-89,5	25	65	OP2565C	OP2565CN
90	87-89,5	20	70	OP2070C	OP2070CN
95	92-94,5	40	55	OP4055C	OP4055CN
95	92-94,5	30	65	OP3065C	OP3065CN
95	92-94,5	25	70	OP2570C	OP2570CN
100	97-99,5	50	50	OP5050C	OP5050CN
100	97-99,5	40	60	OP4060C	OP4060CN
100	97-99,5	30	70	OP3070C	OP3070CN
100	97-99,5	25	75	OP2575C	OP2575CN
105	102-104,5	50	55	OP5055C	OP5055CN
105	102-104,5	40	65	OP4065C	OP4065CN
105	102-104,5	30	75	OP3075C	OP3075CN
105	102-104,5	25	80	OP2580C	OP2580CN
110	107-109,5	50	60	OP5060C	OP5060CN
110	107-109,5	40	70	OP4070C	OP4070CN
110	107-109,5	30	80	OP3080C	OP3080CN
115	112-114,5	50	65	OP5065C	OP5065CN
115	112-114,5	40	75	OP4075C	OP4075CN
120	117-119,5	60	60	OP6060C	OP6060CN
120	117-119,5	50	70	OP5070C	OP5070CN
120	117-119,5	40	80	OP4080C	OP4080CN
125	122-124,5	60	65	OP6065C	OP6065CN
125	122-124,5	50	75	OP5075C	OP5075CN
130	127-129,5	60	70	OP6070C	OP6070CN
130	127-129,5	50	80	OP5080C	OP5080CN
135	132-134,5	60	75	OP6075C	OP6075CN
140	137-139,5	60	80	OP6080C	OP6080CN

*Esempi: 100 (30+70) x70 (20+50) + braccetti = OP3070C + OP2050C + 1715 + 1715

OPEN COMBI | 2 porte a battente



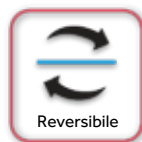

COMBI COMBINAZIONI SIMMETRICHE

Cm	Estensibilità (cm)	Apertura	● CROMO	● NERO
80 (40+40)	77-80	66	OP4040IR	-
80 (40+40)	79-82	66	OP4040I	-
90 (45+45)	87-90	76	OP4545IR	-
90 (45+45)	89-92	76	OP4545I	-
100 (50+50)	97-100	86	OP5050IR	OP5050INR
100 (50+50)	99-102	86	OP5050I	OP5050IN
110 (55+55)	107-110	96	OP5555IR	OP5555INR
110 (55+55)	109-112	96	OP5555I	OP5555IN
120 (60+60)	117-120	106	OP6060IR	OP6060INR
120 (60+60)	119-122	106	OP6060I	OP6060IN
130 (65+65)	127-130	116	OP6565IR	OP6565INR
130 (65+65)	129-132	116	OP6565I	OP6565IN
140 (70+70)	137-140	126	OP7070IR	OP7070INR
140 (70+70)	139-142	126	OP7070I	OP7070IN
150 (75+75)	147-150	136	OP7575IR	OP7575INR
150 (75+75)	149-152	136	OP7575I	OP7575IN
160 (80+80)	157-160	146	OP8080IR	OP8080INR
160 (80+80)	159-162	146	OP8080I	OP8080IN
170 (85+85)	167-170	156	OP8585IR	OP8585INR
170 (85+85)	169-172	156	OP8585I	OP8585IN

*Permette unione con laterale fisso STD con art. 1222/9015 (estensibilità minima +1,8/ espansione 1,5), vedi pag. 198. I riferimenti che terminano con R utilizzano il profilo art. 1215/9014, mentre gli altri utilizzano art. 1211/9012.

COMBI COMBINAZIONI ASIMMETRICHE

Cm	Estensibilità (cm)	Apertura	● CROMO	● NERO
85 (40+45)	84-87	71	OP4045I	-
95 (45+50)	94-97	81	OP4550I	-
105 (50+55)	104-107	91	OP5055I	OP5055IN
115 (55+60)	114-117	101	OP5560I	OP5560IN
125 (60+65)	124-127	111	OP6065I	OP6065IN
135 (65+70)	134-137	121	OP6570I	OP6570IN
145 (70+75)	144-147	131	OP7075I	OP7075IN
155 (75+80)	154-157	141	OP7580I	OP7580IN
165 (80+85)	164-167	151	OP8085I	OP8085IN

Descrizione	● CROMO	● NERO
Profilo espansione laterale porta +2,5 cm, vedi pag. 295	1222	9015
Magnete espansione +1,2 cm, vedi pag. 295	1221	
Opzione apertura IN-OUT 180°	1213	

OPEN COMBI J 2 porte a battente + fisso



PASSO 1 - Selezionare il supporto

Descrizione	 CROMO	 NERO
Braccio regolabile/girevole 60 cm	1715	1715N
Barra parallela con un supporto (fino 140 cm)	1716	9026
Barra parallela con un supporto (fino 200 cm)	1717	9027



1715



1716

PASSO 2 - Selezione combi J (fisso+porta+porta)

Cm F+P+P	Estensibilità (cm)	Apert.	CROMO	NERO
95(20+40+40)	94,8-98,8	66	OP204040J	-
100(25+40+40)	99,8-103,8	66	OP254040J	-
105(30+40+40)	104,8-108,8	66	OP304040J	-
110(25+45+45)	109,8-113,8	76	OP254545J	-
115(40+40+40)	114,8-118,8	66	OP404040J	-
115(30+45+45)	114,8-118,8	76	OP304545J	-
115(20+50+50)	114,8-118,8	86	OP205050J	OP205050JN
120(25+50+50)	119,8-123,8	86	OP255050J	OP255050JN
125(50+40+40)	124,8-128,8	66	OP504040J	-
125(30+50+50)	124,8-128,8	86	OP305050J	OP305050JN
130(25+55+55)	129,8-133,8	96	OP255555J	OP255555JN
135(60+40+40)	134,8-138,8	66	OP604040J	-
135(40+50+50)	134,8-138,8	86	OP405050J	OP405050JN
135(30+55+55)	134,8-138,8	96	OP305555J	OP305555JN
140(25+60+60)	139,8-143,8	106	OP256060J	OP256060JN
145(50+50+50)	144,8-148,8	86	OP505050J	OP505050JN
145(40+55+55)	144,8-148,8	96	OP405555J	OP405555JN
145(30+60+60)	144,8-148,8	106	OP306060J	OP306060JN
150(25+65+65)	149,8-153,8	116	OP256565J	OP256565JN
155(60+50+50)	154,8-158,8	86	OP605050J	OP605050JN
155(50+55+55)	154,8-158,8	96	OP505555J	OP505555JN
155(40+60+60)	154,8-158,8	106	OP406060J	OP406060JN
160(25+70+70)	159,8-163,8	126	OP257070J	OP257070JN
165(60+55+55)	164,8-168,8	96	OP605555J	OP605555JN
165(50+60+60)	164,8-168,8	106	OP506060J	OP506060JN
165(40+65+65)	164,8-168,8	116	OP406565J	OP406565JN
170(25+75+75)	169,8-173,8	136	OP257575J	OP257575JN
175(60+60+60)	174,8-178,8	106	OP606060J	OP606060JN
175(50+65+65)	174,8-178,8	116	OP506565J	OP506565JN
175(40+70+70)	174,8-178,8	126	OP407070J	OP407070JN
180(25+80+80)	179,8-183,8	146	OP258080J	OP258080JN
185(60+65+65)	184,8-188,8	116	OP606565J	OP606565JN
185(50+70+70)	184,8-188,8	126	OP507070J	OP507070JN
185(40+75+75)	184,8-188,8	136	OP407575J	OP407575JN
190(25+85+85)	189,8-193,8	156	OP258585J	OP258585JN
195(60+70+70)	194,8-198,8	126	OP607070J	OP607070JN
195(50+75+75)	194,8-198,8	136	OP507575J	OP507575JN
195(40+80+80)	194,8-198,8	146	OP408080J	OP408080JN
205(60+75+75)	204,8-208,8	136	OP607575J	OP607575JN
205(50+80+80)	204,8-208,8	146	OP508080J	OP508080JN
205(40+85+85)	204,8-208,8	156	OP408585J	OP408585JN
215(60+80+80)	214,8-218,8	146	OP608080J	OP608080JN
215(50+85+85)	214,8-218,8	156	OP508585J	OP508585JN

*Permette combinazione con laterale fisso STD nel lato della porta usando art.1222, estensibilità minima +0,7 +1,8 / espansione 2,5 cm, vedi pag. 198.

*Permette uso profilo di compensazione in entrambi i lati

Descrizione	CROMO	NERO
Profilo porta (riduce fino 1 cm l'estensione), vedi pag. 295	1215	9014
Profilo espansione laterale porta +2,5 cm, vedi pag. 295	1222	9015
Magnete espansione +1,2 cm, vedi pag. 295	1221	



Pannelli fissi
su misura
(vedi pag. 289)

OPEN COMBI K 2 porte angolari



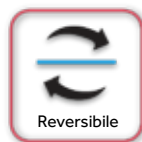

COMBI K

Cm P+P	Estensibilità (cm)	Apert.	● CROMO	● NERO
40x40	40,4-41,9 / 40,4-41,9	66	OP4040K	-
40x45	40,4-41,9 / 45,4-46,9	76	OP4045K	-
45x45	45,4-46,9 / 45,4-46,9	76	OP4545K	-
45x50	45,4-46,9 / 50,4-51,9	86	OP4550K	-
45x55	45,4-46,9 / 55,4-56,9	96	OP4555K	-
45x60	45,4-46,9 / 60,4-61,9	106	OP4560K	-
45x65	45,4-46,9 / 65,4-66,9	116	OP4565K	-
45x70	45,4-46,9 / 70,4-71,9	126	OP4570K	-
45x75	45,4-46,9 / 75,4-76,9	136	OP4575K	-
45x80	45,4-46,9 / 80,4-81,9	146	OP4580K	-
50x50	50,4-51,9 / 50,4-51,9	86	OP5050K	OP5050KN
50x55	50,4-51,9 / 55,4-56,9	96	OP5055K	OP5055KN
50x60	50,4-51,9 / 60,4-61,9	106	OP5060K	OP5060KN
50x65	50,4-51,9 / 65,4-66,9	116	OP5065K	OP5065KN
50x70	50,4-51,9 / 70,4-71,9	126	OP5070K	OP5070KN
50x75	50,4-51,9 / 75,4-76,9	136	OP5075K	OP5075KN
50x80	50,4-51,9 / 80,4-81,9	146	OP5080K	OP5080KN
55x55	55,4-56,9 / 55,4-56,9	96	OP5555K	OP5555KN
55x60	55,4-56,9 / 60,4-61,9	106	OP5560K	OP5560KN
55x65	55,4-56,9 / 65,4-66,9	116	OP5565K	OP5565KN
55x70	55,4-56,9 / 70,4-71,9	126	OP5570K	OP5570KN
55x75	55,4-56,9 / 75,4-76,9	136	OP5575K	OP5575KN
55x80	55,4-56,9 / 80,4-81,9	146	OP5580K	OP5580KN
60x60	60,4-61,9 / 60,4-61,9	106	OP6060K	OP6060KN
60x65	60,4-61,9 / 65,4-66,9	116	OP6065K	OP6065KN
60x70	60,4-61,9 / 70,4-71,9	126	OP6070K	OP6070KN
60x75	60,4-61,9 / 75,4-76,9	136	OP6075K	OP6075KN
60x80	60,4-61,9 / 80,4-81,9	146	OP6080K	OP6080KN
65x65	65,4-66,9 / 65,4-66,9	116	OP6565K	OP6565KN
65x70	65,4-66,9 / 70,4-71,9	126	OP6570K	OP6570KN
65x75	65,4-66,9 / 75,4-76,9	136	OP6575K	OP6575KN
65x80	65,4-66,9 / 80,4-81,9	146	OP6580K	OP6580KN
70x70	70,4-71,9 / 70,4-71,9	126	OP7070K	OP7070KN
70x75	70,4-71,9 / 75,4-76,9	136	OP7075K	OP7075KN
70x80	70,4-71,9 / 80,4-81,9	146	OP7080K	OP7080KN
75x75	75,4-76,9 / 75,4-76,9	136	OP7575K	OP7575KN
75x80	75,4-76,9 / 80,4-81,9	146	OP7580K	OP7580KN
80x80	80,4-81,9 / 80,4-81,9	146	OP8080K	OP8080KN
80x85	80,4-81,9 / 85,4-86,9	156	OP8085K	OP8085KN
85x85	85,4-86,9 / 85,4-86,9	156	OP8585K	OP8585KN

*Permette uso profilo di compensazione in entrambi i lati

*I riferimenti della tabella includono il profilo art. 1211

Descrizione	● CROMO	● NERO
Profilo porta (riduce fino 1 cm l'estensione), vedi pag. 295	1215	9014
Profilo espansione laterale porta +2,5 cm, vedi pag. 295	1222	9015



COMBI A FROST

Estensibilità (cm)	Apert.	Art.
50,1-51,6	43	OP50ASR
51,1-52,6	43	OP50AS
55,1-56,6	48	OP55ASR
56,1-57,6	48	OP55AS
60,1-61,6	53	OP60ASR
61,1-62,6	53	OP60AS
65,1-66,6	58	OP65ASR
66,1-67,6	58	OP65AS
70,1-71,6	63	OP70ASR
71,1-72,6	63	OP70AS
75,1-76,6	68	OP75ASR
76,1-77,6	68	OP75AS
80,1-81,6	73	OP80ASR
81,1-82,6	73	OP80AS
85,1-86,6	78	OP85ASR
86,1-87,6	78	OP85AS

Permette unione con laterali fissi STD nel lato della porta usando Art. 1222 (estensione minima +1,8 cm), vedi pag. 198
I riferimenti che terminano con R utilizzano il profilo art. 1215, mentre gli altri utilizzano art. 1211.

COMBI B FROST

Estensibilità (cm)	Apert.	Art.
52,6-56,6	43	OP55BSR
53,6-57,6	43	OP55BS
57,6-61,6	48	OP60BSR
58,6-62,6	48	OP60BS
62,6-66,6	53	OP65BSR
63,6-67,6	53	OP65BS
67,6-71,6	58	OP70BSR
68,6-72,6	58	OP70BS
72,6-76,6	63	OP75BSR
73,6-77,6	63	OP75BS
77,6-81,6	68	OP80BSR
78,6-82,6	68	OP80BS
82,6-86,6	73	OP85BSR
83,6-87,6	73	OP85BS
87,6-91,6	78	OP90BS
88,6-92,6	78	OP90BSR

Permette unione con laterali fissi STD nel lato profilo a chiusura magnetica (estensione minima +0,7 cm, espansione +1,5 cm), vedi pag. 198
Permette unione con laterali fissi STD nel lato porta usando art. 1222 (estensione minima +1,8 cm, espansione +2,5 cm), vedi pag. 198
I riferimenti che terminano con R utilizzano il profilo art. 1215, mentre gli altri utilizzano art. 1211.

Descrizione.	Art.
Profilo espansione lato profilo a chiusura magnetica +3 cm	0218
Magnete espansione +1,2 cm, vedi pag. 295	1221
Profilo espansione laterale porta +2,5 cm, vedi pag. 295	1222
Opzione apertura IN-OUT 180°	1213



Opzione barra parallela art. 1716



PASSO 1 - Selezionare il supporto

Descrizione	CROMO	NERO
Braccio regolabile/girevole 60 cm	1715	1715N
Barra parallela con un supporto (fino 140 cm)	1716	9026

PASSO 2 - COMBI C FROST

Cm	Estensibilità	Art.
80 (30+50)	77,5-80	OP3050CS
85 (30+55)	82,5-85	OP3055CS
90 (30+60)	87,5-90	OP3060CS
90 (40+50)	87,5-90	OP4050CS
95 (30+65)	92,5-95	OP3065CS
95 (40+55)	92,5-95	OP4055CS
100 (30+70)	97,5-100	OP3070CS
100 (40+60)	97,5-100	OP4060CS
105 (30+75)	102,5-105	OP3075CS
105 (40+65)	102,5-105	OP4065CS
110 (30+80)	107,5-110	OP3080CS
110 (40+70)	107,5-110	OP4070CS
110 (50+60)	107,5-110	OP5060CS
115 (30+85)	112,5-115	OP3085CS
115 (40+75)	112,5-115	OP4075CS
115 (50+65)	112,5-115	OP5065CS
120 (40+80)	117,5-120	OP4080CS
120 (50+70)	117,5-120	OP5070CS
125 (40+85)	122,5-125	OP4085CS
125 (50+75)	122,5-125	OP5075CS
125 (60+65)	122,5-125	OP6065CS
130 (50+80)	127,5-130	OP5080CS
130 (60+70)	127,5-130	OP6070CS
135 (50+85)	132,5-135	OP5085CS
135 (60+75)	132,5-135	OP6075CS
140 (60+80)	137,5-140	OP6080CS
145 (60+85)	142,5-145	OP6085CS

*Permette combinazione con laterale fisso STD nel lato fisso, estensione minima +0,7 (non regolabile), vedi pag. 198

PASSO 2 - COMBI D FROST

Cm	Estensibilità	Art.
85 (30+50)	80-85	OP3050DS
90 (30+55)	85-90	OP3055DS
95 (30+60)	90-95	OP3060DS
95 (40+50)	90-95	OP4050DS
100 (30+65)	95-100	OP3065DS
100 (40+55)	95-100	OP4055DS
105 (30+70)	100-105	OP3070DS
105 (40+60)	100-105	OP4060DS
110 (30+75)	105-110	OP3075DS
110 (40+65)	105-110	OP4065DS
115 (30+80)	110-115	OP3080DS
115 (40+70)	110-115	OP4070DS
115 (50+60)	110-115	OP5060DS
120 (30+85)	115-120	OP3085DS
120 (40+75)	115-120	OP4075DS
120 (50+65)	115-120	OP5065DS
125 (40+80)	120-125	OP4080DS
125 (50+70)	120-125	OP5070DS
130 (40+85)	125-130	OP4085DS
130 (50+75)	125-130	OP5075DS
130 (60+65)	125-130	OP6065DS
135 (50+80)	130-135	OP5080DS
135 (60+70)	130-135	OP6070DS
140 (50+85)	135-140	OP5085DS
140 (60+75)	135-140	OP6075DS
145 (60+80)	140-145	OP6080DS
150 (60+85)	145-150	OP6085DS

*Permette combinazione con laterale fisso STD, estensibilità minima +0,7 / espansione 2,5 cm vedi pag. 198

OPEN FROST PLUS COMBI A + lat. fisso

Apertura esterna
90° p/fisso



Opzione in-out
0180° p/fisso



L'estensibilità del frontale con apertura in-out aumenterà di 1,4 cm e l'estensibilità del laterale fisso si riduce di 1 cm.

Art. 0038

Opzioni accessorie

Descrizione	Art.
Profilo espansione +2 cm	0218
Profilo espansione +4 cm	0029

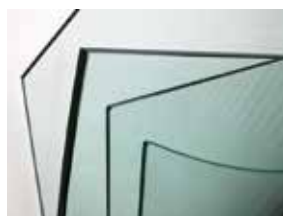

Lati fissi su misura **6 mm**

FROST PLUS

Descrizione

Art.

Laterale fisso su misura fino 40 cm

1345+1312

Laterale fisso su misura da 40 fino 80 cm

1316+1313

Laterale fisso su misura da 80 fino 120 cm

1317+1315

*Tempo di consegna 3 settimane. Altre informazioni vedi pag. 291



PASSO 1 - Selezione misura frontale (porta)

Estensibilità (cm)	Apertura	Art.
49,6-51,1	43	OP50ASR
50,6-52,1	43	OP50AS
54,6-56,1	48	OP55ASR
55,6-57,1	48	OP55AS
59,6-61,1	53	OP60ASR
60,6-62,1	53	OP60AS
64,6-66,1	58	OP65ASR
65,6-67,1	58	OP65AS
69,6-71,1	63	OP70ASR
70,6-72,1	63	OP70AS
74,6-76,1	68	OP75ASR
75,6-77,1	68	OP75AS
79,6-81,1	73	OP80ASR
80,6-82,1	73	OP80AS
84,6-86,1	78	OP85ASR
85,6-87,1	78	OP85AS

*Permette unione con laterali fissi STD nel lato della porta usando Art. 1222 (estensione minima +1,8 cm), vedi pag. 198

PASSO 2 - Selezione misura lat. fisso

Estensibilità (cm)	Art.
66-69	1292
76-79	1293
86-89	1294

PASSO 3 - Selezionare il supporto

Descrizione	Art.
Braccio regolabile/girevole 60 cm	1715
Barra parallela + supporto fino a 140 cm	1716+1718



OPEN FROST PLUS COMBI C + lat. fisso

Apertura esterna
90° p/fisso



Opzione in-out
0180° p/fisso



L'estensibilità del frontale con apertura in-out aumenterà di 1,4 cm e l'estensibilità del laterale fisso si riduce di 1 cm.

Art. 0038

Opzioni accessorie

Descrizione	Art.
Profilo espansione +2 cm	0218
Profilo espansione +4 cm	0029

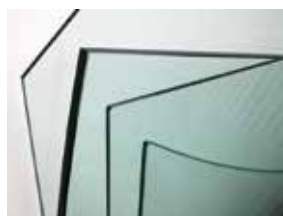

Lati fissi su misura **6 mm**

FROST PLUS

Descrizione

Art.

Laterale fisso su misura fino 40 cm

1345+1312

Laterale fisso su misura da 40 fino 80 cm

1316+1313

Laterale fisso su misura da 80 fino 120 cm

1317+1315

*Tempo di consegna 3 settimane. Altre informazioni vedi pag. 291

PASSO 1 - Selezione misura frontale (fisso+porta)

Cm	Estensibilità (cm)	Art.
80 (30+50)	77,5-80	OP3050CS
85 (30+55)	82,5-85	OP3055CS
90 (30+60)	87,5-90	OP3060CS
90 (40+50)	87,5-90	OP4050CS
95 (30+65)	92,5-95	OP3065CS
95 (40+55)	92,5-95	OP4055CS
100 (30+70)	97,5-100	OP3070CS
100 (40+60)	97,5-100	OP4060CS
100 (50+50)	97,5-100	OP5050CS
105 (30+75)	102,5-105	OP3075CS
105 (40+65)	102,5-105	OP4065CS
105 (50+55)	102,5-105	OP5055CS
110 (30+80)	107,5-110	OP3080CS
110 (40+70)	107,5-110	OP4070CS
110 (50+60)	107,5-110	OP5060CS
110 (60+50)	107,5-110	OP6050CS
115 (30+85)	112,5-115	OP3085CS
115 (40+75)	112,5-115	OP4075CS
115 (50+65)	112,5-115	OP5065CS
115 (60+55)	112,5-115	OP6055CS
120 (40+80)	117,5-120	OP4080CS
120 (50+70)	117,5-120	OP5070CS
120 (60+60)	117,5-120	OP6060CS
125 (40+85)	122,5-125	OP4085CS
125 (50+75)	122,5-125	OP5075CS
125 (60+65)	122,5-125	OP6065CS
130 (50+80)	127,5-130	OP5080CS
130 (60+70)	127,5-130	OP6070CS
135 (50+85)	132,5-135	OP5085CS
135 (60+75)	132,5-135	OP6075CS
140 (60+80)	137,5-140	OP6080CS
145 (60+85)	142,5-145	OP6085CS

*Permette unione con laterali fissi STD nel lato della porta utilizzando Art. 1222 (estensione minima +1,8 cm), vedi pag. 198

PASSO 2 - Selezione misura lat. fisso

Estensibilità (cm)	Art.
66-69	1292
76-79	1293
86-89	1294

PASSO 3 - Selezionare il supporto

Descrizione	Art.
Braccio regolabile/girevole 60 cm	1715+1715
Barra parallela + supporto fino a 140 cm	1716+1718





COMBI G FROST

PASSO 1 - Selezione misura combi G

Cm	Estensibilità	Art.
155 (30+50+50+30)	151,2/156,2	OP30505030GS
165 (30+55+55+30)	161,2/166,2	OP30555530GS
175 (40+50+50+40)	171,2/176,2	OP40505040GS
175 (30+60+60+30)	171,2/176,2	OP30606030GS
185 (40+55+55+40)	181,2/186,2	OP40555540GS
185 (30+65+65+30)	181,2/186,2	OP30656530GS
195 (50+50+50+50)	191,2/196,2	OP50505050GS
195 (40+60+60+40)	191,2/196,2	OP40606040GS
195 (30+70+70+30)	191,2/196,2	OP30707030GS
205 (50+55+55+50)	201,2/206,2	OP50555550GS
205 (40+65+65+40)	201,2/206,2	OP40656540GS
205 (30+75+75+30)	201,2/206,2	OP30757530GS
215 (60+50+50+60)	211,2/216,2	OP60505060GS
215 (50+60+60+50)	211,2/216,2	OP50606050GS
215 (40+70+70+40)	211,2/216,2	OP40707040GS
215 (30+80+80+30)	211,2/216,2	OP30808030GS
225 (60+55+55+60)	221,2/226,2	OP60555560GS
225 (50+65+65+50)	221,2/226,2	OP50656550GS
225 (40+75+75+40)	221,2/226,2	OP40757540GS
225 (30+85+85+30)	221,2/226,2	OP30858530GS
235 (60+60+60+60)	231,2/236,2	OP60606060GS
235 (50+70+70+50)	231,2/236,2	OP50707050GS
235 (40+80+80+40)	231,2/236,2	OP40808040GS
245 (60+65+65+60)	241,2/246,2	OP60656560GS
245 (50+75+75+50)	241,2/246,2	OP50757550GS
245 (40+85+85+40)	241,2/246,2	OP40858540GS
255 (60+70+70+60)	251,2/256,2	OP60707060GS
255 (50+80+80+50)	251,2/256,2	OP50808050GS
265 (60+75+75+60)	261,2/266,2	OP60757560GS
265 (50+85+85+50)	261,2/266,2	OP50858550GS
275 (60+80+80+60)	271,2/276,2	OP60808060GS
285 (60+85+85+60)	281,2/286,2	OP60858560GS

PASSO 2 - Selezionare il supporto

Descrizione	Art.
Braccetto regolab./girev. 60 cm	1715+1715
Barra parallela 200 cm	1717

*Permette unione con laterale fisso STD in entrambi i lati (estensione minima +0,7 cm / regolazione 2,5 cm), vedi pag. 198

*Permette uso profilo di compensazione in entrambi i lati



Descrizione	Art.
Profilo espansione +3 cm	0218
Profilo espansione +6 cm	0029
Magnete espansione +1,2 cm	1221



Pannelli fissi
su misura
(vedi pag. 289)



COMBI H FROST

PASSO 1 - Selezione 2 lati del box doccia

Cm	Estensibilità (cm)	Art.
80 (30+50)	77,5-80	OP3050CS
85 (30+55)	82,5-85	OP3055CS
90 (30+60)	87,5-90	OP3060CS
90 (40+50)	87,5-90	OP4050CS
95 (30+65)	92,5-95	OP3065CS
95 (40+55)	92,5-95	OP4055CS
100 (30+70)	97,5-100	OP3070CS
100 (40+60)	97,5-100	OP4060CS
100 (50+50)	97,5-100	OP5050CS
105 (30+75)	102,5-105	OP3075CS
105 (40+65)	102,5-105	OP4065CS
105 (50+55)	102,5-105	OP5055CS
110 (30+80)	107,5-110	OP3080CS
110 (40+70)	107,5-110	OP4070CS
110 (50+60)	107,5-110	OP5060CS
110 (60+50)	107,5-110	OP6050CS
115 (30+85)	112,5-115	OP3085CS
115 (40+75)	112,5-115	OP4075CS
115 (50+65)	112,5-115	OP5065CS
115 (60+55)	112,5-115	OP6055CS
120 (40+80)	117,5-120	OP4080CS
120 (50+70)	117,5-120	OP5070CS
120 (60+60)	117,5-120	OP6060CS
125 (40+85)	122,5-125	OP4085CS
125 (50+75)	122,5-125	OP5075CS
125 (60+65)	122,5-125	OP6065CS
130 (50+80)	127,5-130	OP5080CS
130 (60+70)	127,5-130	OP6070CS
135 (50+85)	132,5-135	OP5085CS
135 (60+75)	132,5-135	OP6075CS
140 (60+80)	137,5-140	OP6080CS
145 (60+85)	142,5-145	OP6085CS

PASSO 2 - Selezionare il supporto

Descrizione	Art.
Braccetto regolabile/girevole 60 cm	1715+1715
Barra parallela fino a 140 cm	1716+1716+1730

*Permette uso profilo di compensazione in entrambi i lati
Esempi: 100x80 = OP4060CS+OP3050CS+1715+1715

Descrizione	Art.
Profilo espansione +3 cm	0218
Profilo espansione +6 cm	0029



Pannelli fissi
su misura
(vedi pag. 289)

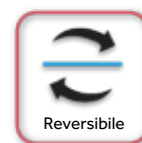



COMBI I FROST

COMBINAZIONI SIMMETRICHE

Estensibilità	Apertura	Art.
97-100	86	OP5050ISR
99-102	86	OP5050IS
107-110	96	OP5555ISR
109-112	96	OP5555IS
117-120	106	OP6060ISR
119-122	106	OP6060IS
127-130	116	OP6565ISR
129-132	116	OP6565IS
137-140	126	OP7070ISR
139-142	126	OP7070IS
147-150	136	OP7575ISR
149-152	136	OP7575IS
157-160	146	OP8080ISR
159-162	146	OP8080IS
167-170	156	OP8585ISR
169-172	156	OP8585IS

COMBI I FROST

COMBINAZIONI ASIMMETRICHE

Estensibilità	Apertura	Art.
104-107	111	OP6065IS
114-117	116	OP6570IS
124-127	121	OP7075IS
134-137	126	OP7580IS
144-147	131	OP8085IS
154-157	136	OP6060IS
164-167	141	OP6565ISR

*Permette unione con laterale fisso STD con art. 1222 (estensibilità minima +1,8/ espansione 1,5), vedi pag. 198
I riferimenti che terminano con R utilizzano il profilo art. 1215, mentre gli altri utilizzano art. 1211.

Descrizione	Art.
Profilo espansione porte +2,5 cm	1222
Magnete espansione +1,2 cm	1221

PROGRAMMA MODULARE OPEN

Fissi

Estensibilità (cm)	TRASPARENTE		FROST PLUS
	CROMO	NERO	Art.
17,5/20	1200	9024	-
22,5/25	1201	9025	-
27,5/30	1202	9000	1280
37,5/40	1203	9001	1281
47,5/50	1204	9002	1282
57,5/60	1205	9003	1283

(2,5 regolazione) *Non include il braccetto

Profili standard

Descrizione	CROMO	NERO
Profilo della parete Open	1211	9012
Profilo di chiusura con magnete	1212	9013
Profilo porta riduce 1 cm l'estensione	1215	9014

Porte

Pta.	TRASPARENTE		FROST P.	A,E +1211	B +1211 +1212	C,F	D +1212	G	H	I +1211x2	J +1211
	CR	NG	Art.								
40x2	1206	-	-								
40	1216	-	-	41,1/42,6	43,6/47,6	40	42,5/45	38,1	39,5	39,5/41	38,6/39,5
45	1217	-	-	46,1/47,6	48,6/52,6	45	47,5/50	43,1	44,5	44,5/46	43,6/44,3
50	1207	9004	1284	51,1/52,6	53,6/57,6	50	52,5/55	48,1	49,5	49,5/51	48,6/49,3
55	1218	9005	1285	56,1/57,6	58,6/62,6	55	57,5/60	53,1	54,5	54,5/56	53,6/54,3
60	1219	9006	1286	61,1/62,6	63,6/67,6	60	62,5/65	58,1	59,5	59,5/61	58,6/59,3
65	1208	9007	1287	66,1/67,6	68,6/72,6	65	67,5/70	63,1	64,5	64,5/66	63,6/64,3
70	1209	9008	1288	71,1/72,6	73,6/77,6	70	72,5/75	68,1	69,5	69,5/71	68,6/69,3
75	1220	9009	1289	76,1/77,6	78,6/82,6	75	77,5/80	73,1	74,5	74,5/76	73,6/74,3
80	1210	9010	1290	81,1/82,6	83,6/87,6	80	82,5/85	78,1	79,5	79,5/81	78,6/79,3
85	1223	9011	1291	86,1/87,6	88,6/92,6	85	87,5/90	83,1	84,5	84,5/86	83,6/84,3

Lati fissi

Descrizione	Art.
Cristallo laterale fisso 70	1760
Cristallo laterale fisso 80	1761
Cristallo laterale fisso 90	1762
Descrizione	Art.
Profilo della parete cromo	5429
Profilo della parete nero	5477

Lati fissi Frost

Descrizione	Art.
Laterale fisso da 70 frost	1292
Laterale fisso da 80 frost	1293
Laterale fisso da 90 frost	1294

CONFIGURATE LE VOSTRE ESIGENZE NEL NOSTRO B2B

b2b.gmelorente.com

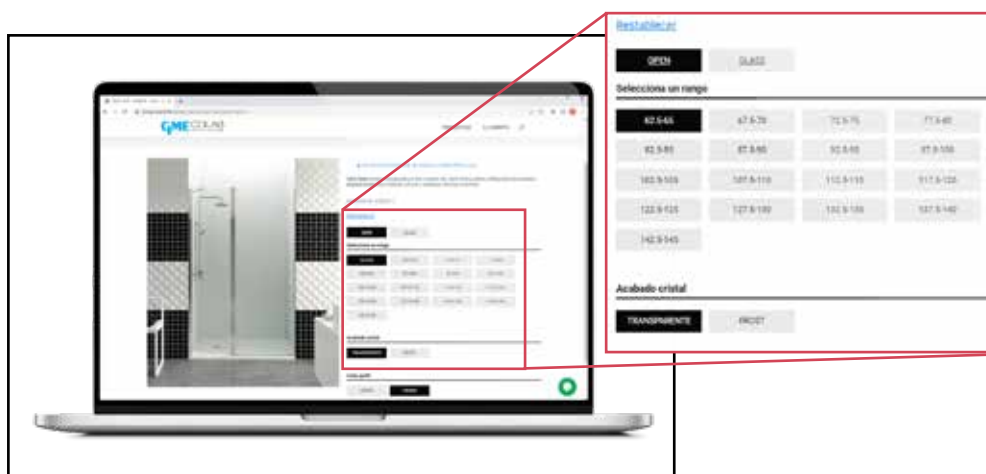

OPEN/GLASS

Laterale fisso STD Trasparente

A pannello
fisso

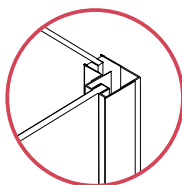

A chiusura
profilo magnetico

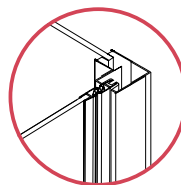

A porta
battente

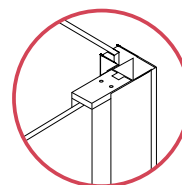

Combi E 30+70 + lat. fisso STD 70
Art. 1202+1209+1211+0814+1715+1715



Se l'unione è nel lato fisso o nel profilo a chiusura magnetica art. 1212, si sommerà +0,7 cm all'estensione minima della combinazione + espansione del lato libero del laterale fisso. L'espansione nel lato in cui va il laterale fisso si perde.

Se l'unione è nel lato della porta si deve utilizzare art. 1222, si sommeranno +1,8 cm all'estensione minima della combinazione + espansione nel lato libero del laterale fisso.

Disponibile per combinazioni

COMBI A
Lato
profilo
porta



COMBI B
Entrambi
lati

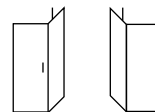

COMBI C
Lato fisso

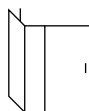

COMBI D
Entrambi
lati

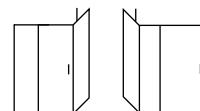

COMBI E
Entrambi
lati

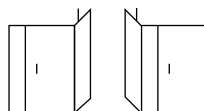

COMBI F
Entrambi
lati

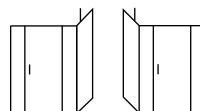

COMBI G
Entrambi
lati

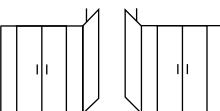

COMBI I
Entrambi
lati

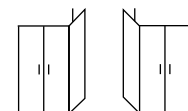

COMBI J
Entrambi
lati

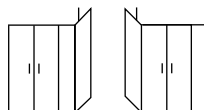

Lati fissi STD TRASPARENTES 8 mm

Descrizione	Cm	Art.
Lat. fisso STD 30x195 + braccetto	26-29	0810+1715
Lat. fisso STD 40x195 + braccetto	36-39	0811+1715
Lat. fisso STD 50x195 + braccetto	46-49	0812+1715
Lat. fisso STD 60x195 + braccetto	56-59	0813+1715
Lat. fisso STD 70x195 + braccetto	66-69	0814+1715
Lat. fisso STD 75x195 + braccetto	71-74	0820+1715
Lat. fisso STD 80x195 + braccetto	76-79	0815+1715
Lat. fisso STD 90x195 + braccetto	86-89	0816+1715



Opzione barra parallela 140 cm art. 1716+1718+5568 (si esclude braccetto 1715)
Opzione barra parallela 200 cm art. 1717+1718+5568 (si esclude braccetto 1715)

Descrizione	Art.
Profilo espansione +2 cm	0218
Profilo espansione +4 cm	0029



Lati fissi su misura STD TRASPARENTE 8 mm (maggiori informazioni a pagina 290)

Descrizione	Art.
Laterale fisso su misura fino 40 cm + braccetto	1343+1715
Laterale fisso su misura da 40 fino 80 cm + braccetto	1304+1715
Laterale fisso su misura da 80 fino 120 cm + braccetto	1310+1715

*Tempo di consegna 3 settimane

OPEN

Laterale fisso STD Frost Plus

A pannello
fisso

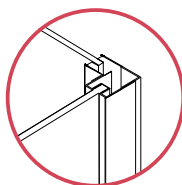

A chiusura
profilo magnetico

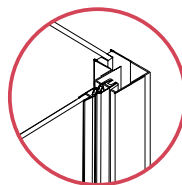

A porta
battente

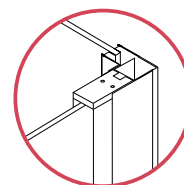

Combi C Frost 30+70 + lat. fisso Frost STD 70 + barra parallela
Art. 1280+1288+1211+0817+1716+1718+5568



Se l'unione è nel lato fisso o nel profilo a chiusura magnetica art. 1212, si sommerà +0,7 cm all'estensione minima della combinazione + espansione del lato libero del laterale fisso. L'espansione nel lato in cui va il laterale fisso si perde.

Se l'unione è nel lato della porta si deve utilizzare art. 1222, si sommeranno +1,8 cm all'estensione minima della combinazione + espansione nel lato libero del laterale fisso.

Disponibile per combinazioni

COMBI A
Lato
profilo
porta



COMBI B
Entrambi
i lati

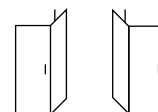

COMBI C
Lato fisso

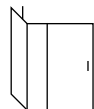

COMBI D
Entrambi
i lati

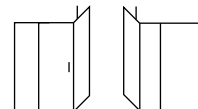

COMBI G
Entrambi
i lati

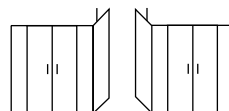

COMBI I
Entrambi
i lati

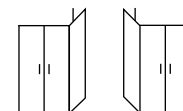

COMBI J
Entrambi
i lati

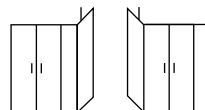

Lati fissi STD FROST PLUS 8 mm

Descrizione	Est.	Art.
Lat. fisso STD 70x195 + braccetto	66-69	0817+1715
Lat. fisso STD 80x195 + braccetto	76-79	0818+1715
Lat. fisso STD 90x195 + braccetto	86-89	0819+1715



Descrizione	Art.
Profilo espansione +2 cm	0218
Profilo espansione +4 cm	0029



Lati fissi su misura STD FROST PLUS 8 mm (maggiori informazioni a pagina 290)

Descrizione	Art.
Lat. fisso su misura fino 40 cm + braccetto	1343+1312+1715
Lat. fisso su misura da 40 fino 80 cm + braccetto	1304+1313+1715
Lat. fisso su misura da 80 fino 120 cm + braccetto	1310+1315+1715

*Tempo di consegna 3 settimane

glass

“Soluzioni per ogni spazio con l’eleganza delle porte a battente e pieghevoli.”

-  CROMO
-  NERO
-  ORO
-  NICHEL
-  TITANIO
-  RAME
-  BIANCO





CERNIERE

GLASS CERNIERA A PARETE



Descrizione	Estensibilità	Apertura	● CROMO	● NERO	● BIANCO
Combi 1 65	65,1	59	GL65A	GL65AN	GL65ABL
Combi 2 65	67,6-70,1	59	GL65B	GL65BN	GL65BBL
Combi 1 70	70,1	64	GL70A	GL70AN	GL70ABL
Combi 2 70	72,6-75,1	64	GL70B	GL70BN	GL70BBL
Combi 1 80	80,1	74	GL80A	GL80AN	GL80ABL
Combi 2 80	82,6-85,1	74	GL80B	GL80BN	GL80BBL
Porta su misura 60 fino 80 cm (consegna 3 settimane)			1338CR	1338N	1338BL
Profilo espansione +2cm (solo Combi 2)			0218	9016	0218BL
Magnete espansione +1,2 cm			1221		

Combinazioni con laterale fisso vedi pagina 207

GLASS CERNIERA A PARETE

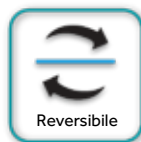

Descrizione	Estensibilità	Apertura	ORO	RAME	NICHEL	TITANIO
Combi 1 65	65,1	59	GL65AOR	GL65ACB	GL65ANK	GL65AT
Combi 2 65	67,6-70,1	59	GL65BOR	GL65BCB	GL65BNK	GL65BT
Combi 1 70	70,1	64	GL70AOR	GL70ACB	GL70ANK	GL70AT
Combi 2 70	72,6-75,1	64	GL70BOR	GL70BCB	GL70BNK	GL70BT
Combi 1 80	80,1	74	GL80AOR	GL80ACB	GL80ANK	GL80AT
Combi 2 80	82,6-85,1	74	GL80BOR	GL80BCB	GL80BNK	GL80BT
Porta su misura 60 fino 80 cm (consegna 3 set.)			1338OR	1338CB	1338NK	1338T
Profilo espansione +2cm (solo Combi 2)			0218OR	0218CB	0218NK	0218T
Magnete espansione +1,2 cm			1221			

GLASS CERNIERA AL PROFILO

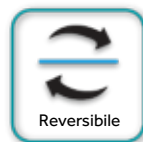

Descrizione	Estensibilità	Apertura	● CROMO	● NERO	● BIANCO
Combi A 65	68,2-70,2	59	GL65A	GL65AN	GL65ABL
Combi B 65	70,7-75,2	59	GL65B	GL65BN	GL65BBL
Combi A 70	73,2-75,2	64	GL70A	GL70AN	GL70ABL
Combi B 70	75,7-80,2	64	GL70B	GL70BN	GL70BBL
Combi A 80	83,2-85,2	74	GL80A	GL80AN	GL80ABL
Combi B 80	85,7-90,2	74	GL80B	GL80BN	GL80BBL
Profilo espansione +2cm (solo Combi B)			0218	9016	0218BL
Magnete espansione +1,2 cm			1221		

GLASS CERNIERA AL PROFILO

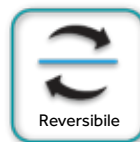

Descrizione	Estensibilità	Apertura	ORO	RAME	NICHEL	TITANIO
Combi A 65	68,2-70,2	59	GL65AOR	GL65ACB	GL65ANK	GL65AT
Combi B 65	70,7-75,2	59	GL65BOR	GL65BCB	GL65BNK	GL65BT
Combi A 70	73,2-75,2	64	GL70AOR	GL70ACB	GL70ANK	GL70AT
Combi B 70	75,7-80,2	64	GL70BOR	GL70BCB	GL70BNK	GL70BT
Combi A 80	83,2-85,2	74	GL80AOR	GL80ACB	GL80ANK	GL80AT
Combi B 80	85,7-90,2	74	GL80BOR	GL80BCB	GL80BNK	GL80BT
Profilo espansione +2cm (solo Combi B)			0218OR	0218CB	0218NK	0218T
Magnete espansione +1,2 cm			1221			

CERNIERE

GLASS COMBI A + Laterale fisso





PASSO 1 - Selezionare le dimensioni e il colore della porta

Estensibilità	Apert.	CROMO	NERO	BIANCO
67,7-69,7	60	GL65A	GL65AN	GL65ABL
72,7-74,7	65	GL70A	GL70AN	GL70ABL
82,7-84,7	70	GL80A	GL80AN	GL80ABL
Porta su misura 60 fino 80 cm (consegna 3 settimane)		1338CR	1338N	1338BL

PASSO 2 - Selezionare il lato fisso

Descrizione	Estensibilità	CROMO	NERO	BIANCO
Laterale fisso da 70 cm	66-69	1720CR	1720N	1720BL
Laterale fisso da 80 cm	76-79	1721CR	1721N	1721BL
Laterale fisso da 90 cm	86-89	1722CR	1722N	1722BL

PASSO 3 - Selezionare il supporto

Descrizione	CROMO	NERO	BIANCO
Braccetto regolabile 60 cm	1715	1715N	1715B
Barra fino a 140 cm con un supporto	1716+1718	9026+9028	1716BL+1718BL



Lati fissi su misura GLASS/OPEN 6 mm (maggiori informazioni a pagina 291)

Descrizione	CROMO	NERO	BIANCO
Larghezza < 40 cm	1345	1345N	1345B
Larghezza >40 e <80 cm	1316	1316N	1316B
Larghezza >80 e <120 cm	1317	1317N	1317B

*Non include il braccetto, tempo di consegna 3 settimane

GLASS COMBI A + Laterale fisso





PASSO 1 - Selezione misura e colore della porta

Estensibilità	Apert.	ORO	RAME	NICHEL	TITANIO
67,7-69,7	60	GL65AOR	GL65ACB	GL65ANK	GL65AT
72,7-74,7	65	GL70AOR	GL70ACB	GL70ANK	GL70AT
82,7-84,7	75	GL80AOR	GL80ACB	GL80ANK	GL80AT
Porta su misura 60 fino 80 cm (consegna 3 set.)		1338OR	1338CB	1338NK	1338T

PASSO 2 - Selezionare il lato fisso

Descrizione	Estensibilità	ORO	RAME	NICHEL	TITANIO
Laterale fisso da 70 cm	66-69	1720OR	1720CB	1720NK	1720T
Laterale fisso da 80 cm	76-79	1721OR	1721CB	1721NK	1721T
Laterale fisso da 90 cm	86-89	1722OR	1722CB	1722NK	1722T

PASSO 3 - Selezionare il supporto

Descrizione	ORO	RAME	NICHEL	TITANIO
Braccetto regolabile 60 cm	1715OR	1715CB	1715NK	1715T
Barra fino a 140 cm con un supporto	1716OR+1718OR	1716CB+1718CB	1716NK+1718NK	1716T+1718T



Lati fissi su misura GLASS/OPEN 6 mm (maggiori informazioni a pagina 291)

Descrizione	ORO	RAME	NICHEL	TITANIO
Larghezza < 40 cm	1345OR	1345CB	1345NK	1345T
Larghezza >40 e <80 cm	1316OR	1316CB	1316NK	1316T
Larghezza >80 e <120 cm	1317OR	1317CB	1317NK	1317T

*Non include il braccetto, tempo di consegna 3 settimane

GLASS COMBI C fisso + porta a battente con chiusura magnetica a parete



Cromo



Nero



Bianco



Chiusura a parete con magnete



Pannelli fissi e porte a misura vedi pag. 289

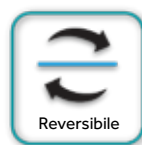

PASSO 1 - Selezione misura e colore (fisso+porta)

Estensibilità	Fisso	Porta	Apert.	● CROMO	● NERO	● BIANCO
67-70	20	50	47	GL2050C	GL2050CN	GL2050CBL
72-74	25	50	47	GL2550C	GL2550CN	GL2550CBL
77-80	30	50	47	GL3050C	GL3050CN	GL3050CBL
82-85	20	65	62	GL2065C	GL2065CN	GL2065CBL
87-90	25	65	62	GL2565C	GL2565CN	GL2565CBL
87-90	20	70	67	GL2070C	GL2070CN	GL2070CBL
87-90	40	50	47	GL4050C	GL4050CN	GL4050CBL
92-95	25	70	67	GL2570C	GL2570CN	GL2570CBL
92-95	30	65	62	GL3065C	GL3065CN	GL3065CBL
97-100	30	70	67	GL3070C	GL3070CN	GL3070CBL
97-100	50	50	47	GL5050C	GL5050CN	GL5050CBL
97-100	20	80	77	GL2080C	GL2080CN	GL2080CBL
102-105	25	80	77	GL2580C	GL2580CN	GL2580CBL
102-105	40	65	62	GL4065C	GL4065CN	GL4065CBL
107-110	30	80	77	GL3080C	GL3080CN	GL3080CBL
107-110	40	70	67	GL4070C	GL4070CN	GL4070CBL
107-110	60	50	47	GL6050C	GL6050CN	GL6050CBL
112-115	50	65	62	GL5065C	GL5065CN	GL5065CBL
117-120	40	80	77	GL4080C	GL4080CN	GL4080CBL
117-120	50	70	67	GL5070C	GL5070CN	GL5070CBL
122-125	60	65	62	GL6065C	GL6065CN	GL6065CBL
127-130	50	80	77	GL5080C	GL5080CN	GL5080CBL
127-130	60	70	67	GL6070C	GL6070CN	GL6070CBL
137-140	60	80	77	GL6080C	GL6080CN	GL6080CBL

*Permette abbinamento con laterale fisso Glass nel lato della porta. L'estensibilità del frontale si ridurrà di 0,5 cm. Espandibile 3 cm. Vedi pag. 215

PASSO 2 - Selezionare il supporto

Descrizione	● CROMO	● NERO	● BIANCO
Braccetto regolabile 60 cm	1715	1715N	1715B
Barra fino a 140 cm con un supporto	1716	9026	1716BL



Descrizione	● CROMO	● NERO	● BIANCO
Profilo espansione +2 cm lato fisso	0218	9016	0218BL
Profilo espansione +4 cm lato fisso	0029		
Magnete espansione +1,2 cm (vedi pag. 295)	1221		

GLASS COMBI C fisso + porta a battente con chiusura magnetica a parete



Pannelli fissi e porte a misura vedi pag. 289



PASSO 1 - Selezione misura e colore (fisso+porta)

Estensibilità	Fisso	Porta	Apert.	ORO	RAME	NICHEL	TITANIO
67-70	20	50	47	GL2050COR	GL2050CCB	GL2050CNK	GL2050CT
72-74	25	50	47	GL2550COR	GL2550CCB	GL2550CNK	GL2550CT
77-80	30	50	47	GL3050COR	GL3050CCB	GL3050CNK	GL3050CT
82-85	20	65	62	GL2065COR	GL2065CCB	GL2065CNK	GL2065CT
87-90	25	65	62	GL2565COR	GL2565CCB	GL2565CNK	GL2565CT
87-90	20	70	67	GL2070COR	GL2070CCB	GL2070CNK	GL2070CT
87-90	40	50	47	GL4050COR	GL4050CCB	GL4050CNK	GL4050CT
92-95	25	70	67	GL2570COR	GL2570CCB	GL2570CNK	GL2570CT
92-95	30	65	62	GL3065COR	GL3065CCB	GL3065CNK	GL3065CT
97-100	30	70	67	GL3070COR	GL3070CCB	GL3070CNK	GL3070CT
97-100	50	50	47	GL5050COR	GL5050CCB	GL5050CNK	GL5050CT
97-100	20	80	77	GL2080COR	GL2080CCB	GL2080CNK	GL2080CT
102-105	25	80	77	GL2580COR	GL2580CCB	GL2580CNK	GL2580CT
102-105	40	65	62	GL4065COR	GL4065CCB	GL4065CNK	GL4065CT
107-110	30	80	77	GL3080COR	GL3080CCB	GL3080CNK	GL3080CT
107-110	40	70	67	GL4070COR	GL4070CCB	GL4070CNK	GL4070CT
107-110	60	50	47	GL6050COR	GL6050CCB	GL6050CNK	GL6050CT
112-115	50	65	62	GL5065COR	GL5065CCB	GL5065CNK	GL5065CT
117-120	40	80	77	GL4080COR	GL4080CCB	GL4080CNK	GL4080CT
117-120	50	70	67	GL5070COR	GL5070CCB	GL5070CNK	GL5070CT
122-125	60	65	62	GL6065COR	GL6065CCB	GL6065CNK	GL6065CT
127-130	50	80	77	GL5080COR	GL5080CCB	GL5080CNK	GL5080CT
127-130	60	70	67	GL6070COR	GL6070CCB	GL6070CNK	GL6070CT
137-140	60	80	77	GL6080COR	GL6080CCB	GL6080CNK	GL6080CT

*Permette abbinamento con laterale fisso Glass nel lato della porta. L'estensibilità del frontale si ridurrà di 0,5 cm. Espandibile 3 cm. Vedi pag. 215

PASSO 2 - Selezionare il supporto

Descrizione	ORO	RAME	NICHEL	TITANIO
Braccetto regolabile 60 cm	1715OR	1715CB	1715NK	1715T
Barra fino a 140 cm con un supporto	1716OR	1716CB	1716NK	1716T



Descrizione	ORO	RAME	NICHEL	TITANIO
Profilo espansione +2 cm lato fisso	0218OR	0218CB	0218NK	0218T
Magnete espansione +1,2 cm	1221			

GLASS COMBI C + Laterale fisso

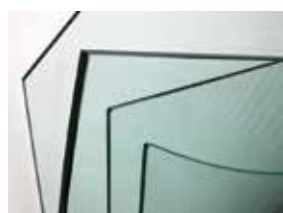
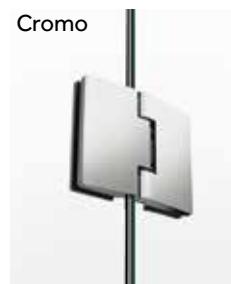

Lati fissi su misura GLASS/OPEN 6 mm (maggiori informazioni a pagina 291)

Descrizione	CROMO	NERO	BIANCO
Larghezza < 40 cm	1345	1345N	1345B
Larghezza > 40 e < 80 cm	1316	1316N	1316B
Larghezza > 80 e < 120 cm	1317	1317N	1317B

*Non include il braccetto, tempo di consegna 3 settimane

PASSO 1 - Selezione misura e colore (fisso+porta)

Estensibilità	Fisso	Porta	Apert.	CROMO	NERO	BIANCO
66,5-69,5	20	50	47	GL2050C	GL2050CN	GL2050CBL
71,5-74,5	25	50	47	GL2550C	GL2550CN	GL2550CBL
76,5-79,5	30	50	47	GL3050C	GL3050CN	GL3050CBL
81,5-84,5	20	65	62	GL2065C	GL2065CN	GL2065CBL
86,5-89,5	25	65	62	GL2565C	GL2565CN	GL2565CBL
86,5-89,5	20	70	67	GL2070C	GL2070CN	GL2070CBL
86,5-89,5	40	50	47	GL4050C	GL4050CN	GL4050CBL
91,5-94,5	25	70	67	GL2570C	GL2570CN	GL2570CBL
91,5-94,5	30	65	62	GL3065C	GL3065CN	GL3065CBL
96,5-99,5	30	70	67	GL3070C	GL3070CN	GL3070CBL
96,5-99,5	50	50	47	GL5050C	GL5050CN	GL5050CBL
96,5-99,5	20	80	77	GL2080C	GL2080CN	GL2080CBL
101,5-104,5	25	80	77	GL2580C	GL2580CN	GL2580CBL
101,5-104,5	40	65	62	GL4065C	GL4065CN	GL4065CBL
106,5-109,5	30	80	77	GL3080C	GL3080CN	GL3080CBL
106,5-109,5	40	70	67	GL4070C	GL4070CN	GL4070CBL
106,5-109,5	60	50	47	GL6050C	GL6050CN	GL6050CBL
111,5-114,5	50	65	62	GL5065C	GL5065CN	GL5065CBL
116,5-119,5	40	80	77	GL4080C	GL4080CN	GL4080CBL
116,5-119,5	50	70	67	GL5070C	GL5070CN	GL5070CBL
121,5-124,5	60	65	62	GL6065C	GL6065CN	GL6065CBL
126,5-129,5	50	80	77	GL5080C	GL5080CN	GL5080CBL
126,5-129,5	60	70	67	GL6070C	GL6070CN	GL6070CBL
136,5-139,5	60	80	77	GL6080C	GL6080CN	GL6080CBL

PASSO 2 - Selezionare il lato fisso

Descrizione	Estensibilità	CROMO	NERO	BIANCO
Laterale fisso da 70 cm	66-69	1720CR	1720N	1720BL
Laterale fisso da 80 cm	76-79	1721CR	1721N	1721BL
Laterale fisso da 90 cm	86-89	1722CR	1722N	1722BL

PASSO 3 - Selezionare il supporto

Descrizione	CROMO	NERO	BIANCO
Braccetto regolabile 60 cm	1715+1715	1715N+1715N	1715B+1715B
Barra fino a 140 cm con un supporto	1716+1718	9026+9028	1716BL+1718BL



Descrizione	CROMO	NERO	BIANCO
Profilo espansione +2 cm lato fisso	0218	9016	0218BL
Profilo espansione +4 cm lato fisso	0029		
Magnete espansione +1,2 cm (vedi pag. 295)	1221		

GLASS COMBI C + Laterale fisso



Lati fissi su misura GLASS/OPEN 6 mm (maggiori informazioni a pagina 291)

Descrizione	ORO	RAME	NICHEL	TITANIO
Larghezza < 40 cm	1345OR	1345CB	1345NK	1345T
Larghezza >40 e <80 cm	1316OR	1316CB	1316NK	1316T
Larghezza >80 e <120 cm	1317OR	1317CB	1317NK	1317T

*Non include il braccetto, tempo di consegna 3 settimane

PASSO 1 - Selezione misura e colore (fisso+porta)

Estensibilità	Fisso	Porta	Apert.	ORO	RAME	NICHEL	TITANIO
66,5-69,5	20	50	47	GL2050COR	GL2050CCB	GL2050CNK	GL2050CT
71,5-74,5	25	50	47	GL2550COR	GL2550CCB	GL2550CNK	GL2550CT
76,5-79,5	30	50	47	GL3050COR	GL3050CCB	GL3050CNK	GL3050CT
81,5-84,5	20	65	62	GL2065COR	GL2065CCB	GL2065CNK	GL2065CT
86,5-89,5	25	65	62	GL2565COR	GL2565CCB	GL2565CNK	GL2565CT
86,5-89,5	20	70	67	GL2070COR	GL2070CCB	GL2070CNK	GL2070CT
86,5-89,5	40	50	47	GL4050COR	GL4050CCB	GL4050CNK	GL4050CT
91,5-94,5	25	70	67	GL2570COR	GL2570CCB	GL2570CNK	GL2570CT
91,5-94,5	30	65	62	GL3065COR	GL3065CCB	GL3065CNK	GL3065CT
96,5-99,5	30	70	67	GL3070COR	GL3070CCB	GL3070CNK	GL3070CT
96,5-99,5	50	50	47	GL5050COR	GL5050CCB	GL5050CNK	GL5050CT
96,5-99,5	20	80	77	GL2080COR	GL2080CCB	GL2080CNK	GL2080CT
101,5-104,5	25	80	77	GL2580COR	GL2580CCB	GL2580CNK	GL2580CT
101,5-104,5	40	65	62	GL4065COR	GL4065CCB	GL4065CNK	GL4065CT
106,5-109,5	30	80	77	GL3080COR	GL3080CCB	GL3080CNK	GL3080CT
106,5-109,5	40	70	67	GL4070COR	GL4070CCB	GL4070CNK	GL4070CT
106,5-109,5	60	50	47	GL6050COR	GL6050CCB	GL6050CNK	GL6050CT
111,5-114,5	50	65	62	GL5065COR	GL5065CCB	GL5065CNK	GL5065CT
116,5-119,5	40	80	77	GL4080COR	GL4080CCB	GL4080CNK	GL4080CT
116,5-119,5	50	70	67	GL5070COR	GL5070CCB	GL5070CNK	GL5070CT
121,5-124,5	60	65	62	GL6065COR	GL6065CCB	GL6065CNK	GL6065CT
126,5-129,5	50	80	77	GL5080COR	GL5080CCB	GL5080CNK	GL5080CT
126,5-129,5	60	70	67	GL6070COR	GL6070CCB	GL6070CNK	GL6070CT
136,5-139,5	60	80	77	GL6080COR	GL6080CCB	GL6080CNK	GL6080CT

PASSO 2 - Selezionare il lato fisso

Descrizione	Estensibilità	ORO	RAME	NICHEL	TITANIO
Laterale fisso da 70 cm	66-69	1720OR	1720CB	1720NK	1720T
Laterale fisso da 80 cm	76-79	1721OR	1721CB	1721NK	1721T
Laterale fisso da 90 cm	86-89	1722OR	1722CB	1722NK	1722T

PASSO 3 - Selezionare il supporto

Descrizione	ORO	RAME	NICHEL	TITANIO
Braccetti sostegno regolabile 60 cm	1715OR+1715OR	1715CB+1715CB	1715NK+1715NK	1715T+1715T
Barra fino a 140 cm con un supporto	1716OR+1718OR	1716CB+1718CB	1716NK+1718NK	1716T+1718T



Descrizione	ORO	RAME	NICHEL	TITANIO
Profilo espansione +2 cm lato fisso	0218OR	0218CB	0218NK	0218T
Magnete espansione +1,2 cm (vedi pag. 295)	1221			

GLASS COMBI D Fisso + porta a battente con profilo a chiusura magnetica



Cromo



Nero



Bianco



Chiusura a profilo magnetica



Pannelli fissi e porte a misura vedi pag. 289

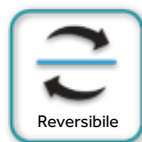

PASSO 1 - Selezione misura e colore (fisso+porta)

Estensibilità	Fisso	Porta	Apert.	CROMO	NERO	BIANCO
69,5-75	20	50	43	GL2050D	GL2050DN	GL2050DBL
74,5-80	25	50	43	GL2550D	GL2550DN	GL2550DBL
79,5-85	30	50	43	GL3050D	GL3050DN	GL3050DBL
84,5-90	20	65	58	GL2065D	GL2065DN	GL2065DBL
89,5-95	25	65	58	GL2565D	GL2565DN	GL2565DBL
89,5-95	20	70	63	GL2070D	GL2070DN	GL2070DBL
89,5-95	40	50	43	GL4050D	GL4050DN	GL4050DBL
94,5-100	25	70	63	GL2570D	GL2570DN	GL2570DBL
94,5-100	30	65	53	GL3065D	GL3065DN	GL3065DBL
99,5-105	30	70	63	GL3070D	GL3070DN	GL3070DBL
99,5-105	50	50	43	GL5050D	GL5050DN	GL5050DBL
99,5-105	20	80	73	GL2080D	GL2080DN	GL2080DBL
104,5-110	25	80	73	GL2580D	GL2580DN	GL2580DBL
104,5-110	40	65	58	GL4065D	GL4065DN	GL4065DBL
109,5-115	30	80	73	GL3080D	GL3080DN	GL3080DBL
109,5-115	40	70	63	GL4070D	GL4070DN	GL4070DBL
109,5-115	60	50	43	GL6050D	GL6050DN	GL6050DBL
114,5-120	50	65	58	GL5065D	GL5065DN	GL5065DBL
119,5-125	40	80	73	GL4080D	GL4080DN	GL4080DBL
119,5-125	50	70	63	GL5070D	GL5070DN	GL5070DBL
124,5-130	60	65	58	GL6065D	GL6065DN	GL6065DBL
129,5-135	50	80	73	GL5080D	GL5080DN	GL5080DBL
129,5-135	60	70	63	GL6070D	GL6070DN	GL6070DBL
139,5-145	60	80	73	GL6080D	GL6080DN	GL6080DBL

*Permette uso profilo di compensazione in entrambi i lati nelle finiture cromo e nero.

*Permette combinazione con laterale fisso STD nelle finiture cromo e nero, estensione minima +0,7 / espansione 3 cm (pag. 198)

PASSO 2 - Selezionare il supporto

Descrizione	CROMO	NERO	BIANCO
Braccetto regolabile 60 cm	1715	1715N	1715B
Barra fino a 140 cm con un supporto	1716	9026	1716BL



Descrizione	CROMO	NERO	BIANCO
Profilo espansione +2 cm lato fisso	0218	9016	0218BL
Profilo espansione +4 cm lato fisso	0029		
Magnete espansione +1,2 cm (vedi pag. 295)	1221		

GLASS COMBI D Fisso + porta a battente con profilo a chiusura magnetica

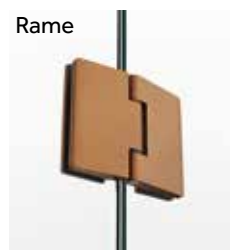

Pannelli fissi e porte a misura vedi pag. 289

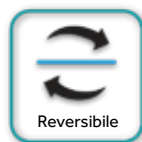

PASSO 1 - Selezione misura e colore (fisso+porta)

Estensibilità	Fisso	Porta	Apert.	ORO	RAME	NICHEL	TITANIO
69,5-75	20	50	43	GL2050DOR	GL2050DCB	GL2050DNK	GL2050DT
74,5-80	25	50	43	GL2550DOR	GL2550DCB	GL2550DNK	GL2550DT
79,5-85	30	50	43	GL3050DOR	GL3050DCB	GL3050DNK	GL3050DT
84,5-90	20	65	58	GL2065DOR	GL2065DCB	GL2065DNK	GL2065DT
89,5-95	25	65	58	GL2565DOR	GL2565DCB	GL2565DNK	GL2565DT
89,5-95	20	70	63	GL2070DOR	GL2070DCB	GL2070DNK	GL2070DT
89,5-95	40	50	43	GL4050DOR	GL4050DCB	GL4050DNK	GL4050DT
94,5-100	25	70	63	GL2570DOR	GL2570DCB	GL2570DNK	GL2570DT
94,5-100	30	65	53	GL3065DOR	GL3065DCB	GL3065DNK	GL3065DT
99,5-105	30	70	63	GL3070DOR	GL3070DCB	GL3070DNK	GL3070DT
99,5-105	50	50	43	GL5050DOR	GL5050DCB	GL5050DNK	GL5050DT
99,5-105	20	80	73	GL2080DOR	GL2080DCB	GL2080DNK	GL2080DT
104,5-110	25	80	73	GL2580DOR	GL2580DCB	GL2580DNK	GL2580DT
104,5-110	40	65	58	GL4065DOR	GL4065DCB	GL4065DNK	GL4065DT
109,5-115	30	80	73	GL3080DOR	GL3080DCB	GL3080DNK	GL3080DT
109,5-115	40	70	63	GL4070DOR	GL4070DCB	GL4070DNK	GL4070DT
109,5-115	60	50	43	GL6050DOR	GL6050DCB	GL6050DNK	GL6050DT
114,5-120	50	65	58	GL5065DOR	GL5065DCB	GL5065DNK	GL5065DT
119,5-125	40	80	73	GL4080DOR	GL4080DCB	GL4080DNK	GL4080DT
119,5-125	50	70	63	GL5070DOR	GL5070DCB	GL5070DNK	GL5070DT
124,5-130	60	65	58	GL6065DOR	GL6065DCB	GL6065DNK	GL6065DT
129,5-135	50	80	73	GL5080DOR	GL5080DCB	GL5080DNK	GL5080DT
129,5-135	60	70	63	GL6070DOR	GL6070DCB	GL6070DNK	GL6070DT
139,5-145	60	80	73	GL6080DOR	GL6080DCB	GL6080DNK	GL6080DT

PASSO 2 - Selezionare il supporto

Descrizione	ORO	RAME	NICHEL	TITANIO
Braccetto regolabile 60 cm	1715OR	1715CB	1715NK	1715T
Barra fino a 140 cm con un supporto	1716OR	1716CB	1716NK	1716T



Descrizione	ORO	RAME	NICHEL	TITANIO
Profilo espansione +2 cm lato fisso	0218OR	0218CB	0218NK	0218T
Magnete espansione +1,2 cm (vedi pag. 295)	1221			

GLASS COMBI G Fisso + 2 porte a battente + fisso



Cromo



Nero



Bianco



Chiusura magnetica



Pannelli fissi e porte a misura vedi pag. 289

PASSO 1 - Selezione misura e colore (fisso+pta+pta+fisso)

Estensibilità	Cm F+P+P+F	Apert.	CROMO	NERO	BIANCO
129,5-135,5	20+50+50+20	90	GL20505020G	GL20505020GN	GL20505020GBL
129,5-135,5	25+45+45+25	80	GL25454525G	GL25454525GN	GL25454525GBL
129,5-135,5	30+40+40+30	75	GL30404030G	GL30404030GN	GL30404030GBL
139,5-145,5	25+50+50+25	90	GL25505025G	GL25505025GN	GL25505025GBL
139,5-145,5	30+45+45+30	80	GL30454530G	GL30454530GN	GL30454530GBL
139,5-145,5	40+35+35+40	65	GL40353540G	GL40353540GN	GL40353540GBL
149,5-155,5	30+50+50+30	90	GL30505030G	GL30505030GN	GL30505030GBL
149,5-155,5	40+40+40+40	70	GL40404040G	GL40404040GN	GL40404040GBL
159,5-165,5	20+65+65+20	120	GL20656520G	GL20656520GN	GL20656520GBL
159,5-165,5	40+45+45+40	80	GL40454540G	GL40454540GN	GL40454540GBL
159,5-165,5	50+35+35+50	60	GL50353550G	GL50353550GN	GL50353550GBL
169,5-175,5	20+70+70+20	130	GL20707020G	GL20707020GN	GL20707020GBL
169,5-175,5	25+65+65+25	120	GL25656525G	GL25656525GN	GL25656525GBL
169,5-175,5	40+50+50+40	90	GL40505040G	GL40505040GN	GL40505040GBL
169,5-175,5	50+40+40+50	70	GL50404050G	GL50404050GN	GL50404050GBL
179,5-185,5	25+70+70+25	130	GL25707025G	GL25707025GN	GL25707025GBL
179,5-185,5	30+65+65+30	120	GL30656530G	GL30656530GN	GL30656530GBL
179,5-185,5	50+45+45+50	80	GL50454550G	GL50454550GN	GL50454550GBL
179,5-185,5	60+35+35+60	60	GL60353560G	GL60353560GN	GL60353560GBL
189,5-195,5	20+80+80+20	150	GL20808020G	GL20808020GN	GL20808020GBL
189,5-195,5	30+70+70+30	130	GL30707030G	GL30707030GN	GL30707030GBL
189,5-195,5	50+50+50+50	90	GL50505050G	GL50505050GN	GL50505050GBL
189,5-195,5	60+40+40+60	70	GL60404060G	GL60404060GN	GL60404060GBL
199,5-205,5	25+80+80+25	150	GL25808025G	GL25808025GN	GL25808025GBL
199,5-205,5	40+65+65+40	120	GL40656540G	GL40656540GN	GL40656540GBL
199,5-205,5	60+45+45+60	80	GL60454560G	GL60454560GN	GL60454560GBL
209,5-215,5	30+80+80+30	150	GL30808030G	GL30808030GN	GL30808030GBL
209,5-215,5	40+70+70+40	130	GL40707040G	GL40707040GN	GL40707040GBL
209,5-215,5	60+50+50+60	90	GL60505060G	GL60505060GN	GL60505060GBL
219,5-225,5	50+65+65+50	120	GL50656550G	GL50656550GN	GL50656550GBL
229,5-235,5	40+80+80+40	150	GL40808040G	GL40808040GN	GL40808040GBL
229,5-235,5	50+70+70+50	130	GL50707050G	GL50707050GN	GL50707050GBL
239,5-245,5	60+65+65+60	120	GL60656560G	GL60656560GN	GL60656560GBL
249,5-255,5	50+80+80+50	150	GL50808050G	GL50808050GN	GL50808050GBL
249,5-255,5	60+70+70+60	130	GL60707060G	GL60707060GN	GL60707060GBL
269,5-275,5	60+80+80+60	150	GL60808060G	GL60808060GN	GL60808060GBL

*Permette uso profilo di compensazione in entrambi i lati nelle finiture cromo e nero.

*Permette combinazione con laterale fisso STD nelle finiture cromo e nero, estensione minima +0,7 / espandibile 3 cm (vedi pag. 198)

PASSO 2 - Selezionare il supporto

Descrizione	CROMO	NERO	BIANCO
Braccetto regolabile 60 cm	1715+1715	1715N+1715N	1715B+1715B
Barra 200 cm con 2 supporti (solo fino a 2 metri)	1717	9027	1717BL

Descrizione	CROMO	NERO	BIANCO
Profilo espansione +2 cm lato fisso	0218	9016	0218BL
Profilo espansione +4 cm lato fisso	0029		
Magnete espansione +1,2 cm (vedi pag. 295)		1221	

GLASS COMBI G Fisso + 2 porte a battente + fisso



Pannelli fissi e porte a misura vedi pag. 289

PASSO 1 - Selezione misura e colore (fisso+pta+pta+fisso)

Estensibilità	Cm F+P+P+F	Apert.	ORO	RAME	NICHEL	TITANIO
129,5-135,5	20+50+50+20	90	GL20505020GOR	GL20505020GCB	GL20505020GNK	GL20505020GT
129,5-135,5	25+45+45+25	80	GL25454525GOR	GL25454525GCB	GL25454525GNK	GL25454525GT
129,5-135,5	30+40+40+30	75	GL30404030GOR	GL30404030GCB	GL30404030GNK	GL30404030GT
139,5-145,5	25+50+50+25	90	GL25505025GOR	GL25505025GCB	GL25505025GNK	GL25505025GT
139,5-145,5	30+45+45+30	80	GL30454530GOR	GL30454530GCB	GL30454530GNK	GL30454530GT
139,5-145,5	40+35+35+40	65	GL40353540GOR	GL40353540GCB	GL40353540GNK	GL40353540GT
149,5-155,5	30+50+50+30	90	GL30505030GOR	GL30505030GCB	GL30505030GNK	GL30505030GT
149,5-155,5	40+40+40+40	70	GL40404040GOR	GL40404040GCB	GL40404040GNK	GL40404040GT
159,5-165,5	20+65+65+20	120	GL20656520GOR	GL20656520GCB	GL20656520GNK	GL20656520GT
159,5-165,5	40+45+45+40	80	GL40454540GOR	GL40454540GCB	GL40454540GNK	GL40454540GT
159,5-165,5	50+35+35+50	60	GL50353550GOR	GL50353550GCB	GL50353550GNK	GL50353550GT
169,5-175,5	20+70+70+20	130	GL20707020GOR	GL20707020GCB	GL20707020GNK	GL20707020GT
169,5-175,5	25+65+65+25	120	GL25656525GOR	GL25656525GCB	GL25656525GNK	GL25656525GT
169,5-175,5	40+50+50+40	90	GL40505040GOR	GL40505040GCB	GL40505040GNK	GL40505040GT
169,5-175,5	50+40+40+50	70	GL50404050GOR	GL50404050GCB	GL50404050GNK	GL50404050GT
179,5-185,5	25+70+70+25	130	GL25707025GOR	GL25707025GCB	GL25707025GNK	GL25707025GT
179,5-185,5	30+65+65+30	120	GL30656530GOR	GL30656530GCB	GL30656530GNK	GL30656530GT
179,5-185,5	50+45+45+50	80	GL50454550GOR	GL50454550GCB	GL50454550GNK	GL50454550GT
179,5-185,5	60+35+35+60	60	GL60353560GOR	GL60353560GCB	GL60353560GNK	GL60353560GT
189,5-195,5	20+80+80+20	150	GL20808020GOR	GL20808020GCB	GL20808020GNK	GL20808020GT
189,5-195,5	30+70+70+30	130	GL30707030GOR	GL30707030GCB	GL30707030GNK	GL30707030GT
189,5-195,5	50+50+50+50	90	GL50505050GOR	GL50505050GCB	GL50505050GNK	GL50505050GT
189,5-195,5	60+40+40+60	70	GL60404060GOR	GL60404060GCB	GL60404060GNK	GL60404060GT
199,5-205,5	25+80+80+25	150	GL25808025GOR	GL25808025GCB	GL25808025GNK	GL25808025GT
199,5-205,5	40+65+65+40	120	GL40656540GOR	GL40656540GCB	GL40656540GNK	GL40656540GT
199,5-205,5	60+45+45+60	80	GL60454560GOR	GL60454560GCB	GL60454560GNK	GL60454560GT
209,5-215,5	30+80+80+30	150	GL30808030GOR	GL30808030GCB	GL30808030GNK	GL30808030GT
209,5-215,5	40+70+70+40	130	GL40707040GOR	GL40707040GCB	GL40707040GNK	GL40707040GT
209,5-215,5	60+50+50+60	90	GL60505060GOR	GL60505060GCB	GL60505060GNK	GL60505060GT
219,5-225,5	50+65+65+50	120	GL50656550GOR	GL50656550GCB	GL50656550GNK	GL50656550GT
229,5-235,5	40+80+80+40	150	GL40808040GOR	GL40808040GCB	GL40808040GNK	GL40808040GT
229,5-235,5	50+70+70+50	130	GL50707050GOR	GL50707050GCB	GL50707050GNK	GL50707050GT
239,5-245,5	60+65+65+60	120	GL60656560GOR	GL60656560GCB	GL60656560GNK	GL60656560GT
249,5-255,5	50+80+80+50	150	GL50808050GOR	GL50808050GCB	GL50808050GNK	GL50808050GT
249,5-255,5	60+70+70+60	130	GL60707060GOR	GL60707060GCB	GL60707060GNK	GL60707060GT
269,5-275,5	60+80+80+60	150	GL60808060GOR	GL60808060GCB	GL60808060GNK	GL60808060GT

CERNIERE

PASSO 2 - Selezionare il supporto

Descrizione	ORO	RAME	NICHEL	TITANIO
Braccetto regolabile 60 cm	1715OR+1715OR	1715CB+1715CB	1715NK+1715NK	1715T+1715T
Barra 200 cm con 2 supporti	1717OR	1717CB	1717NK	1717T

Descrizione	ORO	RAME	NICHEL	TITANIO
Profilo espansione +2 cm lato fisso	0218OR	0218CB	0218NK	0218T
Magnete espansione +1,2 cm (vedi pag. 295)	1221			

GLASS COMBI H Fisso + 2 porte a battente + fisso

GL3070C+ GL2050C+1715+1715



Cromo



Nero



Bianco



Chiusura magnetica



Pannelli fissi e porte a misura vedi pag. 289

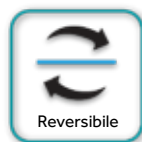

PASSO 1 - Selezione di 2 lati del box doccia

Estensibilità	Fisso	Porta	● CROMO	● NERO	● BIANCO
67-70	20	50	GL2050C	GL2050CN	GL2050CBL
72-75	25	50	GL2550C	GL2550CN	GL2550CBL
77-80	30	50	GL3050C	GL3050CN	GL3050CBL
82-85	20	65	GL2065C	GL2065CN	GL2065CBL
87-90	25	65	GL2565C	GL2565CN	GL2565CBL
87-90	20	70	GL2070C	GL2070CN	GL2070CBL
87-90	40	50	GL4050C	GL4050CN	GL4050CBL
92-95	25	70	GL2570C	GL2570CN	GL2570CBL
92-95	30	65	GL3065C	GL3065CN	GL3065CBL
97-100	30	70	GL3070C	GL3070CN	GL3070CBL
97-100	50	50	GL5050C	GL5050CN	GL5050CBL
97-100	20	80	GL2080C	GL2080CN	GL2080CBL
102-105	25	80	GL2580C	GL2580CN	GL2580CBL
102-105	40	65	GL4065C	GL4065CN	GL4065CBL
107-110	30	80	GL3080C	GL3080CN	GL3080CBL
107-110	40	70	GL4070C	GL4070CN	GL4070CBL
107-110	60	50	GL6050C	GL6050CN	GL6050CBL
112-115	50	65	GL5065C	GL5065CN	GL5065CBL
117-120	40	80	GL4080C	GL4080CN	GL4080CBL
117-120	50	70	GL5070C	GL5070CN	GL5070CBL
122-125	60	65	GL6065C	GL6065CN	GL6065CBL
127-130	50	80	GL5080C	GL5080CN	GL5080CBL
127-130	60	70	GL6070C	GL6070CN	GL6070CBL
137-140	60	80	GL6080C	GL6080CN	GL6080CBL

*Esempi: 120 (40+80) X 80 (30+50) + braccetti nero = GL4080CN + GL3050CN + 1715N + 1715N

PASSO 2 - Selezionare il supporto

Descrizione	● CROMO	● NERO	● BIANCO
Braccetti sostegno regolabile 60 cm	1715+1715	1715N+1715N	1715B+1715B
Barras fino a 140 cm con un supporto	1716+1716+1730		



Descrizione	● CROMO	● NERO	● BIANCO
Profilo espansione +2 cm lato fisso	0218	9016	0218BL
Profilo espansione +4 cm lato fisso	0029		
Magnete espansione +1,2 cm (vedi pag. 295)	1221		

GLASS COMBI H angolare 2 porte a battente + 2 fissi



Oro



Rame



Nichel



Titanio



Chiusura magnetica



Pannelli fissi e porte a misura vedi pag. 289

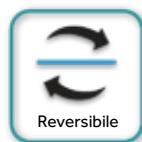
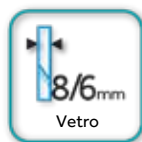

PASSO 1 - Selezione di 2 lati del box doccia

Estensibilità	Fisso	Porta	ORO	RAME	NICHEL	TITANIO
67-70	20	50	GL2050COR	GL2050CCB	GL2050CNK	GL2050CT
72-75	25	50	GL2550COR	GL2550CCB	GL2550CNK	GL2550CT
77-80	30	50	GL3050COR	GL3050CCB	GL3050CNK	GL3050CT
82-85	20	65	GL2065COR	GL2065CCB	GL2065CNK	GL2065CT
87-90	25	65	GL2565COR	GL2565CCB	GL2565CNK	GL2565CT
87-90	20	70	GL2070COR	GL2070CCB	GL2070CNK	GL2070CT
87-90	40	50	GL4050COR	GL4050CCB	GL4050CNK	GL4050CT
92-95	25	70	GL2570COR	GL2570CCB	GL2570CNK	GL2570CT
92-95	30	65	GL3065COR	GL3065CCB	GL3065CNK	GL3065CT
97-100	30	70	GL3070COR	GL3070CCB	GL3070CNK	GL3070CT
97-100	50	50	GL5050COR	GL5050CCB	GL5050CNK	GL5050CT
97-100	20	80	GL2080COR	GL2080CCB	GL2080CNK	GL2080CT
102-105	25	80	GL2580COR	GL2580CCB	GL2580CNK	GL2580CT
102-105	40	65	GL4065COR	GL4065CCB	GL4065CNK	GL4065CT
107-110	30	80	GL3080COR	GL3080CCB	GL3080CNK	GL3080CT
107-110	40	70	GL4070COR	GL4070CCB	GL4070CNK	GL4070CT
107-110	60	50	GL6050COR	GL6050CCB	GL6050CNK	GL6050CT
112-115	50	65	GL5065COR	GL5065CCB	GL5065CNK	GL5065CT
117-120	40	80	GL4080COR	GL4080CCB	GL4080CNK	GL4080CT
117-120	50	70	GL5070COR	GL5070CCB	GL5070CNK	GL5070CT
122-125	60	65	GL6065COR	GL6065CCB	GL6065CNK	GL6065CT
127-130	50	80	GL5080COR	GL5080CCB	GL5080CNK	GL5080CT
127-130	60	70	GL6070COR	GL6070CCB	GL6070CNK	GL6070CT
137-140	60	80	GL6080COR	GL6080CCB	GL6080CNK	GL6080CT

Esempi: 70 (20+50) x 70 (20+50) oro = GL2050OR + GL2050OR + 1715OR+1715OR

PASSO 2 - Selezionare il supporto

Descrizione	ORO	RAME	NICHEL	TITANIO
Braccetto regolabile 60 cm	1715OR+1715OR	1715CB+1715CB	1715NK+1715NK	1715T+1715T

Descrizione	ORO	RAME	NICHEL	TITANIO
Profilo espansione +2 cm lato fisso	0218OR	0218CB	0218NK	0218T
Magnete espansione +1,2 cm (vedi pag. 295)	1221			

GLASS COMBI I 2 porte a battente



Estensibilità	Porta	Porta	Apert.	● CROMO	● NERO	● BIANCO
83-87	40	40	70	GL4040I	GL4040IN	GL4040IBL
88-92	40	45	75	GL4045I	GL4045IN	GL4045IBL
93-97	45	45	80	GL4545I	GL4545IN	GL4545IBL
98-102	45	50	85	GL4550I	GL4550IN	GL4550IBL
103-107	50	50	90	GL5050I	GL5050IN	GL5050IBL
118-122	50	65	105	GL5065I	GL5065IN	GL5065IBL
133-137	65	65	120	GL6565I	GL6565IN	GL6565IBL
138-142	65	70	125	GL6570I	GL6570IN	GL6570IBL
143-147	70	70	130	GL7070I	GL7070IN	GL7070IBL
153-157	70	80	140	GL7080I	GL7080IN	GL7080IBL
163-167	80	80	150	GL8080I	GL8080IN	GL8080IBL

*Può essere installato anche con cerniera a muro; estensibilità si riduce di 3,1 cm per ogni lato in cui viene installato.

Descrizione	Art.
Magnete espansione +1,2 cm (vedi pag. 295)	1221

GLASS COMBI I 2 porte a battente



CERNIERE

Estensibilità	Porta	Porta	Apert.	ORO	RAME	NICHEL	TITANIO
83-87	40	40	70	GL4040IOR	GL4040ICB	GL4040INK	GL4040IT
88-92	40	45	75	GL4045IOR	GL4045ICB	GL4045INK	GL4045IT
93-97	45	45	80	GL4545IOR	GL4545ICB	GL4545INK	GL4545IT
98-102	45	50	85	GL4550IOR	GL4550ICB	GL4550INK	GL4550IT
103-107	50	50	90	GL5050IOR	GL5050ICB	GL5050INK	GL5050IT
118-122	50	65	105	GL5065IOR	GL5065ICB	GL5065INK	GL5065IT
133-137	65	65	120	GL6565IOR	GL6565ICB	GL6565INK	GL6565IT
138-142	65	70	125	GL6570IOR	GL6570ICB	GL6570INK	GL6570IT
143-147	70	70	130	GL7070IOR	GL7070ICB	GL7070INK	GL7070IT
153-157	70	80	140	GL7080IOR	GL7080ICB	GL7080INK	GL7080IT
163-167	80	80	150	GL8080IOR	GL8080ICB	GL8080INK	GL8080IT

*Può essere installato anche con cerniera a muro; estensibilità si riduce di 3,1 cm per ogni lato in cui viene installato.

Descrizione	Art.
Magnete espansione +1,2 cm (vedi pag. 295)	1221

GLASS COMBI K 2 porte a battente apertura angolare



Pannelli fissi e porte a misura vedi pag. 289

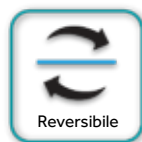

Estensibilità	Porta	Porta	CROMO	NERO	BIANCO
43,5-45,5/43,5-45,5	40	40	GL4040K	GL4040KN	GL4040KBL
48,5-50,5/43,5-45,5	45	40	GL4540K	GL4540KN	GL4540KBL
53,5-55,5/43,5-45,5	50	40	GL5040K	GL5040KN	GL5040KBL
68,5-70,5/43,5-45,5	65	40	GL6540K	GL6540KN	GL6540KBL
73,5-75,5/43,5-45,5	70	40	GL7040K	GL7040KN	GL7040KBL
83,5-85,5/43,5-45,5	80	40	GL8040K	GL8040KN	GL8040KBL
43,5-45,5/48,5-50,5	40	45	GL4045K	GL4045KN	GL4045KBL
48,5-50,5/48,5-50,5	45	45	GL4545K	GL4545KN	GL4545KBL
53,5-55,5/48,5-50,5	50	45	GL5045K	GL5045KN	GL5045KBL
68,5-70,5/48,5-50,5	65	45	GL6545K	GL6545KN	GL6545KBL
73,5-75,5/48,5-50,5	70	45	GL7045K	GL7045KN	GL7045KBL
83,5-85,5/48,5-50,5	80	45	GL8045K	GL8045KN	GL8045KBL
43,5-45,5/53,5-55,5	40	50	GL4050K	GL4050KN	GL4050KBL
48,5-50,5/53,5-55,5	45	50	GL4550K	GL4550KN	GL4550KBL
53,5-55,5/53,5-55,5	50	50	GL5050K	GL5050KN	GL5050KBL
68,5-70,5/53,5-55,5	65	50	GL6550K	GL6550KN	GL6550KBL
73,5-75,5/53,5-55,5	70	50	GL7050K	GL7050KN	GL7050KBL
83,5-85,5/53,5-55,5	80	50	GL8050K	GL8050KN	GL8050KBL
43,5-45,5/68,5-70,5	40	65	GL4065K	GL4065KN	GL4065KBL
48,5-50,5/68,5-70,5	45	65	GL4565K	GL4565KN	GL4565KBL
53,5-55,5/68,5-70,5	50	65	GL5065K	GL5065KN	GL5065KBL
68,5-70,5/68,5-70,5	65	65	GL6565K	GL6565KN	GL6565KBL
73,5-75,5/68,5-70,5	70	65	GL7065K	GL7065KN	GL7065KBL
83,5-85,5/68,5-70,5	80	65	GL8065K	GL8065KN	GL8065KBL
43,5-45,5/73,5-75,5	40	70	GL4070K	GL4070KN	GL4070KBL
48,5-50,5/73,5-75,5	45	70	GL4570K	GL4570KN	GL4570KBL
53,5-55,5/73,5-75,5	50	70	GL5070K	GL5070KN	GL5070KBL
68,5-70,5/73,5-75,5	65	70	GL6570K	GL6570KN	GL6570KBL
73,5-75,5/73,5-75,5	70	70	GL7070K	GL7070KN	GL7070KBL
83,5-85,5/73,5-75,5	80	70	GL8070K	GL8070KN	GL8070KBL
43,5-45,5/83,5-85,5	40	80	GL4080K	GL4080KN	GL4080KBL
48,5-50,5/83,5-85,5	45	80	GL4580K	GL4580KN	GL4580KBL
53,5-55,5/83,5-85,5	50	80	GL5080K	GL5080KN	GL5080KBL
68,5-70,5/83,5-85,5	65	80	GL6580K	GL6580KN	GL6580KBL
73,5-75,5/83,5-85,5	70	80	GL7080K	GL7080KN	GL7080KBL
83,5-85,5/83,5-85,5	80	80	GL8080K	GL8080KN	GL8080KBL

*Può essere installato anche con cerniera a muro, estensibilità si riduce di 3,1 cm da ogni lato in cui viene installato.

*Permette uso profilo di compensazione in entrambi i lati nelle finiture cromo e nero.

Descrizione	CROMO	NERO	BIANCO
Profilo espansione +2 cm lato fisso	0218	9016	0218BL
Profilo espansione +4 cm lato fisso	0029		
Magnete espansione +1,2 cm (vedi pag. 295)	1221		

GLASS COMBI K 2 porte a battente apertura angolare



Pannelli fissi e porte a misura vedi pag. 289

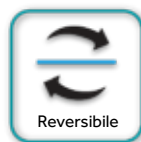

Estensibilità	Porta	Porta	ORO	RAME	NICHEL	TITANIO
43,5-45,5/43,5-45,5	40	40	GL4040KOR	GL4040KCB	GL4040KNK	GL4040KT
48,5-50,5/43,5-45,5	45	40	GL4540KOR	GL4540KCB	GL4540KNK	GL4540KT
53,5-55,5/43,5-45,5	50	40	GL5040KOR	GL5040KCB	GL5040KNK	GL5040KT
68,5-70,5/43,5-45,5	65	40	GL6540KOR	GL6540KCB	GL6540KNK	GL6540KT
73,5-75,5/43,5-45,5	70	40	GL7040KOR	GL7040KCB	GL7040KNK	GL7040KT
83,5-85,5/43,5-45,5	80	40	GL8040KOR	GL8040KCB	GL8040KNK	GL8040KT
43,5-45,5/48,5-50,5	40	45	GL4045KOR	GL4045KCB	GL4045KNK	GL4045KT
48,5-50,5/48,5-50,5	45	45	GL4545KOR	GL4545KCB	GL4545KNK	GL4545KT
53,5-55,5/48,5-50,5	50	45	GL5045KOR	GL5045KCB	GL5045KNK	GL5045KT
68,5-70,5/48,5-50,5	65	45	GL6545KOR	GL6545KCB	GL6545KNK	GL6545KT
73,5-75,5/48,5-50,5	70	45	GL7045KOR	GL7045KCB	GL7045KNK	GL7045KT
83,5-85,5/48,5-50,5	80	45	GL8045KOR	GL8045KCB	GL8045KNK	GL8045KT
43,5-45,5/53,5-55,5	40	50	GL4050KOR	GL4050KCB	GL4050KNK	GL4050KT
48,5-50,5/53,5-55,5	45	50	GL4550KOR	GL4550KCB	GL4550KNK	GL4550KT
53,5-55,5/53,5-55,5	50	50	GL5050KOR	GL5050KCB	GL5050KNK	GL5050KT
68,5-70,5/53,5-55,5	65	50	GL6550KOR	GL6550KCB	GL6550KNK	GL6550KT
73,5-75,5/53,5-55,5	70	50	GL7050KOR	GL7050KCB	GL7050KNK	GL7050KT
83,5-85,5/53,5-55,5	80	50	GL8050KOR	GL8050KCB	GL8050KNK	GL8050KT
43,5-45,5/68,5-70,5	40	65	GL4065KOR	GL4065KCB	GL4065KNK	GL4065KT
48,5-50,5/68,5-70,5	45	65	GL4565KOR	GL4565KCB	GL4565KNK	GL4565KT
53,5-55,5/68,5-70,5	50	65	GL5065KOR	GL5065KCB	GL5065KNK	GL5065KT
68,5-70,5/68,5-70,5	65	65	GL6565KOR	GL6565KCB	GL6565KNK	GL6565KT
73,5-75,5/68,5-70,5	70	65	GL7065KOR	GL7065KCB	GL7065KNK	GL7065KT
83,5-85,5/68,5-70,5	80	65	GL8065KOR	GL8065KCB	GL8065KNK	GL8065KT
43,5-45,5/73,5-75,5	40	70	GL4070KOR	GL4070KCB	GL4070KNK	GL4070KT
48,5-50,5/73,5-75,5	45	70	GL4570KOR	GL4570KCB	GL4570KNK	GL4570KT
53,5-55,5/73,5-75,5	50	70	GL5070KOR	GL5070KCB	GL5070KNK	GL5070KT
68,5-70,5/73,5-75,5	65	70	GL6570KOR	GL6570KCB	GL6570KNK	GL6570KT
73,5-75,5/73,5-75,5	70	70	GL7070KOR	GL7070KCB	GL7070KNK	GL7070KT
83,5-85,5/73,5-75,5	80	70	GL8070KOR	GL8070KCB	GL8070KNK	GL8070KT
43,5-45,5/83,5-85,5	40	80	GL4080KOR	GL4080KCB	GL4080KNK	GL4080KT
48,5-50,5/83,5-85,5	45	80	GL4580KOR	GL4580KCB	GL4580KNK	GL4580KT
53,5-55,5/83,5-85,5	50	80	GL5080KOR	GL5080KCB	GL5080KNK	GL5080KT
68,5-70,5/83,5-85,5	65	80	GL6580KOR	GL6580KCB	GL6580KNK	GL6580KT
73,5-75,5/83,5-85,5	70	80	GL7080KOR	GL7080KCB	GL7080KNK	GL7080KT
83,5-85,5/83,5-85,5	80	80	GL8080KOR	GL8080KCB	GL8080KNK	GL8080KT

*Può essere installato anche con cerniera a muro, estensibilità si riduce di 3,1 cm da ogni lato in cui viene installato.

*Permette uso profilo di compensazione in entrambi i lati.

Descrizione	ORO	RAME	NICHEL	TITANIO
Profilo espansione +2 cm lato fisso	0218OR	0218CB	0218NK	0218T
Magnete espansione +1,2 cm (vedi pag. 295)	1221			



GME
COLAB

CONFIGURATORE



Registro



Altre informazioni

Configurazione della cabina doccia

Scoprite il nostro configuratore di schermi disponibile sul nostro B2B, uno strumento intuitivo e visivo progettato per facilitare la selezione e la personalizzazione dei vostri schermi. Con questo configuratore potete scegliere con facilità e precisione le dimensioni, il modello, il colore e le finiture del vetro, assicurandovi che ogni dettaglio sia adattato alle vostre esigenze e preferenze.

Caratteristiche del configuratore:

- **Selezione visiva:** Scegliete le dimensioni, il modello, il colore e le finiture del vetro in modo semplice e visivo.
- **Evitare gli errori:** Riduce gli errori nella trasmissione degli ordini manuali grazie alla sua interfaccia intuitiva.
- **Accesso online:** Disponibile in qualsiasi momento e ovunque, in modo da poter effettuare le configurazioni quando ne avete bisogno.

Ottimizzate il processo di selezione e garantite l'accuratezza dei vostri ordini con il nostro configuratore di cabina doccia.



Disponibile per i modelli:

BASIC 1F+1P+1F



OPEN



GLASS



PROGRAMMA MODULARE GLASS







FISSI (vetro singolo)

FISSI	Estensibilità	Art.
Fisso 20	17-20	1700
Fisso 25	22-25	1701
Fisso 30	27-30	1702
Fisso 40	37-40	1703
Fisso 50	47-50	1704
Fisso 60	57-60	1705

PORTE (vetro singolo)

PORTE	Cm	Art.
Porta 30	30	1725
Porta 35	35	1727
Porta 40	40	1726
Porta 45	45	1728
Porta 50	50	1706
Porta 65	65	1707
Porta 70	70	1708
Porta 80	80	1709





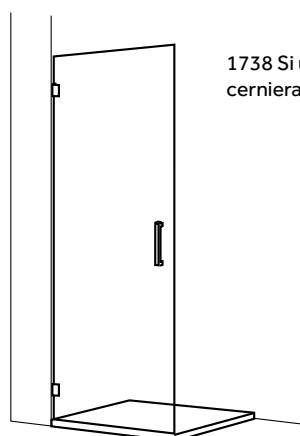

ACCESSORI PORTA GLASS CON CERNIERA A PARETE

FINITURA	Art.
 CROMO	1738
 NERO	1738N
 BIANCO	1738BL
 ORO	1738OR
 RAME	1738CB
 NICHEL	1738NK
 TITANIO	1738T



1738 Si utilizza sia per la cerniera a muro che per la cerniera a profilo.

ACCESSORI PORTA GLASS CON CERNIERA A FISSO

FINITURA	Art.
 CROMO	1737
 NERO	1737N
 BIANCO	1737BL
 ORO	1737OR
 RAME	1737CB
 NICHEL	1737NK
 TITANIO	1737T

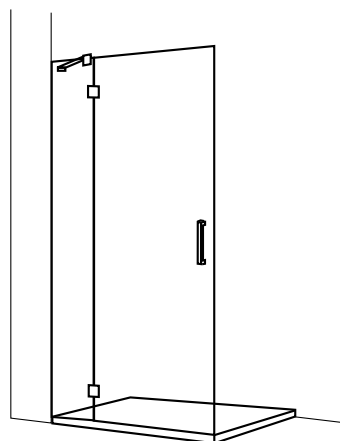

Lati fissi 6 mm

Descrizione	Art.
Cristallo laterale fisso 70	1760
Cristallo laterale fisso 80	1761
Cristallo laterale fisso 90	1762
Descrizione	Art.
Profilo della parete cromo	5429
Profilo della parete nero	5477
Profilo della parete bianco	5473
Profilo della parete oro	5474
Profilo della parete rame	5476
Profilo della parete nichel	5475
Profilo della parete titanio	5478

GME

GLASS PIEGHEVOLE pg.244
1 fisso + 1 porta pieghevole



SPAZIO pg.244
1 porta scorrevole



AKORD pg.250
2 porte pieghevoli

TANDEM pg.248
Pieghevole + fisso e scorrevole



PIEGHEVOLE

**H195**

Altezza

**6mm**

Vetro



Pieghevole



Magnetico

**1.5cm**

Combi 1

**2.5/1.5cm**

Combi 2



Reversibile

aluminio
AL
aluminiumclear
shield
glass

GLASS PIEGHEVOLE



COMBI 1 chiusura magnetica a parete

Cm	Estensibilità	Art.
60 (30+30)	57,5-59	1712+1725
70 (40+30)	67,5-69	1713+1725
75 (40+35)	72,5-74	1713+1727
80 (40+40)	77,5-79	1713+1726
80 (50+30)	77,5-79	1714+1725
85 (50+35)	82,5-84	1714+1727
90 (50+40)	87,5-89	1714+1726
95 (50+45)	92,5-94	1714+1728
100 (50+50)	97,5-99	1714+1706

Permette abbinamento con laterale fisso Glass nel lato della porta. L'estensibilità del frontale si ridurrà di 0,5 cm.

Descrizione	Art.
Profilo porta (riduce fino 1 cm l'estensione)	1215
Profilo espansione +2,5 cm	1222
Magnete di espansione +1,2 cm	1221



Opzione porte su misura (vedi pag. 289)

Descrizione	Art.
Porta < 80 cm	1338



COMBI 2 prof. a chiusura magnetica

Cm	Estensibilità	Art.
65 (30+30)	60-64	1712+1725+1212
75 (40+30)	70-74	1713+1725+1212
80 (40+35)	75-79	1713+1727+1212
85 (40+40)	80-84	1713+1726+1212
85 (50+30)	80-84	1714+1725+1212
90 (50+35)	85-89	1714+1727+1212
95 (50+40)	90-94	1714+1726+1212
100 (50+45)	95-99	1714+1728+1212
105 (50+50)	100-104	1714+1706+1212

Permette combinazione con laterale fisso STD nel lato porta, l'estensibilità minima del frontale aumenta di 0,7 cm

Descrizione	Art.
Profilo porta (riduce fino 1 cm l'estensione)	1215
Profilo espansione lato vetro +2,5 cm	1222
Magnete di espansione +1,2 cm	1221
Prof. esp. lato prof. a chiusura magnetica +3cm	0218
Prof. esp. lato prof. a chiusura magnetica +6cm	0029



GLASS PIEGHEVOLE NERA



COMBI 1 chiusura magnetica a parete

Cm	Estensibilità	Art.
60 (30+30)	57,5-59	1712N+1725
70 (40+30)	67,5-69	1713N+1725
75 (40+35)	72,5-74	1713N+1727
80 (40+40)	77,5-79	1713N+1726
80 (50+30)	77,5-79	1714N+1725
85 (50+35)	82,5-84	1714N+1727
90 (50+40)	87,5-89	1714N+1726
95 (50+45)	92,5-94	1714N+1728
100 (50+50)	97,5-99	1714N+1706

Permette abbinamento con laterale fisso Glass nel lato della porta. L'estensibilità del frontale si ridurrà di 0,5 cm.

Descrizione	Art.
Profilo porta (riduce fino 1 cm l'estensione)	9014
Profilo espansione +2,5 cm	9015
Magnete di espansione +1,2 cm	1221

COMBI 2 prof. a chiusura magnetica

Cm	Estensibilità	Art.
65 (30+30)	60-64	1712N+1725+9013
75 (40+30)	70-74	1713N+1725+9013
80 (40+35)	75-79	1713N+1727+9013
85 (40+40)	80-84	1713N+1726+9013
85 (50+30)	80-84	1714N+1725+9013
90 (50+35)	85-89	1714N+1727+9013
95 (50+40)	90-94	1714N+1726+9013
100 (50+45)	95-99	1714N+1728+9013
105 (50+50)	100-104	1714N+1706+9013

Permette combinazione con laterale fisso STD nel lato porta, l'estensibilità minima del frontale aumenta di 0,7 cm

Descrizione	Art.
Profilo porta (riduce fino 1 cm l'estensione)	9014
Profilo espansione lato vetro +2,5 cm	9015
Magnete di espansione +1,2 cm	1221
Prof. esp. lato prof. a chiusura magnetica +3cm	9016



Opzione porte su misura (vedi pag. 289)

Descrizione	Art.
Porta < 80 cm	1338

GLASS PIEGHEVOLE + lat. fisso



COMBI 1 + LATERALE FISSO 70 C/BRACCETTO 1715

Cm	Estensibilità	Art.
60 (30+30)x70	57-58,5/66-69	1712+1725+1720F+1715
70 (40+30)x70	67-68,5/66-69	1713+1725+1720F+1715
75 (40+35)x70	72-73,5/66-69	1713+1727+1720F+1715
80 (40+40)x70	77-78,5/66-69	1713+1726+1720F+1715
80 (50+30)x70	77-78,5/66-69	1714+1725+1720F+1715
85 (50+35)x70	82-83,5/66-69	1714+1727+1720F+1715
90 (50+40)x70	87-88,5/66-69	1714+1726+1720F+1715
95 (50+45)x70	92-93,5/66-69	1714+1728+1720F+1715
100 (50+50)x70	97-98,5/66-69	1714+1706+1720F+1715

COMBI 1 + LATERALE FISSO 80 C/BRACCETTO

Cm	Estensibilità	Art.
60 (30+30)x80	57-58,5/76-79	1712+1725+1721F+1715
70 (40+30)x80	67-68,5/76-79	1713+1725+1721F+1715
75 (40+35)x80	72-73,5/76-79	1713+1727+1721F+1715
80 (40+40)x80	77-78,5/76-79	1713+1726+1721F+1715
80 (50+30)x80	77-78,5/76-79	1714+1725+1721F+1715
85 (50+35)x80	82-83,5/76-79	1714+1727+1721F+1715
90 (50+40)x80	87-88,5/76-79	1714+1726+1721F+1715
95 (50+45)x80	92-93,5/76-79	1714+1728+1721F+1715
100 (50+50)x80	97-98,5/76-79	1714+1706+1721F+1715

COMBI 1 + LATERALE FISSO 90 C/BRACCETTO 1715

Cm	Estensibilità	Art.
60 (30+30)x90	57-58,5/86-89	1712+1725+1722F+1715
70 (40+30)x90	67-68,5/86-89	1713+1725+1722F+1715
75 (40+35)x90	72-73,5/86-89	1713+1727+1722F+1715
80 (40+40)x90	77-78,5/86-89	1713+1726+1722F+1715
80 (50+30)x90	77-78,5/86-89	1714+1725+1722F+1715
85 (50+35)x90	82-83,5/86-89	1714+1727+1722F+1715
90 (50+40)x90	87-88,5/86-89	1714+1726+1722F+1715
95 (50+45)x90	92-93,5/86-89	1714+1728+1722F+1715
100 (50+50)x90	97-98,5/86-89	1714+1706+1722F+1715

Laterali fissi GLASS PIEGHEVOLE 6 mm

Descrizione	Estensibilità	Art.
Laterale fisso 70	66 - 69	1720F
Laterale fisso 80	76 - 79	1721F
Laterale fisso 90	86 - 89	1722F

Descrizione	Art.
Profilo espansione +2 cm	0218
Profilo espansione +4 cm	0029

Opzione braccetto

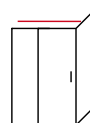

**Barra 140 con supporto
art. 1716+1718
(sostituire il art. 1715)**

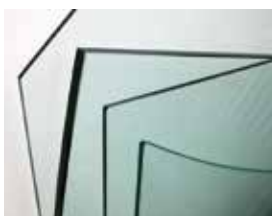

Lati fissi su misura 6 mm (maggiori informazioni a pagina 291)

Descrizione	Art.
Laterale fisso su misura GLASS PIEGHEVOLE fino 40 cm	1380
Laterale fisso su misura GLASS PIEGHEVOLE da 40 fino 80 cm	1381
Laterale fisso su misura GLASS PIEGHEVOLE da 80 fino 120 cm	1382

*Tempo di consegna 3 settimane

GLASS PIEGHEVOLE NERA + lat. fisso



COMBI 1 + LATERALE FISSO 70 C/BRACCETTO

Cm	Estensibilità	Art.
60 (30+30)x70	57-58,5/66-69	1712N+1725+1720FN+1715N
70 (40+30)x70	67-68,5/66-69	1713N+1725+1720FN+1715N
75 (40+35)x70	72-73,5/66-69	1713N+1727+1720FN+1715N
80 (40+40)x70	77-78,5/66-69	1713N+1726+1720FN+1715N
80 (50+30)x70	77-78,5/66-69	1714N+1725+1720FN+1715N
85 (50+35)x70	82-83,5/66-69	1714N+1727+1720FN+1715N
90 (50+40)x70	87-88,5/66-69	1714N+1726+1720FN+1715N
95 (50+45)x70	92-93,5/66-69	1714N+1728+1720FN+1715N
100 (50+50)x70	97-98,5/66-69	1714N+1706+1720FN+1715N

COMBI 1 + LATERALE FISSO 80 C/BRACCETTO

Cm	Estensibilità	Art.
60 (30+30)x80	57-58,5/76-79	1712N+1725+1721FN+1715N
70 (40+30)x80	67-68,5/76-79	1713N+1725+1721FN+1715N
75 (40+35)x80	72-73,5/76-79	1713N+1727+1721FN+1715N
80 (40+40)x80	77-78,5/76-79	1713N+1726+1721FN+1715N
80 (50+30)x80	77-78,5/76-79	1714N+1725+1721FN+1715N
85 (50+35)x80	82-83,5/76-79	1714N+1727+1721FN+1715N
90 (50+40)x80	87-88,5/76-79	1714N+1726+1721FN+1715N
95 (50+45)x80	92-93,5/76-79	1714N+1728+1721FN+1715N
100 (50+50)x80	97-98,5/76-79	1714N+1706+1721FN+1715N

COMBI 1 + LATERALE FISSO 90 C/BRACCETTO

Cm	Estensibilità	Art.
60 (30+30)x90	57-58,5/86-89	1712N+1725+1722FN+1715N
70 (40+30)x90	67-68,5/86-89	1713N+1725+1722FN+1715N
75 (40+35)x90	72-73,5/86-89	1713N+1727+1722FN+1715N
80 (40+40)x90	77-78,5/86-89	1713N+1726+1722FN+1715N
80 (50+30)x90	77-78,5/86-89	1714N+1725+1722FN+1715N
85 (50+35)x90	82-83,5/86-89	1714N+1727+1722FN+1715N
90 (50+40)x90	87-88,5/86-89	1714N+1726+1722FN+1715N
95 (50+45)x90	92-93,5/86-89	1714N+1728+1722FN+1715N
100 (50+50)x90	97-98,5/86-89	1714N+1706+1722FN+1715N

Lati fissi GLASS PIEGHEVOLE NERA 6 mm

Descrizione	Estensibilità	Art.
Laterale fisso 70	66 - 69	1720FN
Laterale fisso 80	76 - 79	1721FN
Laterale fisso 90	86 - 89	1722FN

Opzione braccetto

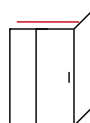

Barra 140 con supporto
art. 9026+9028
(sostituire il art. 1715N)

Descrizione	Art.
Profilo espansione nero+2 cm	9016



Lati fissi su misura 6 mm (maggiori informazioni a pagina 291)

Descrizione	Art.
Lat. fisso su misura GLASS PIEGHEVOLE NERA fino 40 cm	1380N
Lat. fisso su misura GLASS PIEGHEVOLE NERA da 40 fino 80 cm	1381N
Lat. fisso su misura GLASS PIEGHEVOLE NERA da 80 fino 120 cm	1382N

*Tempo di consegna 3 settimane

AKORD pieghevole



Frontali AKORD

Estensibilità	Apertura	Art.
66-71	50	0830
76-81	60	0831
86-91	70	0832
96-101	80	0833

Descrizione	Art.
Profilo espansione +2 cm	0218
Profilo espansione +4 cm	0029



Sistema di ante pieghevoli

Combinazioni AKORD + Laterale fisso STD

Estensibilità	Art.
66,4-68,9/66-69	0830+0814
76,4-78,9/66-69	0831+0814
86,4-88,9/66-69	0832+0814
96,4-98,9/66-69	0833+0814
Estensibilità	Art.
66,4-68,9/76-79	0830+0815
76,4-78,9/76-79	0831+0815
86,4-88,9/76-79	0832+0815
96,4-98,9/76-79	0833+0815

*Si può abbinare con il laterale fisso STD (vedi pag. 198)

Descrizione	Art.
Profilo espansione +2 cm	0218
Profilo espansione +4 cm	0029

SPAZIO COMBI A



PIEGHEVOLE

Cm	Apertura	Estensibilità	CROMO	NERO
			Art.	Art.
65	49	62,5-64	1260+1215	1260N+9014
65	49	63,5-65	1260+1211	1260N+9012
70	54	68-69,5	1261+1215	1261N+9014
70	54	69-70,5	1261+1211	1261N+9012
75	60	73,5-75	1262+1215	1262N+9014
75	60	74,5-76	1262+1211	1262N+9012

Descrizione	Art.
Profilo espansione porta cromo (+1cm oltre la dim. massima + espandibile 2,5cm)	1222
Profilo espansione porta nero (+1cm oltre la dim. massima + espandibile 2,5cm)	9015

Esempi: combinazione 1260+1211 (rango 63,5-65). Aggiunta profilo 1222 la nuova estensibilità sarà 66-68,5cm

1222

9015



La profondità deve essere = o > della misura massima della porta.

SPAZIO

COMBI A + Laterale fisso



Cm	Apert.	Estensibilità	CROMO	NERO
			Art.	Art.
65x70	49	62,5-64/66,5-69	1260+1215+1263	1260N+9014+1263N
65x70	49	63,5-65/66,5-69	1260+1211+1263	1260N+9012+1263N
65x80	49	62,5-64/76,5-79	1260+1215+1264	1260N+9014+1264N
65x80	49	63,5-65/76,5-79	1260+1211+1264	1260N+9012+1264N
70x80	54	68-69,5/76,5-79	1261+1215+1264	1261N+9014+1264N
70x80	54	69-70,5/76,5-79	1261+1211+1264	1261N+9012+1264N
75x80	60	73,5-75/76,5-79	1262+1215+1264	1262N+9014+1264N
75x80	60	74,5-76/76,5-79	1262+1211+1264	1262N+9012+1264N
65x90	49	62,5-64/86,5-89	1260+1215+1265	1260N+9014+1265N
65x90	49	63,5-65/86,5-89	1260+1211+1265	1260N+9012+1265N
70x90	54	68-69,5/86,5-89	1261+1215+1265	1261N+9014+1265N
70x90	54	69-70,5/86,5-89	1261+1211+1265	1261N+9012+1265N
75x90	60	73,5-75/86,5-89	1262+1215+1265	1262N+9014+1265N
75x90	60	74,5-76/86,5-89	1262+1211+1265	1262N+9012+1265N

*Può essere installato con laterale fisso su entrambi i lati, consultare fabbrica.

Descrizione	Art.
Profilo espansione laterale fisso +3 cm	0218
Profilo espansione laterale fisso +6 cm	0029
Profilo espansione porta cromo (+1cm oltre la dim. massima + espandibile 2,5cm)	1222
Profilo espansione porta nero (+1cm oltre la dim. massima + espandibile 2,5cm)	9015

*Esempi: combinazione 1260+1211 (rango 63,5-65). Aggiunta profilo 1222 la nuova estensibilità sarà 66-68,5cm

SPAZIO COMBI B



Cm	Ap.	Est	Fisso	Porta	CROMO	NERO
					Art.	Art.
85	49	79,5-82	20	65	1200+1260	9024+1260N
90	54	84,5-87	20	70	1200+1261	9024+1261N
90	49	84,5-87	25	65	1201+1260	9025+1260N
95	60	90-92,5	20	75	1200+1262	9024+1262N
95	54	90-92,5	25	70	1201+1261	9025+1261N
95	49	90-92,5	30	65	1202+1260	9000+1260N
100	60	95-97,5	25	75	1201+1262	9025+1262N
100	54	95-97,5	30	70	1202+1261	9000+1261N
105	49	100,5-103	40	65	1203+1260	9001+1260N
105	60	100,5-103	30	75	1202+1262	9000+1262N
110	54	105-107,5	40	70	1203+1261	9001+1261N
115	49	109,5-112	50	65	1204+1260	9002+1260N
115	60	109,5-112	40	75	1203+1262	9001+1262N
120	54	115-117,5	50	70	1204+1261	9002+1261N
125	49	120,5-123	60	65	1205+1260	9003+1260N
125	60	120,5-123	50	75	1204+1262	9002+1262N
125	54	125-127,5	60	70	1205+1261	9003+1261N
135	60	130,5-133	60	75	1205+1262	9003+1262N

Descrizione	Art.
Profilo espansione lat. fisso +3 cm	0218
Profilo espansione lat. fisso +6 cm	0029

La profondità deve essere = o > della misura massima della porta.

SPAZIO COMBI B + Laterale fisso





combinazioni frontali **SPAZIO** + laterale fisso

Cm	Apertura	Estensibilità	Fisso	Porta	Art.
85x70	49	79,5-82/66,5-69	20	65	1200+1260+1263
90x70	49	84,5-87/66,5-69	25	65	1201+1260+1263
95x70	49	90-92,5/66,5-69	30	65	1202+1260+1263
105x70	49	100,5-103/66,5-69	40	65	1203+1260+1263
115x70	49	109,5-112/66,5-69	50	65	1204+1260+1263
125x70	49	120,5-123/66,5-69	60	65	1205+1260+1263
85x80	49	79,5-82/76,5-79	20	65	1200+1260+1264
90x80	54	84,5-87/76,5-79	20	70	1200+1261+1264
90x80	49	84,5-87/76,5-79	25	65	1201+1260+1264
95x80	60	90-92,5/76,5-79	20	75	1200+1262+1264
95x80	54	90-92,5/76,5-79	25	70	1201+1261+1264
95x80	49	90-92,5/76,5-79	30	65	1202+1260+1264
100x80	60	95-97,5/76,5-79	25	75	1201+1262+1264
100x80	54	95-97,5/76,5-79	30	70	1202+1261+1264
105x80	49	100,5-103/76,5-79	40	65	1203+1260+1264
105x80	60	100,5-103/76,5-79	30	75	1202+1262+1264
110x80	54	105-107,5/76,5-79	40	70	1203+1261+1264
115x80	49	109,5-112/76,5-79	50	65	1204+1260+1264
115x80	60	109,5-112/76,5-79	40	75	1203+1262+1264
120x80	54	115-117,5/76,5-79	50	70	1204+1261+1264
125x80	49	120,5-123/76,5-79	60	65	1205+1260+1264
125x80	60	120,5-123/76,5-79	50	75	1204+1262+1264
130x80	54	125-127,5/76,5-79	60	70	1205+1261+1264
135x80	60	130,5-133/76,5-79	60	75	1205+1262+1264
85x90	49	79,5-82/86,5-89	20	65	1200+1260+1265
90x90	54	84,5-87/86,5-89	20	70	1200+1261+1265
90x90	49	84,5-87/86,5-89	25	65	1201+1260+1265
95x90	60	90-92,5/86,5-89	20	75	1200+1262+1265
95x90	54	90-92,5/86,5-89	25	70	1201+1261+1265
95x90	49	90-92,5/86,5-89	30	65	1202+1260+1265
100x90	60	95-97,5/86,5-89	25	75	1201+1262+1265
100x90	54	95-97,5/86,5-89	30	70	1202+1261+1265
105x90	49	100,5-103/86,5-89	40	65	1203+1260+1265
105x90	60	100,5-103/86,5-89	30	75	1202+1262+1265
110x90	54	105-107,5/86,5-89	40	70	1203+1261+1265
115x90	49	109,5-112/86,5-89	50	65	1204+1260+1265
115x90	60	109,5-112/86,5-89	40	75	1203+1262+1265
120x90	54	115-117,5/86,5-89	50	70	1204+1261+1265
125x90	49	120,5-123/86,5-89	60	65	1205+1260+1265
125x90	60	120,5-123/86,5-89	50	75	1204+1262+1265
130x90	54	125-127,5/86,5-89	60	70	1205+1261+1265
135x90	60	130,5-133/86,5-89	60	75	1205+1262+1265

*Può essere installato con laterale fisso su entrambi i lati, consultare fabbrica.



Descrizione	Art.
Lati fissi su misura <40cm	1345SP
Lati fissi su misura da 40cm fino 90cm	1316SP
Lati fissi su misura da >90cm fino 120cm	1317SP

PIEGHEVOLE

SPAZIO COMBI B + Laterale fisso nero





combinazioni frontali SPAZIO + laterale fisso

Cm	Apertura	Estensibilità	Fisso	Porta	Art.
85x70	49	79,5-82/66,5-69	20	65	9024+1260N+1263N
90x70	49	84,5-87/66,5-69	25	65	9025+1260N+1263N
95x70	49	90-92,5/66,5-69	30	65	9000+1260N+1263N
105x70	49	100,5-103/66,5-69	40	65	9001+1260N+1263N
115x70	49	109,5-112/66,5-69	50	65	9002+1260N+1263N
125x70	49	120,5-123/66,5-69	60	65	9003+1260N+1263N
85x80	49	79,5-82/76,5-79	20	65	9024+1260N+1264N
90x80	54	84,5-87/76,5-79	20	70	9024+1261N+1264N
90x80	49	84,5-87/76,5-79	25	65	9025+1260N+1264N
95x80	60	90-92,5/76,5-79	20	75	9024+1262N+1264N
95x80	54	90-92,5/76,5-79	25	70	9025+1261N+1264N
95x80	49	90-92,5/76,5-79	30	65	9000+1260N+1264N
100x80	60	95-97,5/76,5-79	25	75	9025+1262N+1264N
100x80	54	95-97,5/76,5-79	30	70	9000+1261N+1264N
105x80	49	100,5-103/76,5-79	40	65	9001+1260N+1264N
105x80	60	100,5-103/76,5-79	30	75	9000+1262N+1264N
110x80	54	105-107,5/76,5-79	40	70	9001+1261N+1264N
115x80	49	109,5-112/76,5-79	50	65	9002+1260N+1264N
115x80	60	109,5-112/76,5-79	40	75	9001+1262N+1264N
120x80	54	115-117,5/76,5-79	50	70	9002+1261N+1264N
125x80	49	120,5-123/76,5-79	60	65	9003+1260N+1264N
125x80	60	120,5-123/76,5-79	50	75	9002+1262N+1264N
130x80	54	125-127,5/76,5-79	60	70	9003+1261N+1264N
135x80	60	130,5-133/76,5-79	60	75	9003+1262N+1264N
85x90	49	79,5-82/86,5-89	20	65	9024+1260N+1265N
90x90	54	84,5-87/86,5-89	20	70	9024+1261N+1265N
90x90	49	84,5-87/86,5-89	25	65	9025+1260N+1265N
95x90	60	90-92,5/86,5-89	20	75	9024+1262N+1265N
95x90	54	90-92,5/86,5-89	25	70	9025+1261N+1265N
95x90	49	90-92,5/86,5-89	30	65	9000+1260N+1265N
100x90	60	95-97,5/86,5-89	25	75	9025+1262N+1265N
100x90	54	95-97,5/86,5-89	30	70	9000+1261N+1265N
105x90	49	100,5-103/86,5-89	40	65	9001+1260N+1265N
105x90	60	100,5-103/86,5-89	30	75	9000+1262N+1265N
110x90	54	105-107,5/86,5-89	40	70	9001+1261N+1265N
115x90	49	109,5-112/86,5-89	50	65	9002+1260N+1265N
115x90	60	109,5-112/86,5-89	40	75	9001+1262N+1265N
120x90	54	115-117,5/86,5-89	50	70	9002+1261N+1265N
125x90	49	120,5-123/86,5-89	60	65	9003+1260N+1265N
125x90	60	120,5-123/86,5-89	50	75	9002+1262N+1265N
130x90	54	125-127,5/86,5-89	60	70	9003+1261N+1265N
135x90	60	130,5-133/86,5-89	60	75	9003+1262N+1265N

*Può essere installato con laterale fisso su entrambi i lati, consultare fabbrica.



Descrizione	Art.
Lati fissi su misura fino <40cm	1345NSP
Lati fissi su misura da 40cm fino 90cm	1316NSP
Lati fissi su misura da >90cm fino 120cm	1317NSP

TANDEM fisso + scorrevole e pieghevole



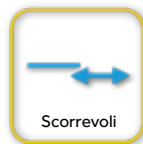

combinazioni TANDEM angolare

F+CxPleg.	Ap.	Estensibilità	Art.	F+CxPleg.	Ap.	Estensibilità	Art.
70x70	59	63-68 / 66,5-69,5	5018+5423+1740	70x75	66	63-68 / 71,5-74,5	5018+5423+1743
75x70	59	68-73 / 66,5-69,5	5029+5423+1740	75x75	67	68-73 / 71,5-74,5	5029+5423+1743
80x70	61	73-78 / 66,5-69,5	5019+5423+1740	80x75	68	73-78 / 71,5-74,5	5019+5423+1743
85x70	63	78-83 / 66,5-69,5	5030+5423+1740	85x75	69	78-83 / 71,5-74,5	5030+5423+1743
90x70	64	83-88 / 66,5-69,5	5020+5423+1740	90x75	70	83-88 / 71,5-74,5	5020+5423+1743
95x70	66	88-93 / 66,5-69,5	5031+5423+1740	95x75	72	88-93 / 71,5-74,5	5031+5423+1743
100x70	67	93-98 / 66,5-69,5	5021+5423+1740	100x75	73	93-98 / 71,5-74,5	5021+5423+1743
110x70	68	102-107 / 66,5-69,5	5002+5423+1740	110x75	74	102-107 / 71,5-74,5	5002+5423+1743
120x70	73	113-118 / 66,5-69,5	5022+5423+1740	120x75	79	113-118 / 71,5-74,5	5022+5423+1743
130x70	74	122-127 / 66,5-69,5	5006+5424+1740	130x75	80	122-127 / 71,5-74,5	5006+5424+1743
140x70	78	132-137 / 66,5-69,5	5008+5424+1740	140x75	83	132-137 / 71,5-74,5	5008+5424+1743
F+CxPleg.	Ap.	Estensibilità	Art.	F+CxPleg.	Ap.	Estensibilità	Art.
70x80	68	63-68 / 76,5-79,5	5018+5423+1741	70x90	77	63-68 / 86,5-89,5	5018+5423+1742
75x80	68	68-73 / 76,5-79,5	5029+5423+1741	75x90	77	68-73 / 86,5-89,5	5029+5423+1742
80x80	70	73-78 / 76,5-79,5	5019+5423+1741	80x90	79	73-78 / 86,5-89,5	5019+5423+1742
85x80	71	78-83 / 76,5-79,5	5030+5423+1741	85x90	80	78-83 / 86,5-89,5	5030+5423+1742
90x80	72	83-88 / 76,5-79,5	5020+5423+1741	90x90	81	83-88 / 86,5-89,5	5020+5423+1742
95x80	74	88-93 / 76,5-79,5	5031+5423+1741	95x90	82	88-93 / 86,5-89,5	5031+5423+1742
100x80	75	93-98 / 76,5-79,5	5021+5423+1741	100x90	83	93-98 / 86,5-89,5	5021+5423+1742
110x80	76	102-107 / 76,5-79,5	5002+5423+1741	110x90	84	102-107 / 86,5-89,5	5002+5423+1742
120x80	81	113-118 / 76,5-79,5	5022+5423+1741	120x90	88	113-118 / 86,5-89,5	5022+5423+1742
130x80	82	122-127 / 76,5-79,5	5006+5424+1741	130x90	89	122-127 / 86,5-89,5	5006+5424+1742
140x80	85	132-137 / 76,5-79,5	5008+5424+1741	140x90	92	132-137 / 86,5-89,5	5008+5424+1742

Si possono combinare frontali Basic di misure intermedie, estensibilità +2 cm.

Descrizione	Art.
Profilo espansione +1,5 cm per laterale fisso + scorrevole	5429
Profilo espansione +2,5 per lato pieghevole	1222



Box doccia su misura e cristalli speciali

Box doccia su misura +45%

Si può fabbricare su misura il lato fisso e scorrevole, la porta del lato pieghevole con altezza di 195 cm.

*Tempo di consegna 3 settimane

GME

TRIO pg.256
1 fisso e 2 scorrevoli



TRIO NERA pg.258
1 fisso e 2 scorrevoli



BYPASS pg.260
2 scorrevoli



PORTE DIVISORIE pg.262
Scorrevoli



+SOLUZIONI+

TRIO 1 fisso + 2 scorrevoli

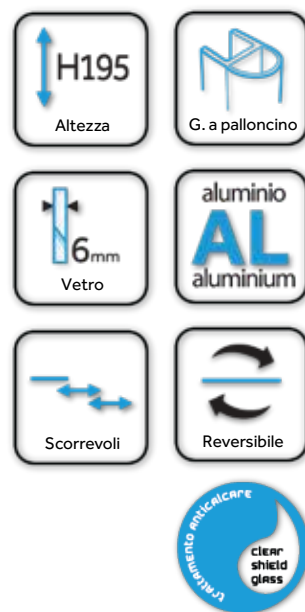

Adorno in alluminio

Descrizione	Estensibilità	Apertura	Art.
Frontale 1F+2S TRIO 90	86-91	43-45	1230
Frontale 1F+2S TRIO 95	91-96	46-48	1231
Frontale 1F+2S TRIO 100	96-101	49-51	1232
Frontale 1F+2S TRIO 105	101-106	53-55	1233
Frontale 1F+2S TRIO 110	106-111	56-58	1234
Frontale 1F+2S TRIO 115	111-116	59-61	1235
Frontale 1F+2S TRIO 120	116-121	63-65	1236
Frontale 1F+2S TRIO 125	121-126	66-68	1237
Frontale 1F+2S TRIO 130	126-131	69-71	1238
Frontale 1F+2S TRIO 135	131-136	73-75	1239
Frontale 1F+2S TRIO 140	136-141	76-78	1240
Frontale 1F+2S TRIO 145	141-146	79-81	1243
Frontale 1F+2S TRIO 150	146-151	82-84	1244
Frontale 1F+2S TRIO 155	151-156	85-88	1245
Frontale 1F+2S TRIO 160	156-161	89-91	1246
Adorno in alluminio 195x3,8 cm			0007

TRIO frontale + laterale fisso



Cm	Estensibilità	Art.	Cm	Estensibilità	Art.
90x70	87-89,5 / 67-69,5	1230 + 1241	90x80	87-89,5 / 77-79,5	1230 + 1242
95x70	92-94,5 / 67-69,5	1231 + 1241	95x80	92-94,5 / 77-79,5	1231 + 1242
100x70	97-99,5 / 67-69,5	1232 + 1241	100x80	97-99,5 / 77-79,5	1232 + 1242
105x70	102-104,5 / 67-69,5	1233 + 1241	105x80	102-104,5 / 77-79,5	1233 + 1242
110x70	107-109,5 / 67-69,5	1234 + 1241	110x80	107-109,5 / 77-79,5	1234 + 1242
115x70	112-114,5 / 67-69,5	1235 + 1241	115x80	112-114,5 / 77-79,5	1235 + 1242
120x70	117-119,5 / 67-69,5	1236 + 1241	120x80	117-119,5 / 77-79,5	1236 + 1242
125x70	122-124,5 / 67-69,5	1237 + 1241	125x80	122-124,5 / 77-79,5	1237 + 1242
130x70	127-129,5 / 67-69,5	1238 + 1241	130x80	127-129,5 / 77-79,5	1238 + 1242
135x70	132-134,5 / 67-69,5	1239 + 1241	135x80	132-134,5 / 77-79,5	1239 + 1242
140x70	137-139,5 / 67-69,5	1240 + 1241	140x80	137-139,5 / 77-79,5	1240 + 1242
145x70	142-144,5 / 67-69,5	1243 + 1241	145x80	142-144,5 / 77-79,5	1243 + 1242
150x70	147-149,5 / 67-69,5	1244 + 1241	150x80	147-149,5 / 77-79,5	1244 + 1242
155x70	152-154,5 / 67-69,5	1245 + 1241	155x80	152-154,5 / 77-79,5	1245 + 1242
160x70	157-159,5 / 67-69,5	1246 + 1241	160x80	157-159,5 / 77-79,5	1246 + 1242

Descrizione	Art.
Profilo espansione +3 cm solo per laterale fisso	0218
Profilo espansione +6 cm solo per laterale fisso	0029



Lati fissi su misura TRIO (maggiori informazioni a pagina 291)

Descrizione	Art.
Laterale fisso su misura fino 40 cm	1342
Laterale fisso su misura da 40 fino 80 cm	1303
Laterale fisso su misura da 80 fino 120 cm	1309

*Tempo di consegna 3 settimane

TRIO NERA 1 fisso + 2 scorrevoli



Descrizione	Estensibilità	Apertura	Art.
Frontale 1F+2S TRIO NERA 100	96-101	49-51	1232N
Frontale 1F+2S TRIO NERA 105	101-106	53-55	1233N
Frontale 1F+2S TRIO NERA 110	106-111	56-58	1234N
Frontale 1F+2S TRIO NERA 115	111-116	59-61	1235N
Frontale 1F+2S TRIO NERA 120	116-121	63-65	1236N
Adorno in alluminio nero 195x3,8 cm			0007N
Opzione guarnizioni verticali nere			0014

TRIO NERA frontale + laterale fisso



Cm	Estensibilità	Art.
100x70	97-99,5 / 67-69,5	1232N+1241N
105x70	102-104,5 / 67-69,5	1233N+1241N
110x70	107-109,5 / 67-69,5	1234N+1241N
115x70	112-114,5 / 67-69,5	1235N+1241N
120x70	117-119,5 / 67-69,5	1236N+1241N
100x80	97-99,5 / 77-79,5	1232N+1242N
105x80	102-104,5 / 77-79,5	1233N+1242N
110x80	107-109,5 / 77-79,5	1234N+1242N
115x80	112-114,5 / 77-79,5	1235N+1242N
120x80	117-119,5 / 77-79,5	1236N+1242N

Le aperture sono le stesse dei frontali.

Descrizione	Art.
Profilo espansione +3 cm solo per laterale fisso	9016

Lati fissi su misura TRIO NERA (maggiori informazioni a pagina 291)

Descrizione	Art.
Laterale fisso su misura fino 40 cm	1342N
Laterale fisso su misura da 40 fino 80 cm	1303N
Laterale fisso su misura da 80 fino 120 cm	1309N

*Tempo di consegna 3 settimane

BYPASS 2 scorrevoli



Descrizione	Estensibilità	Apertura	Art.
Frontale BYPASS 140	128 - 138	55-65	1272
Frontale BYPASS 150	138 - 148	60-70	1273
Frontale BYPASS 160	148 - 158	65-75	1274



Sistema di quattro ruote per cuscinetto

BYPASS frontale + laterale fisso

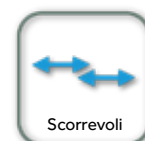

Lati fissi BYPASS

Descrizione	Estensibilità	Art.
Laterale fisso BYPASS 70	66-69	1275
Laterale fisso BYPASS 80	76-79	1276

Combinazioni frontali BYPASS + laterale fisso

Cm	Estensibilità	Art.	P	Cm	Estensibilità	Art.
140x70	130-140/66-69	1272 + 1275	1258	140x80	130-140/76-79	1272 + 1276
150x70	140-150/66-69	1273 + 1275	1280	150x80	140-150/76-79	1273 + 1276
160x70	150-160/66-69	1274 + 1275	1304	160x80	150-160/76-79	1274 + 1276

*Le aperture sono le stesse dei frontali.



Laterali fissi su misura (maggiori informazioni a pagina 290)

Descrizione	Art.
Laterale fisso su misura BYPASS fino 40 cm	1346
Laterale fisso su misura BYPASS da 40 fino 80 cm	1318
Laterale fisso su misura BYPASS da 80 fino 120 cm	1319

*Tempo di consegna 3 settimane

PORTE DIVISORIE CROMO

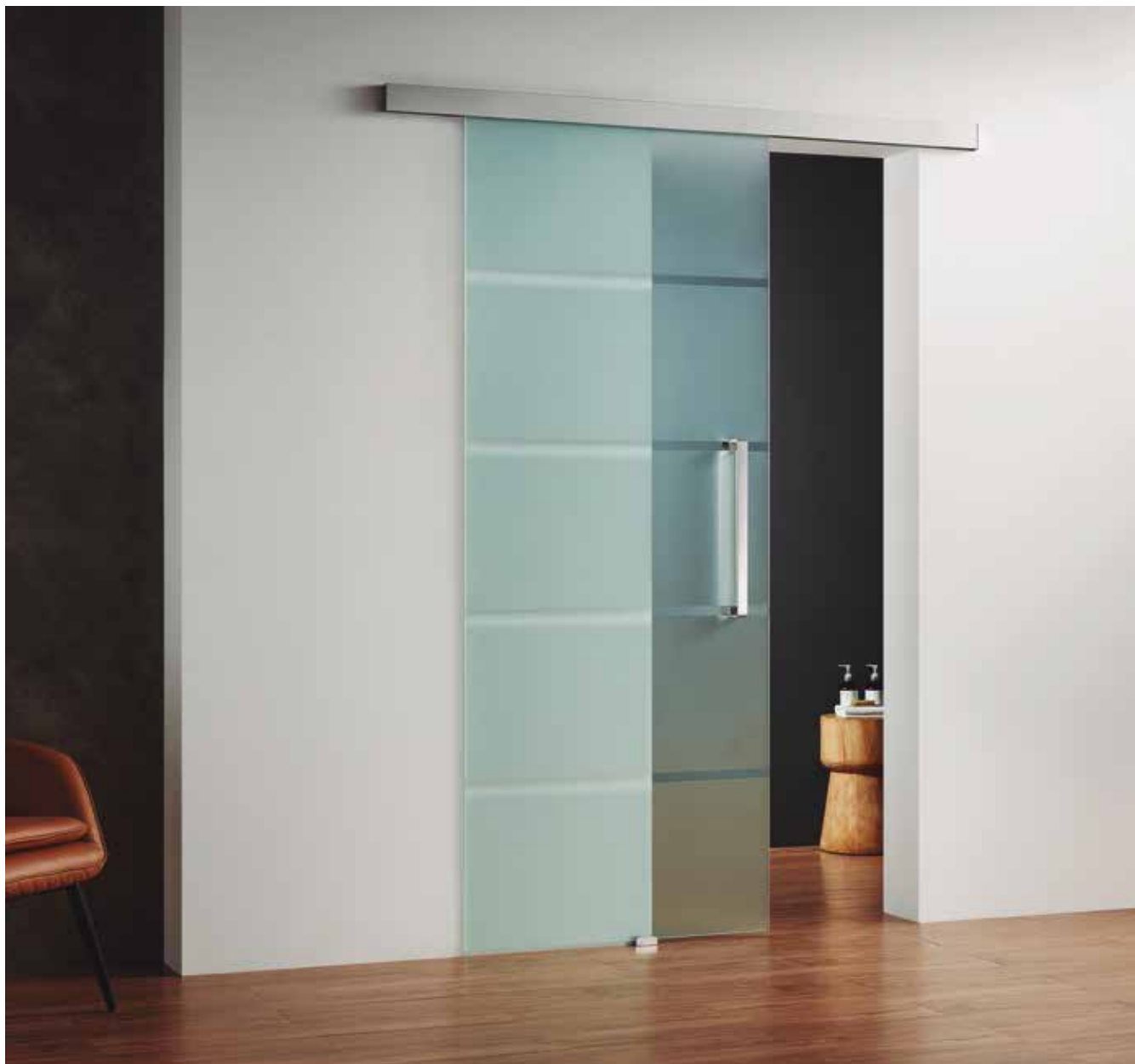

Descrizione	Art.
Porta da 75 cm + kit barra/guida 150 cm cromo	1750+1752
Porta da 85 cm + kit barra/guida 170 cm cromo	1751+1753

PORTE SU MISURA E SPECIALI	
TRASP.	OPACO
+45%	+60%

*Tempo di consegna 3 settimane

PORTE DIVISORIE NERE



+SOLUZIONI+

Descrizione	Art.
Porta da 75 cm + kit barra/guida 150 cm nera	1750+1754
Porta da 85 cm + kit barra/guida 170 cm nera	1751+1755

PORTE SU MISURA E SPECIALI	
TRASP.	OPACO
+45%	+60%

*Tempo di consegna 3 settimane

OPEN
pg.266 ● ●



OPEN 2
pg.268



GLASS PIEG.
pg.269



GME

FISSO SCREEN

pg.270 ● ● ● ● ● ● ● ●



BASIC

pg.274 ● ● ● ● ● ● ● ●



VASCA

PARETI PER VASCA

Open 1

A battente vasca

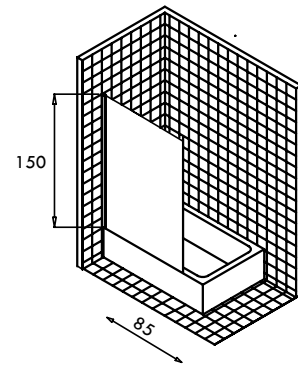

Open 1

Pannello vasca 85x150 cm

Descrizione	Art.
A battente 150x85 cm	0121

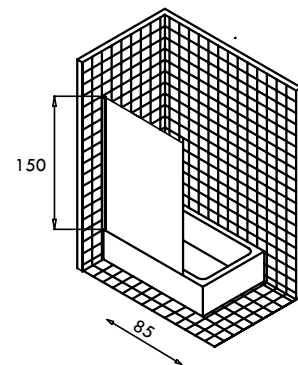

Open 1 Frost Plus

Pannello vasca 85x150 cm

Descrizione	Art.
A battente Frost Plus 150x85	0123

Open 1 Nero

Pannello vasca 85x150



Altezza



Vetro



A battente 180°



1.5cm

Espandibile

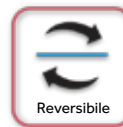

Reversibile

Descrizione

Art.

A battente 150x85 cm

0121N



Open 2

Pannello vasca



Open 2

Pannello vasca 150x122

Descrizione	Art.
Pannello Open 2 Trasparente	0120+0121

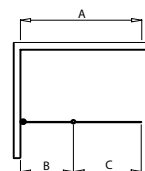
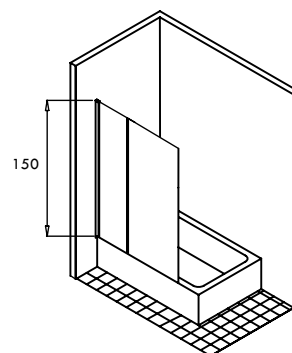

A	B	C
120	37	83

profilo alluminio cromo
 cristallo temperato 6mm
 elevazione al girare



Open 2 Frost Plus

Pannello vasca 150x122

Descrizione	Art.
Pannello Open 2 frost plus	0122+0123

Open 2 Nera

Pannello vasca 150x122



Descrizione	Art.
Panello Open 2 nero Trasparente	0120N+0121N





Glass pieghevole

94,5x150 cm (47+47)



Art.
1733

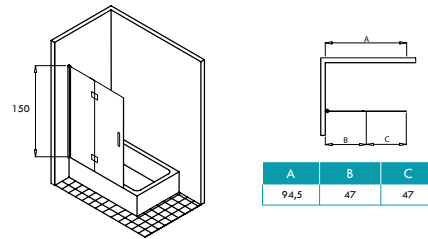

Screen

fissi vasca 150x85

Screen Cromo



Screen Cromo Frost



Descrizione	Art.
CROMO 150x85 cm	0118

Include braccio orientabile **diritto/45°** est. 60-120 cm

Descrizione	Art.
CROMO Frost 150x85 cm	0119

Include braccio orientabile **diritto/45°** est. 60-120 cm

Screen Nera



Descrizione	Art.
NERA 150x85 cm	0118N

Include braccio orientabile **diritto/45°** est. 60-120 cm

Screen Nera Frost



Descrizione	Art.
NERA Frost 150x85 cm	SC85FN

Include braccio orientabile **diritto/45°** est. 60-120 cm

Screen Bianca



Descrizione	Art.
BIANCA 150x85 cm	SC85B

Include braccio orientabile **diritto/45°** est. 60-120 cm

Screen Bianca Frost



Descrizione	Art.
BIANCA Frost 150x85 cm	SC85FB

Include braccio orientabile **diritto/45°** est. 60-120 cm

Screen colore

fissi vasca 150x85

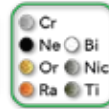

Screen Oro



Descrizione	Art.
ORO 150x85 cm	SC85OR

Include braccio orientabile **diritto/45°** est. 60-120 cm

Screen Oro Frost



Descrizione	Art.
ORO Frost 150x85 cm	SC85FOR

Include braccio orientabile **diritto/45°** est. 60-120 cm

Screen Nichel



Descrizione	Art.
NICHEL 150x85 cm	SC85NK

Include braccio orientabile **diritto/45°** est. 60-120 cm

Screen Nichel Frost



Descrizione	Art.
NICHEL Frost 150x85 cm	SC85FNK

Include braccio orientabile **diritto/45°** est. 60-120 cm

Screen colore

fissi vasca 150x85

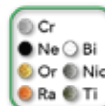
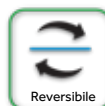

Screen Rame



Screen Rame Frost



Descrizione	Art.
RAME 150x85 cm	SC85CB

Include braccio orientabile **diritto/45°** est. 60-120 cm

Descrizione	Art.
RAME Frost 150x85 cm	SC85FCB

Include braccio orientabile **diritto/45°** est. 60-120 cm

Screen Titanio



Screen Titanio Frost



Descrizione	Art.
TITANIO 150x85 cm	SC85T

Include braccio orientabile **diritto/45°** est. 60-120 cm

Descrizione	Art.
TITANIO Frost 150x85 cm	SC85FT

Include braccio orientabile **diritto/45°** est. 60-120 cm

BASIC VASCA 1F+1S



Cm	Apert.	TRASPARENTE			FROST PLUS		
		CROM	NERO	BIAN	CROM	NERO	BIAN
140-145	56-61	5801	5801N	5801B	6801	6801N	6801B
145-150	61-66	5802	5802N	5802B	6802	6802N	6802B
150-155	61-66	5803	5803N	5803B	6803	6803N	6803B
155-160	66-71	5804	5804N	5804B	6804	6804N	6804B
160-165	61-66	5805	5805N	5805B	6805	6805N	6805B
165-170	66-71	5806	5806N	5806B	6806	6806N	6806B

Accessori
Profilo espansione +1,5 cm
Adorno in alluminio 195x3,8 cm

CROMO	NERO	BIANCO
5429	5477	5473
0007	0007N	0007B



SU MISURA
E SPECIALE
Vedi pag. 288

BASIC VASCA 1F+1S

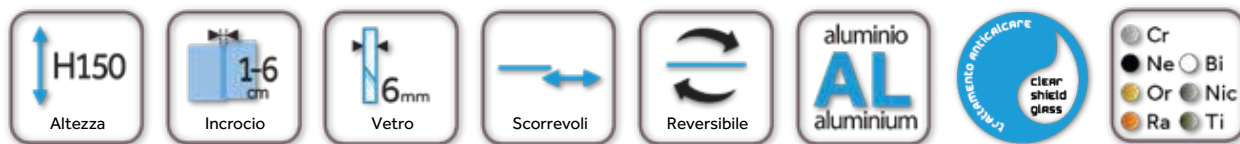

Cm	TRASPARENTE				FROST PLUS			
	ORO	NICH	RAME	TIT	ORO	NICH	RAME	TIT
140-145	5801OR	5801NK	5801CB	5801T	6801OR	6801NK	6801CB	6801T
145-150	5802OR	5802NK	5802CB	5802T	6802OR	6802NK	6802CB	6802T
150-155	5803OR	5803NK	5803CB	5803T	6803OR	6803NK	6803CB	6803T
155-160	5804OR	5804NK	5804CB	5804T	6804OR	6804NK	6804CB	6804T
160-165	5805OR	5805NK	5805CB	5805T	6805OR	6805NK	6805CB	6805T
165-170	5806OR	5806NK	5806CB	5806T	6806OR	6806NK	6806CB	6806T

Accessori	ORO	NICHEL	RAME	TITANIO
Profilo espansione +1,5 cm	5474	5475	5476	5478
Adorno in alluminio 195x3,8 cm	0007OR	0007NK	0007CB	0007T

BASIC VASCA + laterale fisso 8 mm

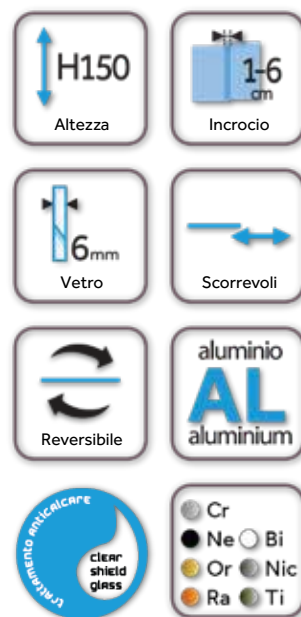

Laterali fissi vasca

Descrizione	Estensibilità
Laterale fisso BASIC 70x150	67-70
Laterale fisso BASIC 75x150	72-74

TRASPARENTE
Art.
5065CR
5066CR

FROST PLUS
Art.
6065CR
6066CR

combinazioni BASIC vasca + laterale fisso 8 mm

Cm	Estensibilità	Apertura
145x70	140-145/67-70	56-61
150x70	145-150/67-70	61-66
155x70	150-155/67-70	61-66
160x70	155-160/67-70	66-71
165x70	160-165/67-70	61-66
170x70	165-170/67-70	66-71
Cm	Estensibilità	Apertura
145x75	140-145/72-74	56-61
150x75	145-150/72-74	61-66
155x75	150-155/72-74	61-66
160x75	155-160/72-74	66-71
165x75	160-165/72-74	61-66
170x75	165-170/72-74	66-71

TRASPARENTE
Art.
5801+5065CR
5802+5065CR
5803+5065CR
5804+5065CR
5805+5065CR
5806+5065CR
Art.
5801+5066CR
5802+5066CR
5803+5066CR
5804+5066CR
5805+5066CR
5806+5066CR

FROST PLUS
Art.
6801+6065CR
6802+6065CR
6803+6065CR
6804+6065CR
6805+6065CR
6806+6065CR
Art.
6801+6066CR
6802+6066CR
6803+6066CR
6804+6066CR
6805+6066CR
6806+6066CR

*Opzione profilo di unione fisso-fisso cromo art. 0182 (indicare il verso).



Laterali fissi su misura

Descrizione
misura fino 40 cm
misura da 40 fino 80 cm
misura da 80 fino 120 cm

TRASPARENTE
Art.
1350
1334
1335

FROST PLUS
Art.
1350+1312
1334+1313
1335+1315

*Tempo di consegna 3 settimane

BASIC NERA/BIANCA + laterale fisso 8 mm



Laterali fissi vasca

Descrizione	Cm	TRASPARENTE		FROST PLUS	
		NERO	BIANCO	NERO	BIANCO
Laterale fisso BASIC 70x150	67-70	5065N	5065B	6065N	6065B
Laterale fisso BASIC 75x150	72-74	5066N	5066B	6066N	6066B

Cm (frontale/lat.fisso)	TRASPARENTE		FROST PLUS	
	NERO	BIANCO	NERO	BIANCO
140-145/67-70	5801N+5065N	5801B+5065B	6801N+6065N	6801B+6065B
145-150/67-70	5802N+5065N	5802B+5065B	6802N+6065N	6802B+6065B
150-155/67-70	5803N+5065N	5803B+5065B	6803N+6065N	6803B+6065B
155-160/67-70	5804N+5065N	5804B+5065B	6804N+6065N	6804B+6065B
160-165/67-70	5805N+5065N	5805B+5065B	6805N+6065N	6805B+6065B
165-170/67-70	5806N+5065N	5806B+5065B	6806N+6065N	6806B+6065B
Cm (frontale/lat.fisso)	NERO	BIANCO	NERO	BIANCO
140-145/72-74	5801N+5066N	5801B+5066B	6801N+6066N	6801B+6066B
145-150/72-74	5802N+5066N	5802B+5066B	6802N+6066N	6802B+6066B
150-155/72-74	5803N+5066N	5803B+5066B	6803N+6066N	6803B+6066B
155-160/72-74	5804N+5066N	5804B+5066B	6804N+6066N	6804B+6066B
160-165/72-74	5805N+5066N	5805B+5066B	6805N+6066N	6805B+6066B
165-170/72-74	5806N+5066N	5806B+5066B	6806N+6066N	6806B+6066B

*Opzione profilo di unione fisso-fisso nero art. 0991 (indicare il verso).

*Opzione profilo di unione fisso-fisso bianco art. 0182B (indicare il verso).



Lat. fissi su misura

Descrizione	TRASPARENTE		FROST PLUS	
	NERO	BIANCO	NERO	BIANCO
Fino a 40 cm	1350N	1350B	1350N+1312	1350B+1312
Da 40 fino 80 cm	1334N	1334B	1334N+1313	1334B+1313
Da 80 fino 120 cm	1335N	1335B	1335N+1315	1335B+1315

*Tempo di consegna 3 settimane

BASIC ORO/NICHEL + laterale fisso 8 mm



Lati fissi vasca

Descrizione	Cm
Laterale fisso BASIC 70x150	67-70
Laterale fisso BASIC 75x150	72-74

TRASPARENTE	
ORO	NICHEL
5065OR	5065NK
5066OR	5066NK

FROST PLUS	
ORO	NICHEL
6065OR	6065NK
6066OR	6066NK

Cm (frontale/lat.fisso)	TRASPARENTE		FROST PLUS	
	ORO	NICHEL	ORO	NICHEL
140-145/67-70	5801OR+5065OR	5801NK+5065NK	6801OR+6065OR	6801NK+6065NK
145-150/67-70	5802OR+5065OR	5802NK+5065NK	6802OR+6065OR	6802NK+6065NK
150-155/67-70	5803OR+5065OR	5803NK+5065NK	6803OR+6065OR	6803NK+6065NK
155-160/67-70	5804OR+5065OR	5804NK+5065NK	6804OR+6065OR	6804NK+6065NK
160-165/67-70	5805OR+5065OR	5805NK+5065NK	6805OR+6065OR	6805NK+6065NK
165-170/67-70	5806OR+5065OR	5806NK+5065NK	6806OR+6065OR	6806NK+6065NK
Cm (frontale/lat.fisso)	ORO	NICHEL	ORO	NICHEL
140-145/72-74	5801OR+5066OR	5801NK+5066NK	6801OR+6066OR	6801NK+6066NK
145-150/72-74	5802OR+5066OR	5802NK+5066NK	6802OR+6066OR	6802NK+6066NK
150-155/72-74	5803OR+5066OR	5803NK+5066NK	6803OR+6066OR	6803NK+6066NK
155-160/72-74	5804OR+5066OR	5804NK+5066NK	6804OR+6066OR	6804NK+6066NK
160-165/72-74	5805OR+5066OR	5805NK+5066NK	6805OR+6066OR	6805NK+6066NK
165-170/72-74	5806OR+5066OR	5806NK+5066NK	6806OR+6066OR	6806NK+6066NK

*Opzione profilo di unione fisso-fisso oro art. 0182OR (indicare il verso).

*Opzione profilo di unione fisso-fisso nichel art. 0182NK (indicare il verso).



Lat. fissi su misura

Descrizione
Fina a 40 cm
Da 40 fino 80 cm
Da 80 fino 120 cm

TRASPARENTE	
ORO	NICHEL
1350OR	1350NK
1334OR	1334NK
1335OR	1335NK

FROST PLUS	
ORO	NICHEL
1350OR+1312	1350NK+1312
1334OR+1313	1334NK+1313
1335OR+1315	1335NK+1315

*Tempo di consegna 3 settimane

BASIC RAME/TITANIO + laterale fisso 8 mm



Lati fissi vasca

Descrizione	Cm	TRASPARENTE		FROST PLUS	
		RAME	TITANIO	RAME	TITANIO
Laterale fisso BASIC 70x150	67-70	5065CB	5065T	6065CB	6065T
Laterale fisso BASIC 75x150	72-74	5066CB	5066T	6066CB	6066T

Cm (frontale/lat.fisso)	TRASPARENTE		FROST PLUS	
	RAME	TITANIO	RAME	TITANIO
140-145/67-70	5801CB+5065CB	5801T+5065T	6801CB+6065CB	6801T+6065T
145-150/67-70	5802CB+5065CB	5802T+5065T	6802CB+6065CB	6802T+6065T
150-155/67-70	5803CB+5065CB	5803T+5065T	6803CB+6065CB	6803T+6065T
155-160/67-70	5804CB+5065CB	5804T+5065T	6804CB+6065CB	6804T+6065T
160-165/67-70	5805CB+5065CB	5805T+5065T	6805CB+6065CB	6805T+6065T
165-170/67-70	5806CB+5065CB	5806T+5065T	6806CB+6065CB	6806T+6065T
Cm (frontale/lat.fisso)	RAME	TITANIO	RAME	TITANIO
140-145/72-74	5801CB+5066CB	5801T+5066T	6801CB+6066CB	6801T+6066T
145-150/72-74	5802CB+5066CB	5802T+5066T	6802CB+6066CB	6802T+6066T
150-155/72-74	5803CB+5066CB	5803T+5066T	6803CB+6066CB	6803T+6066T
155-160/72-74	5804CB+5066CB	5804T+5066T	6804CB+6066CB	6804T+6066T
160-165/72-74	5805CB+5066CB	5805T+5066T	6805CB+6066CB	6805T+6066T
165-170/72-74	5806CB+5066CB	5806T+5066T	6806CB+6066CB	6806T+6066T

*Opzione profilo di unione fisso-fisso rame art. 0182CB (indicare il verso).

*Opzione profilo di unione fisso-fisso titanio art. 0182T (indicare il verso).

Lat. fissi su misura	Descrizione	TRASPARENTE		FROST PLUS	
		RAME	TITANIO	RAME	TITANIO
	Fina a 40 cm	1350CB	1350T	1350CB+1312	1350T+1312
	Da 40 fino 80 cm	1334CB	1334T	1334CB+1313	1334T+1313
	Da 80 fino 120 cm	1335CB	1335T	1335CB+1315	1335T+1315

*Tempo di consegna 3 settimane

BASIC CROMO/NERA/BIANCA 2F+ 2S

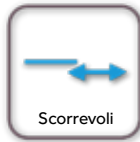

Cm	Apert.	TRASPARENTE			FROST PLUS		
		● CROM	● NERO	● BIAN	● CROM	● NERO	● BIAN
152-162	64-74	5810	5810N	5810B	6810	6810N	6810B
162-172	66-76	5811	5811N	5811B	6811	6811N	6811B
172-182	72-82	5812	5812N	5812B	6812	6812N	6812B

Accessori	CROMO	NERO	BIANCO
Profilo espansione +1,5 cm	5429	5477	5473
Adorno in alluminio 195x3,8 cm	0007	0007N	0007B
Profilo di unione fisso-fisso (indicare il verso)	0182	0991	0182B



SU MISURA
E SPECIALE
Vedi pag. 288

BASIC ORO/NICHEL/RAME/TITANIO 2F+ 2S



Cm	TRASPARENTE				FROST PLUS			
	ORO	NICH	RAME	TITA	ORO	NICH	RAME	TITA
152-162	5810OR	5810NK	5810CB	5810T	6810OR	6810NK	6810CB	6810T
162-172	5811OR	5811NK	5811CB	5811T	6811OR	6811NK	6811CB	6811T
172-182	5812OR	5812NK	5812CB	5812T	6812OR	6812NK	6812CB	6812T

Accessori	ORO	NICHEL	RAME	TITANIO
Profilo espansione +1,5 cm	5474	5475	5476	5478
Adorno in alluminio 195x3,8 cm	0007OR	0007NK	0007CB	0007T
Profilo di unione fisso-fisso (indicare il verso)	0182OR	0182NK	0182CB	0182T

BASIC VASCA + laterale fisso 8 mm

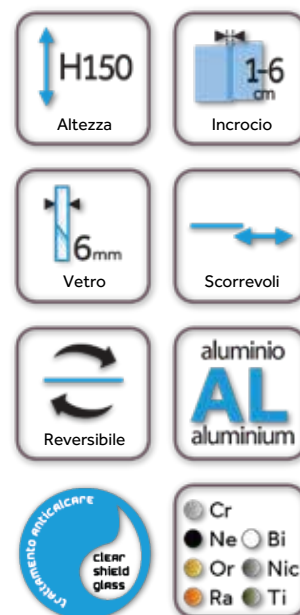

AL MOMENTO DELL'ORDINE, INDICARE SU QUALE LATO DEVE ESSERE INSTALLATO IL PANNELLO LATERALE FISSO.

Lati fissi vasca

Descrizione	Estensibilità
Laterale fisso BASIC 70x150	67-70
Laterale fisso BASIC 75x150	72-74

TRASPARENTE	FROST PLUS
Art.	Art.
5065CR	6065CR
5066CR	6066CR

combinazioni frontali BASIC 2F+2S + laterale fisso 8 mm

Cm	Estensibilità	Apertura	TRASPARENTE Art.	FROST PLUS Art.
160x70	152-162/67-69	64-74	5810+5065CR+0182	6810+6065CR+0182
170x70	162-172/67-69	66-76	5811+5065CR+0182	6811+6065CR+0182
180x70	172-182/67-69	72-82	5812+5065CR+0182	6812+6065CR+0182
Cm	Estensibilità	Apertura	TRASPARENTE Art.	FROST PLUS Art.
160x75	152-162/72-74	64-74	5810+5066CR+0182	6810+6066CR+0182
170x75	162-172/72-74	66-76	5811+5066CR+0182	6811+6066CR+0182
180x75	172-182/72-74	72-82	5812+5066CR+0182	6812+6066CR+0182

*Al momento dell'ordine, indicare su quale lato deve essere installato il pannello laterale fisso.



Laterali fissi su misura

Descrizione
misura fino 40 cm
misura da 40 fino 80 cm
misura da 80 fino 120 cm

TRASPARENTE	FROST PLUS
Art.	Art.
1350+0182	1350+0182+1312
1334+0182	1334+0182+1313
1335+0182	1335+0182+1315

Indicare dove va il laterale fisso. Tempo di consegna 3 settimane.

BASIC COLORE VASCA + laterale fisso 8 mm

PROFILI NERI



PROFILI BIANCHI



Lati fissi vasca

Descrizione	Cm
Laterale fisso BASIC 70x150	67-70
Laterale fisso BASIC 75x150	72-74

TRASPARENTE		FROST PLUS	
● NERO	● BIANCO	● NERO	● BIANCO
5065N	5065B	6065N	6065B
5066N	5066B	6066N	6066B

Estensibilità	TRASPARENTE		FROST PLUS	
	● NERO	● BIANCO	● NERO	● BIANCO
152-162/67-69	5810N+5065N+0991	5810B+5065B+0182B	6810N+6065N+0991	6810B+6065B+0182B
162-172/67-69	5811N+5065N+0991	5811B+5065B+0182B	6811N+6065N+0991	6811B+6065B+0182B
172-182/67-69	5812N+5065N+0991	5812B+5065B+0182B	6812N+6065N+0991	6812B+6065B+0182B
Estensibilità	● NERO	● BIANCO	● NERO	● BIANCO
152-162/72-74	5810N+5066N+0991	5810B+5066B+0182B	6810N+6066N+0991	6810B+6066B+0182B
162-172/72-74	5811N+5066N+0991	5811B+5066B+0182B	6811N+6066N+0991	6811B+6066B+0182B
172-182/72-74	5812N+5066N+0991	5812B+5066B+0182B	6812N+6066N+0991	6812B+6066B+0182B

*Al momento dell'ordine, indicare su quale lato deve essere installato il pannello laterale fisso.

Laterali su misura

Descrizione	TRASPARENTE		FROST PLUS	
	● NERO	● BIANCO	● NERO	● BIANCO
misura fino 40 cm	1350N+0991	1350B+0182B	1350N+0991+1312	1350B+0182B+1312
misura da 40 fino 80 cm	1334N+0991	1334B+0182B	1334N+0991+1313	1334B+0182B+1313
misura da 80 fino 120 cm	1335N+0991	1335B+0182B	1335N+0991+1315	1335B+0182B+1315

Indicare dove va il laterale fisso. Tempo di consegna 3 settimane. Taglio +32 P.

BASIC COLORE VASCA + laterale fisso 8 mm

PROFILI ORO



PROFILI NICHEL



Laterali fissi vasca

Descrizione	Cm
Laterale fisso BASIC 70x150	67-70
Laterale fisso BASIC 75x150	72-74

TRASPARENTE	
ORO	NICHEL
5065OR	5065NK
5066OR	5066NK

FROST PLUS	
ORO	NICHEL
6065OR	6065NK
6066OR	6066NK

Estensibilità	TRASPARENTE		FROST PLUS	
	ORO	NICHEL	ORO	NICHEL
140-145/67-70	5810OR+5065OR+0182OR	5810NK+5065NK+0182NK	6810OR+6065OR+0182OR	6810NK+6065NK+0182NK
145-150/67-70	5811OR+5065OR+0182OR	5811NK+5065NK+0182NK	6811OR+6065OR+0182OR	6811NK+6065NK+0182NK
150-155/67-70	5812OR+5065OR+0182OR	5812NK+5065NK+0182NK	6812OR+6065OR+0182OR	6812NK+6065NK+0182NK
Estensibilità	TRASPARENTE		FROST PLUS	
	ORO	NICHEL	ORO	NICHEL
140-145/72-74	5810OR+5066OR+0182OR	5810NK+5066NK+0182NK	6810OR+6066OR+0182OR	6810NK+6066NK+0182NK
145-150/72-74	5811OR+5066OR+0182OR	5811NK+5066NK+0182NK	6811OR+6066OR+0182OR	6811NK+6066NK+0182NK
150-155/72-74	5812OR+5066OR+0182OR	5812NK+5066NK+0182NK	6812OR+6066OR+0182OR	6812NK+6066NK+0182NK

*Al momento dell'ordine, indicare su quale lato deve essere installato il pannello laterale fisso.

Lat. fissi su misura

Descrizione	TRASPARENTE		FROST PLUS	
	ORO	NICHEL	ORO	NICHEL
Fina a 40 cm	1350OR+0182OR	1350NK+0182NK	1350OR+0182OR+1312	1350NK+0182NK+1312
Da 40 fino 80 cm	1334OR+0182OR	1334NK+0182NK	1334OR+0182OR+1313	1334NK+0182NK+1313
Da 80 fino 120 cm	1335OR+0182OR	1335NK+0182NK	1335OR+0182OR+1315	1335NK+0182NK+1315

Indicare dove va il laterale fisso. Tempo di consegna 3 settimane.

BASIC COLORE VASCA + laterale fisso 8 mm

PROFILI RAME



PROFILI TITANIO



Laterali fissi vasca

Descrizione	Cm
Laterale fisso BASIC 70x150	67-70
Laterale fisso BASIC 75x150	72-74

TRASPARENTE	
RAME	TITANIO
5065CB	5065T
5066CB	5066T

FROST PLUS	
RAME	TITANIO
6065CB	6065T
6066CB	6066T

Estensibilità	TRASPARENTE		FROST PLUS	
	RAME	TITANIO	RAME	TITANIO
140-145/67-70	5810CB+5065CB+0182CB	5810T+5065T+0182T	6810CB+6065CB+0182CB	6810T+6065T+0182T
145-150/67-70	5811CB+5065CB+0182CB	5811T+5065T+0182T	6811CB+6065CB+0182CB	6811T+6065T+0182T
150-155/67-70	5812CB+5065CB+0182CB	5812T+5065T+0182T	6812CB+6065CB+0182CB	6812T+6065T+0182T
Estensibilità	RAME	TITANIO	RAME	TITANIO
140-145/72-74	5810CB+5066CB+0182CB	5810T+5066T+0182T	6810CB+6066CB+0182CB	6810T+6066T+0182T
145-150/72-74	5811CB+5066CB+0182CB	5811T+5066T+0182T	6811CB+6066CB+0182CB	6811T+6066T+0182T
150-155/72-74	5812CB+5066CB+0182CB	5812T+5066T+0182T	6812CB+6066CB+0182CB	6812T+6066T+0182T

*Al momento dell'ordine, indicare su quale lato deve essere installato il pannello laterale fisso.

Lat. fissi su misura

Descrizione	TRASPARENTE		FROST PLUS	
	RAME	TITANIO	RAME	TITANIO
Fina a 40 cm	1350CB+0182CB	1350T+0182T	1350CB+0182CB+1312	1350T+0182T+1312
Da 40 fino 80 cm	1334CB+0182CB	1334T+0182T	1334CB+0182CB+1313	1334T+0182T+1313
Da 80 fino 120 cm	1335CB+0182CB	1335T+0182T	1335CB+0182CB+1315	1335T+0182T+1315

Indicare dove va il laterale fisso. Tempo di consegna 3 settimane.

BASIC VASCA FREE ANGOLARE



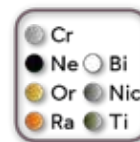
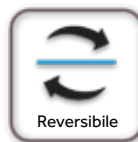
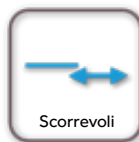

PASSO 1: Selezionare la misura/colore dei PROFILI ANGOLARE

PASSO 2: Selezionare la misura/finitura del VETRO

PASSO 1: PROFILI

Descrizione	CROMO	NERO	BIANCO
	Art.	Art.	Art.
Accessori fino a 120x90 cm	5423+5447	5490+5447N	5580+5447B
Accessori fino a 140x100 cm	5424+5447	5491+5447N	5581+5447B

Descrizione	ORO	NICHEL	RAME	TITANIO
	Art.	Art.	Art.	Art.
Accessori fino a 120x90 cm	5448+5447OR	5463+5447NK	5590+5447CB	5563+5447T
Accessori fino a 140x100 cm	5449+5447OR	5464+5447NK	5591+5447CB	5564+5447T

PASSO 2: VETRO

Estensibilità (Frontale / Lato free)	TRASPARENTE	FROST PLUS
	Art.	Art.
140-145 / 65-100	5050	6050
145-150 / 65-100	5051	6051
150-155 / 65-100	5052	6052
155-160 / 65-100	5053	6053
160-165 / 65-100	5054	6054
165-170 / 65-100	5055	6055

Descrizione	Art.
Profilo espansione +1,5 cm cromo	5429
Profilo espansione +1,5 cm nero	5477
Profilo espansione +1,5 cm bianco	5473
Profilo espansione +1,5 cm oro	5474
Profilo espansione +1,5 cm nicHEL	5475
Profilo espansione +1,5 cm rame	5476
Profilo espansione +1,5 cm titanio	5478



Box doccia su misura e cristalli speciali	TRASPARENTE	FROST PLUS PARSOL / OPACO
Altezza fino 195 cm	+45%	+60%

*Tempo di consegna 3 settimane (maggiori informazioni a pag. 288)

BOX DOCCIA SCORREVOLI SU MISURA E SPECIALI

Futura Temple Basic Twenty

BOX DOCCIA A MISURA TRASPARENTI

- Per calcolare il prezzo incrementare un 45% il prezzo dell'articolo di serie che copre la misura o quella immediatamente superiore.
- Indicare Modello / Articolo / Misura.
- Non si accettano misure superiori alla massima del listino, eccetto Basic fino 220 cm di altezza.

Art. 0868

+45%

ALTEZZA 195 cm

SOLO MODELLO BASIC CROMO

Art. 0871

+75%

ALTEZZA 196 a 220 cm

BOX DOCCIA SU MISURA CRISTALLI SPECIALI

Finitura **FROST PLUS ACIDO, PARSOL, CARGLASS / OPACO**

- Per calcolare il prezzo incrementare un 60% il prezzo dell'articolo di serie che copre la misura o quella immediatamente superiore.
- E' necessario indicare la posizione della porta e del fisso.
- Indicare Modello /Articolo/ Misura.
- Non si accettano misure superiori alla massima del listino, eccetto Basic fino 220 cm di altezza.

Art. 0870

+60%

ALTEZZA 195 cm

SOLO MODELLO BASIC CROMO

Art. 0872

+90%

ALTEZZA 196 a 220 cm

FINITURE CRISTALLI SPECIALI:



FROST PLUS



PARSOL BRONZO



PARSOL FUMÉ



OPACO

TEMPO DI CONSEGNA 20 GIORNI (Non si accettano resi e annullazioni di cristalli su misura)

BOX DOCCIA A BATTENTE SU MISURA

Glass Open Glass Pieghevole

PANNELLI FISSI

MODELLO	Larghezza < 40 cm	Larghezza > 40 e < 80 cm	Larghezza > 80 e < 120 cm
	Art.	Art.	Art.
FISSO OPEN 6 mm	1345	1316	1317
FISSO OPEN NERO 6 mm	1345N	1316N	1317N
FISSO GLASS 8 mm CROMO	1339	1336	1337
FISSO GLASS 8 mm NERO	1339N	1336N	1337N
FISSO GLASS 8 mm BIANCO	1339BL	1336BL	1337BL
FISSO GLASS 8 mm ORO	1339OR	1336OR	1337OR
FISSO GLASS 8 mm RAME	1339CB	1336CB	1337CB
FISSO GLASS 8 mm NICHEL	1339NK	1336NK	1337NK
FISSO GLASS 8 mm TITANIO	1339T	1336T	1337T

Include profili e ferramenta.

GLASS PIEGHEVOLE

MODELLO	Larghezza < 80 cm
	Art.
PORTA GLASS PIEGHEVOLE 6 mm	1338

PORTA GLASS CON CERNIERA A PARETE

FINITURA	Larghezza < 80 cm
	Art.
PORTA GLASS 6 mm CROMO	1338CR
PORTA GLASS 6 mm NERO	1338N
PORTA GLASS 6 mm BIANCO	1338BL
PORTA GLASS 6 mm ORO	1338OR
PORTA GLASS 6 mm RAME	1338CB
PORTA GLASS 6 mm NICHEL	1338NK
PORTA GLASS 6 mm TITANIO	1338T

Include porta personalizzata e ferramenta per l'installazione di cerniere a muro.

Porta GLASS CON CERNIERA A FISSO

FINITURA	Larghezza < 80 cm
	Art.
PORTA GLASS 6 mm CROMO	1385CR
PORTA GLASS 6 mm NERO	1385N
PORTA GLASS 6 mm BIANCO	1385BL
PORTA GLASS 6 mm ORO	1385OR
PORTA GLASS 6 mm RAME	1385CB
PORTA GLASS 6 mm NICHEL	1385NK
PORTA GLASS 6 mm TITANIO	1385T

Include porta personalizzata e ferramenta per l'installazione di cerniere fisse in vetro.

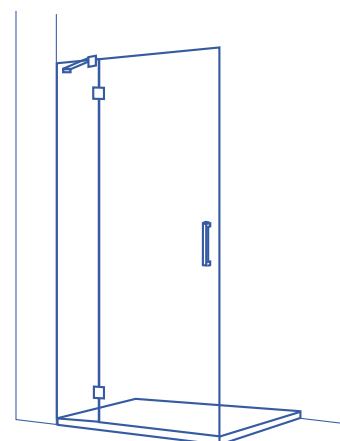
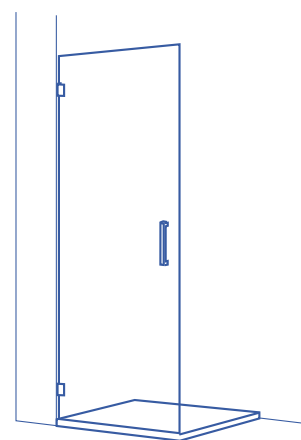

LATERALI FISSI SU MISURA

MODELLO	Larghezza <40 cm	Larghezza >40 e <80	Larghezza >80 e <120
	Art.	Art.	Art.
Laterale fisso 8 mm VETRUM	1340	1300	1306
Laterale fisso 8 mm MOVING	1341	1301	1307
Laterale fisso 8 mm TEMPLE	1349	1302	1308
Laterale fisso 6 mm BYPASS	1346	1318	1319
Laterale fisso 8 mm FUTURA	1347	1330	1331
*Fisso STD 8 mm AKTUAL / PRESTIGE / AKORD/OPEN/GLASS/ GLASS PIEGHEVOLE	1343	1304	1310
*Fisso STD NERO 8 mm	1343N	1304N	1310N

*Non include il braccetto

Aumento per finitura FROST PLUS	1312	1313	1315
---------------------------------	------	------	------

*Indicare posizione del laterale

Aumento per finitura PARSOL	Art. 0870SC - Laterali fissi su misura +35%
-----------------------------	--

LATERALE FISSO ALTEZZA SPECIALE BASIC 195 A 220 (SOLO CROMO)

MODELLO	Art.	Art.	Art.
Laterale fisso 8 mm BASIC 195 fino 220 cm	1350H2	1334H2	1335H2

TAGLIO

Art.: 0862 | Descrizione: Taglio quadrato

*Eccetto Vetrum, Kenna, Prestige titan, Aktual, Glass pieghevole e Bypass.

(misura totale incluso il profilo)

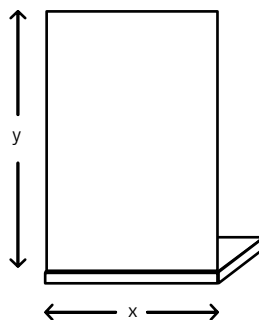



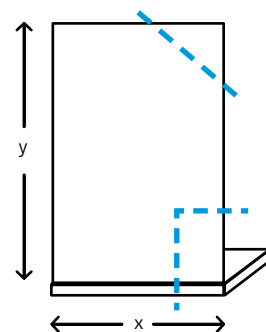











Nel caso di taglio ad incastro, indicare posizione





TEMPO DI CONSEGNA 20 GIORNI (Non si accettano resi e annullazioni di cristalli su misura)

LATERALI FISSI SU MISURA



BASIC	 CROMO	 NERO	 BIANCO	
Larghezza <40 cm	1350	1350N	1350B	
Larghezza >40 e <80 cm	1334	1334N	1334B	
Larghezza >80 e <120 cm	1335	1335N	1335B	
BASIC	 ORO	 RAME	 NICHEL	 TITANIO
Larghezza <40 cm	1350OR	1350CB	1350NK	1350T
Larghezza >40 e <80 cm	1334OR	1334CB	1334NK	1334T
Larghezza >80 e <120 cm	1335OR	1335CB	1335NK	1335T





GLASS/OPEN	 CROMO	 NERO	 BIANCO	
Larghezza <40 cm	1345	1345N	1345B	
Larghezza >40 e <80 cm	1316	1316N	1316B	
Larghezza >80 e <120 cm	1317	1317N	1317B	
GLASS/OPEN	 ORO	 RAME	 NICHEL	 TITANIO
Larghezza <40 cm	1345OR	1345CB	1345NK	1345T
Larghezza >40 e <80 cm	1316OR	1316CB	1316NK	1316T
Larghezza >80 e <120 cm	1317OR	1317CB	1317NK	1317T



*Non include il braccetto

GLASS PIEGHEVOLE	 CROMO	 NERO
Larghezza <40 cm	1380	1380N
Larghezza >40 e <80 cm	1381	1381N
Larghezza >80 e <120 cm	1382	1382N

*Non include il braccetto

TRIO	 CROMO	 NERO
Larghezza <40 cm	1342	1342N
Larghezza >40 e <80 cm	1303	1303N
Larghezza >80 e <120 cm	1309	1309N

TWENTY	 CROMO	 NERO
Larghezza <40 cm	1375	1375N
Larghezza >40 e <80 cm	1376	1376N
Larghezza >80 e <120 cm	1377	1377N
TWENTY	 ORO	 RAME
Larghezza <40 cm	1375OR	1375CB
Larghezza >40 e <80 cm	1376OR	1376CB
Larghezza >80 e <120 cm	1377OR	1377CB

KENNA	 CROMO	 NERO	 ORO
Larghezza <40 cm	1365	1365N	1365OR
Larghezza >40 e <80 cm	1366	1366N	1366OR
Larghezza >80 e <120 cm	1367	1367N	1367OR

FISSI SCREEN SU MISURA

(TEMPO DI CONSEGNA 3 SETTIMANE)

Descrizione	CROMO	NERO	BIANCO	
Larghezza < 80 cm Altezza fino 195 cm	1305	1305N	1305B	
Larghezza 80 a 120 cm Altezza fino 195 cm	1311	1311N	1311B	
Descrizione	ORO	RAME	NICHEL	TITANIO
Larghezza < 80 cm Altezza fino 195 cm	1305OR	1305CB	1305NK	1305T
Larghezza 80 a 120 cm Altezza fino 195 cm	1311OR	1311CB	1311NK	1311T

Questi prezzi includono tutti i componenti per l'assemblaggio, tranne il braccio del modello Screen.

FINITURA FROST PLUS

Descrizione	Art.	Descrizione	Art.
Aumento FROST PLUS larghezza <80 cm	1313	Aumento FROST PLUS larghezza 80-120 cm	1315

ALTEZZA XXL SOLO CROMO

Descrizione	Art.
Larghezza < 80 cm Altezza da 195 fino 220 cm	1363
Larghezza 80 a 120 cm Altezza da 195 fino 220 cm	1364

*Include braccetto

TAGLIO

Descrizione	Art.
Taglio quadrato/taglio	0862

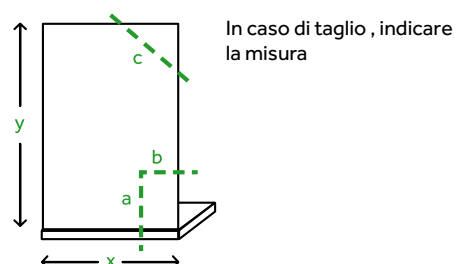

FINITURE PARSOL IN SCREEN/LATERALI FISSI SU MISURA 8 mm

Art. 0870SC - Screen su misura +35%



FROST PLUS



PARSOL BRONCE



PARSOL FUMÉ



OPACO

TEMPO DI CONSEGNA 20 GIORNI (Non si accettano resi e annullazioni di cristalli su misura)

SCREEN CERNIERE MOBILI 180° SU MISURA

(TEMPO DI CONSEGNA 3 SETTIMANE)

Descrizione	CROMO	NERO	BIANCO	
Larghezza < 40 cm Altezza fino 195 cm	1355	1355N	1355B	
Da 40 fino 80 cm Altezza fino 195 cm	1356	1356N	1356B	
Descrizione	ORO	RAME	NICHEL	TITANIO
Larghezza < 80 cm Altezza fino 195 cm	1355OR	1355CB	1355NK	1355T
Larghezza < 80 cm Altezza fino 195 cm	1356OR	1356CB	1356NK	1356T

Questi prezzi includono tutti i componenti (ferramenta e cerniere) per il montaggio.

FINITURA FROST PLUS

Descrizione	Art.
Aumento FROST PLUS larghezza < 80 cm	1313

ALTEZZA XXL SOLO CROMO

Descrizione	Art.
Larghezza < 80 cm Altezza da 195 fino 220 cm	1355H2

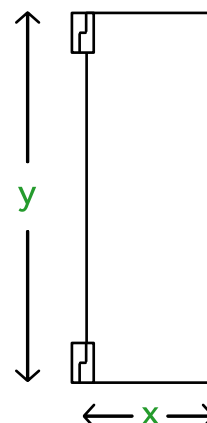

KITS PROFILI E ACCESSORI SCREEN

KIT PROFILO + BRACCETTO SCREEN

CROMO	NERO	BIANCO	
5184	5185	5183	
ORO	RAME	NICHEL	TITANIO
5186	5188	5189	5187

Questi kit sono già inclusi nei riferimenti delle tabelle precedenti.

CERNIERE MOBILI 180°

CROMO	NERO	BIANCO	
0330	0330NG	0330BL	
ORO	RAME	NICHEL	TITANIO
0330OR	0330CB	0330NK	0330T



Questi kits sono già inclusi nei riferimenti delle tabelle precedenti.





TEMPO DI CONSEGNA 20 GIORNI (Non si accettano resi e annullazioni di cristalli su misura)

TUBI COMPENSAZIONE MONTAGGIO (INCLUDE COPERCHIO E FERRAMENTA)

Descrizione	Art.
Tubo compensazione 40x20x2000 mm cromo	0001
Tubo compensazione 40x40x2000 mm cromo	0002
Tubo compensazione 40x40x2000 mm nero opaco	0002N
Tubo compensazione 40x40x2000 mm bianco	0002B
Tubo compensazione 40x40x2000 mm oro	0002OR
Tubo compensazione 40x40x2000 mm rame	0002CB
Tubo compensazione 40x40x2000 mm nichel	0002NK
Tubo compensazione 40x40x2000 mm titanio	0002T
Tubo compensazione 40x60x2000 mm cromo	0003
Angolare 30x30x2000 mm cromo	0004
Tubo compensazione INOX 40x20x2000 mm	0009
Tubo compensazione INOX 40x40x2000 mm	0010

PROFILI E ACCESSORI PER LATI FISSI SU MISURA

Descrizione	 CROMO	 NERO	 BIANCO
Fissi STD	0821	9023	-
Trio	0006	0006N	-
Spazio fino 90cm	0825	0825N	-
Spazio fino 120cm	0826	0826N	-
Moving	1081	-	-
Vetrum	1080	-	-
Futura	5328	-	-
Temple	5128	-	-
Bypass	1277	-	-
Basic	5528	5492	5588
Twenty	2025	2026	-
Kenna	6564	6564N	-

Descrizione	 ORO	 RAME	 NICHEL	 TITANIO
Basic	5445	5597	5469	5567
Kenna	6564OR	-	-	-
Twenty	2027	2028	-	-

*Include tutto tranne il vetro

OPZIONI PER BOX DOCCIA



ART. 1731 / 1732 MANIGLIA ULTRAPIATTA: Aumenta 7 cm il passaggio di entrata in misure intermedie e 2 cm nel resto.



ART. 1221 MAGNETE DI ESPANSIONE +1,2 OPEN: coppia di calamite magnetiche 1,2 cm. più larghe che permettono aumentare l'estensibilità della combinazione di 1,2 cm.



ART. 1072 OPZIONE GUARNIZIONE DEL PROFILO + GUARNIZIONE A BOLLE D'ARIA: Sistema di chiusura con profilo ad "U" a parete e guarnizione di tenuta sulla porta scorrevole.



ART. 0007 ADORNO IN ALLUMINIO TRIO/BASIC: Piastrina in alluminio lucido per coprire lo spazio tra il limite del piatto ed il profilo di chiusura del Box doccia. Si usa quando il rivestimento ceramico esterno è diverso dall'interno del Box Doccia. Dimensioni 195x3,8 cm.



ART. 0008 ADORNO ACCIAIO FUTURA/ROTARY/TEMPLE: Piastrina in acciaio lucido per coprire lo spazio tra il limite del piatto ed il profilo di chiusura del Box doccia. Si usa quando il rivestimento ceramico esterno è diverso dall'interno del Box Doccia. Dimensioni 195x3,8 cm.



ART. 1222 PROFILO DI ESPANSIONE PORTA OPEN: Si usa come compensatore del profilo delle porte Open. L'art. 1222 rende anche possibile l'unione del profilo della porta al laterale fisso STD.



ART. 1215 Profilo porta OPEN: sostituendo il profilo 1211 con questo profilo, si riduce fino a 1 cm. l'estensibilità della combinazione.

ART. 1075 PROFILO DELL'UNIONE FISSO+LATERAL FISSO: Su Vetrum e Moving Nella Vetrum e Moving permette l'installazione del laterale fisso al fisso del frontale collocato al posto della porta (foto).Valido solo per i laterali fissi su misura; applicato ad un laterale fisso di serie, si perderanno 5 cm. di estensibilità. Nella Temple/Rotary/Basic non cambia ne l'articolo ne l'estensibilità della combinazione porta-fisso, e per questo si dovrà indicare nell'ordine la posizione dove si installerà il fisso.

RICAMBI BOX DOCCIA

Nel seguente codice QR incontrate gli esplosi dei diversi formati dei nostri box doccia, separati per modello, per facilitare l'identificazione del ricambio.



GME BASIC TITANIO

FIUO-CORRIERERA **FRONTALE-LAZE FIUO**

2FIUO-2CORRIERERAS **FREE**

FIUO-CORRIERERAS-FIUO **ANGULAR AL VERTICE**

REPUESTOS

GME BASIC TITANIO 1F+1C

Ref.	Imagen	Q	Ref.	Imagen	Q	Ref.	Imagen	Q	Ref.	Imagen	Q
8400		8	8401		8	8402		8	8403		8
8404		8	8405		8	8406		8	8407		8
8408		8	8409		8	8410		8	8411		8
8412		8	8413		8	8414		8	8415		8

REPUESTOS

GME BASIC TITANIO SPAZIO 2F+2C

Ref.	Imagen	Q	Ref.	Imagen	Q	Ref.	Imagen	Q	Ref.	Imagen	Q
8420		8	8421		8	8422		8	8423		8
8424		8	8425		8	8426		8	8427		8
8428		8	8429		8	8430		8	8431		8
8432		8	8433		8	8434		8	8435		8

REPUESTOS

GME BASIC TITANIO

BASIC 1F+1C + LAZE FIUO **BASIC 1F+1C FREE**

A **B**

Ref.	Imagen	Q	Ref.	Imagen	Q	Ref.	Imagen	Q
8440		8	8441		8	8442		8
8443		8	8444		8	8445		8
8446		8	8447		8	8448		8
8449		8	8450		8	8451		8

REPUESTOS

GME BASIC TITANIO ANGULAR 2F+2C

Ref.	Imagen	Q	Ref.	Imagen	Q	Ref.	Imagen	Q	Ref.	Imagen	Q
8460		8	8461		8	8462		8	8463		8
8464		8	8465		8	8466		8	8467		8
8468		8	8469		8	8470		8	8471		8
8472		8	8473		8	8474		8	8475		8

REPUESTOS

GME BASIC CRISTALES FIUOS Y CORRIERERAS

Modelo	INSTRUMENTE				CORRIERAS			
	Q	Ref.	Q	Ref.	Q	Ref.	Q	Ref.
BASIC 1F+1C	8	8400	8	8401	8	8402	8	8403
BASIC 1F+1C FREE	8	8440	8	8441	8	8442	8	8443
BASIC 1F+1C LAZE FIUO	8	8440	8	8441	8	8442	8	8443
BASIC 1F+1C ANGULAR	8	8460	8	8461	8	8462	8	8463
BASIC 2F+2C	8	8420	8	8421	8	8422	8	8423
BASIC 2F+2C SPAZIO	8	8420	8	8421	8	8422	8	8423
BASIC 2F+2C ANGULAR	8	8460	8	8461	8	8462	8	8463
BASIC 2F+2C FREE	8	8440	8	8441	8	8442	8	8443
BASIC 2F+2C LAZE FIUO	8	8440	8	8441	8	8442	8	8443
BASIC 2F+2C ANGULAR FREE	8	8460	8	8461	8	8462	8	8463
BASIC 2F+2C ANGULAR LAZE FIUO	8	8460	8	8461	8	8462	8	8463
BASIC 2F+2C ANGULAR FREE LAZE FIUO	8	8460	8	8461	8	8462	8	8463

REPUESTOS

MISURE E PREZZI DEI PROFILI (cm)

PROFILI VERTICALI A PARETE DEL FISSO

AKTUAL / PRESTIGE AKORD/GLASS	VETRUM	MOVING	FUTURA / TEMPLE	BASIC	OPEN/GLASS SPAZIO	KENNA
PA3F / PA3U	VE12	MO17	FTR3	B03C*	OP4C*	K040
TWENTY	SCREEN CROMO	GLASS				
TW30C*	S01C*	G014C* / G015C*				

PROFILI VERTICALI A PARETE CHIUSURA PORTA





VETRUM MOVING	FUTURA	BASIC TEMPLE	OPEN GLASS	TRIO	BYPASS	PRESTIGE	KENNA
VE11	F007	B07C*	R195C*	TR20* / TR19*	BY12	PA05	K040*

PROFILI ORIZZONTALI SUPERIORI





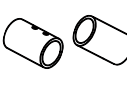

TEMPLE	BASIC	FUTURA	BYPASS	TRIO	
Altezza 4,2 Larghezza 1,3	Altezza 4,8 Larghezza 2,3	Altezza 2,5 Larghezza 3,1	Altezza 4 Larghezza 6	Altezza 5,7 Larghezza 5,7	
TE21C180	B21C*210	F21C210	BY74	TR246*	
AKTUAL PRESTIGE	MOVING	TWENTY	SPAZIO	PORTE DIVISORIE	
Altezza 4,5 Larghezza 2	Ø2,5	Altezza 2 Larghezza 3,1	Altezza 4 Larghezza 2,5		
A599	MO180	TW190C*	SP02C*	PP85C*	PP8C*

*Se il ricambio è di un modello disponibile in più colori, allegare il codice corrispondente al colore:
C - CROMO | **N** - NERO | **B** - BIANCO | **O** - ORO | **CB** - RAME | **NK** - NICHEL | **T** - TITANIO

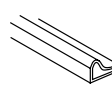
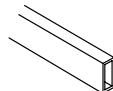

SUPPORTI A PARETE

TEMPLE	BASIC	FUTURA	MOVING	BYPASS	TRIO
					
Altezza 5,4 Larghezza 3,8	Altezza 5,8 Larghezza 5,2	Altezza 3,5 Larghezza 6	Ø3	Altezza 5,4 Larghezza 7	Altezza 6,2 Larghezza 6,6
TE14	B15C*	F15	MO09	BY09	TR8*

PROFILI ORIZZONTALI INFERIORI (SALVA GOCCIA METALLICI)

FUTURA/TEMPLE BASIC/GLASS	MOVING	BYPASS	TRIO	AKTUAL	VETRUM	OPEN	GLASS PIEGHEVOLE
							
1x0,6 cm	0,9x0,9 cm	1,6x1,1 cm	1,1x1 cm	0,8x1,2 cm	1,8x0,8 cm	0,6x0,6 cm	1x0,5 cm
B12C*210	MO15	BY07	TR1395*	A011	VE08	OP6C*	GP08*

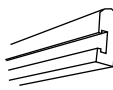

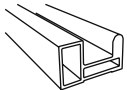
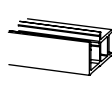

PROFILI ORIZZONTALI INFERIORI

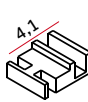
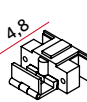
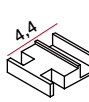
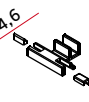
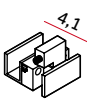
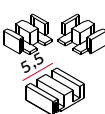
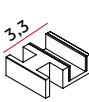
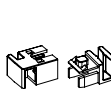
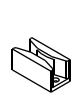
VITRO	TWENTY (frontal)	TWENTY (vértice e 2f+2c)	KENNA
			
1x2,3 cm	1,6x0,9 cm	1,6x0,9 cm	1,6x2,9 cm
VI14 210	TW2C*	TW44C*	K120*

GUIDE INFERIORI

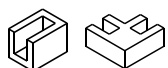
FUTURA	TEMPLE BASIC	MOVING	AKTUAL	VETRUM	BYPASS	TRIO	TWENTY	porta. DIVIS.
								
F011	G10C*	MO14	A009	VE07	BY5 / BY08	TR12*	TW14C* / TW15C*	PP9C*

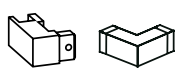

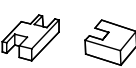
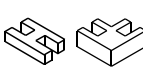
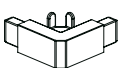
ANGOLARI INFERIORI

FUTURA TEMPLE/BASIC	MOVING	VETRUM	TRIO	OPEN	GLASS	TWENTY
						
B29C* / B42C*	MO22	VE44 / VE90	TR37*	OP3C*	G009* / G011*	TW43C*



*Se il ricambio è di un modello disponibile in più colori, allegare il codice corrispondente al colore:
C - CROMO | **N** - NERO | **B** - BIANCO | **O** - ORO | **CB** - RAME | **NK** - NICHEL | **T** - TITANIO

GUARNIZIONI





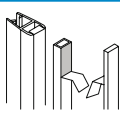

GUARNIZIONI DI CHIUSURA A PALLONCINO

FUTURA/TEMPLE/BASIC	TRIO	SPAZIO
		
B006	TR16	SP13*







GUARNIZIONI MAGNETICHE ADESIVE

FUTURA/TEMPLE/BASIC/TRIO	KENNA	SPAZIO
		
B027 / B66C* / B65C*	K220	SP12*









GUARNIZIONI MAGNETICHE

FUTURA / TEMPLE BASIC	VETRUM	MOVING	AKTUAL /PRESTIGE	OPEN / GLASS	KENNA	TWENTY
						
B036	VE14	MO20	A017 / A007	OP2C*	K180	TW10







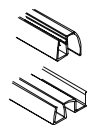

GUARNIZIONI VERTICALI

FUTURA /TEMPLE BASIC/GLASS/TWENTY	VETRUM	MOVING	AKTUAL/PRESTIGE	AKORD	KENNA	
			 8/6mm			
B005	VE19	MO19	A006 / A008	AK06	K070	K080



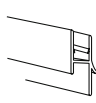



GUARNIZIONI A PRESSIONE

FUTURA TEMPLE / BASIC	VETRUM	MOVING	AKTUAL	SCREEN	OPEN/ GLASS	KENNA	TWENTY	SPAZIO
								
B004	VE15	MO18	A013	S002	OP05	K050	TW08	SP19

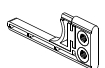



GUARNIZIONI INFERIORI

FUTURA TEMPLE / BASIC	TRIO	TWENTY	AKTUAL	BYPASS	OPEN GLASS	PANEL OPEN	PANEL GLASS	KENNA
								
B011	TR28 / TR11	TW41	A010	BY06	OP07	GB06	G012	K150

FRENI PORTA





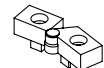

FUTURA	TEMPLE	MOVING	BASIC	AKTUAL PRESTIGE	KENNA	TWENTY	porta. DIVIS.
						 SOFT CLOSE	
F019	TE15	M010	B22C*	PA1	K290	TW28	PP11

CERNIERE



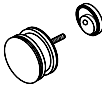

GLASS	GLASS	GLASS PIEGHEVOLE	SCREEN CERNIERA	SCREEN/OPEN	AKORD
					
HG07*	G16C*	HM03*	S31C*	HU01C*	AK21

*Se il ricambio è di un modello disponibile in più colori, allegare il codice corrispondente al colore:
C - CROMO | **N** - NERO | **B** - BIANCO | **O** - ORO | **CB** - RAME | **NK** - NICHEL | **T** - TITANIO



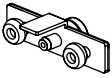

CUSCINETTI (PREZZO PER UNITÀ)

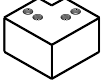

FUTURA	TEMPLE	VETRUM	MOVING	BASIC	SPAZIO	AKTUAL
						
F014	TE13	VE10	MO12	B013	SP06C*	A016

CUSCINETTI (PREZZO PER UNITÀ)

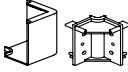

KENNA	TWENTY	PRESTIGE	AKORD	BYPASS	porta. da PASSO	
						
K300*	TW25C*	TW45C*	P010 / P007	AK19	BY11	PP04

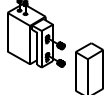
ANGOLARI SUPERIORI (ENTRATA AD ANGOLO)

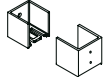



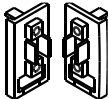
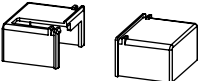
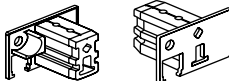

FUTURA	TEMPLE	MOVING	BASIC	TWENTY	AKTUAL PRESTIGE
					
F022	TE25	MO23	B25C*	TW27C*	PA 17 / PA16

TEMPLE	BASIC	BYPASS	TRIO
			
TE44 / TE31	B44C* / B31C*	BY16	TR8*

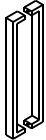
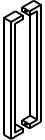
FERMI GUIDA (P PER UNITÀ)

AKTUAL / PRESTIGE	KENNA	TWENTY	porta. da PASSO
			
PA02	K09	TW24C*	PP10C*

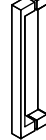
MANIGLIE

TEMPLE / BASIC / FUTURA GLASS / AKTUAL / PRESTIGE	MOVING	VETRUM	BYPASS	TRIO	KENNA	TWENTY	porta. DE PASSO	OPEN
								
22x2,5 cm	21x4 cm	42x2 cm	22x1 cm	28x3 cm	22x4,5 cm	22,5x3 cm		28x3 cm
T22C*	MO13	VE06	BY04	T28C*	K200*	TW29C*	PP6C*	T28C*

*Se il ricambio è di un modello disponibile in più colori, allegare il codice corrispondente al colore:
C - CROMO | **N** - NERO | **B** - BIANCO | **O** - ORO | **CB** - RAME | **NK** - NICHEL | **T** - TITANIO

RICAMBI	OPEN	OPEN FROST	OPEN NERA	GLASS PIEGHEVOLE
Cristallo fisso da 20				
Cristallo fisso da 25				
Cristallo fisso da 30				
Cristallo fisso da 40				
Cristallo fisso da 50				
Cristallo fisso da 60				
Porta da 30				
Porta da 35				
Porta da 40				
Porta da 45				
Porta da 50				
Porta da 55				
Porta da 60				
Porta da 65				
Porta da 70				
Porta da 75				
Porta da 80				
Porta da 85				

RICAMBI TRIO	FISSO	INTERM.	PORTA
Frontale da 90			
Frontale da 95			
Frontale da 100			
Frontale da 105			
Frontale da 110			
Frontale da 115			
Frontale da 120			
Frontale da 125			
Frontale da 130			
Frontale da 135			
Frontale da 140			
Frontale da 145			
Frontale da 150			
Frontale da 155			
Frontale da 160			
Cuscinetto Trio			

RICAMBI BYPASS

Porta Bypass 120
Porta Bypass 130
Porta Bypass 140
Porta Bypass 150
Porta Bypass 160

	VETRUM	MOVING	AKTUAL		PRESTIGE	
	TRASP	TRASP	TRASP	F. PLUS	TRASP	F. PLUS
Cristallo fisso lato da 70						
Cristallo fisso lato da 75						
Cristallo fisso lato da 80						
Cristallo fisso lato da 90						
Cristallo fisso lato da 100						
Cristallo fisso lato da 110						
Cristallo fisso lato da 120						
Cristallo fisso lato da 130						
Cristallo fisso lato da 140						
Cristallo fisso lato da 150						
Cristallo fisso lato da 160						
Cristallo fisso lato da 170						
Cristallo fisso lato da 180						
Scorrevoli lato da 70						
Scorrevoli lato da 75						
Scorrevoli lato da 80						
Scorrevoli lato da 90						
Scorrevoli lato da 100						
Scorrevoli lato da 110						
Scorrevoli lato da 120						
Scorrevoli lato da 130						
Scorrevoli lato da 140						
Scorrevoli lato da 150						
Scorrevoli lato da 160						
Scorrevoli lato da 170						
Scorrevoli lato da 180						
Cristallo laterale fisso 70						
Cristallo laterale fisso 75						
Cristallo laterale fisso 80						
Cristallo laterale fisso 90						

**RICAMBI
PANNELLI vasca**

Cerniera Glass (1 uni)
Braccetto supporto vasca Open
Cristallo fisso Open vasca
Porta Open vasca
Cerniera Open

RIC. SCREEN CR

Guarnizione verticale
Guarnizione inferiore
Profilo a parete
Profilo angolo
Cerniera sup/inf moving
Pinza braccetti

BRACCETTI

Vetrum braccetto laterale
Vetrum braccetto frontale
Open
Glass
Kenna braccetto frontale
Kenna braccetto laterale

È NECESSARIO INDICARE MODELLO E ARTICOLO DEL BOX DOCCIA
PER EVADERE UN ORDINE DI QUALSIASI RICAMBIO

DETTAGLIO P/ARTICOLI SERIE BASIC VASCA

FISSO + PORTA

	TRASPARENTE	FROST PLUS
	Art.	Art.
Cristallo fisso+porta 140-145 vasca	5050	6050
Cristallo fisso+porta 145-150 vasca	5051	6051
Cristallo fisso+porta 150-155 vasca	5052	6052
Cristallo fisso+porta 155-160 vasca	5053	6053
Cristallo fisso+porta 160-165 vasca	5054	6054
Cristallo fisso+porta 165-170 vasca	5055	6055
Cristalli 2F+2S fissi+porta 80-85 vasca	5060	6060
Cristalli 2F+2S fissi+porta 85-90 vasca	5062	6062
Cristalli 2F+2S fissi+porta 90-95 vasca	5061	6061

FISSI

	TRASPARENTE	FROST PLUS
	Art.	Art.
Cristallo fisso frontale vasca 5050 (71,5cm)	F5050	F6050
Cristallo fisso frontale vasca 5051 (71,5cm)	F5051	F6051
Cristallo fisso frontale vasca 5052 (76,5cm)	F5052	F6052
Cristallo fisso frontale vasca 5053 (76,5cm)	F5053	F6053
Cristallo fisso frontale vasca 5054 (86,5cm)	F5054	F6054
Cristallo fisso frontale vasca 5055 (86,5cm)	F5055	F6055
Cristallo fisso frontale vasca 5060 (39,6cm)	F5060	F6060
Cristallo fisso frontale vasca 5062 (39,6cm)	F5062	F6062
Cristallo fisso frontale vasca 5061 (44,6cm)	F5061	F6061

PORTE

	TRASPARENTE	FROST PLUS
	Art.	Art.
Cristallo porta frontale vasca 5050 (72,3cm)	P5050	P6050
Cristallo porta frontale vasca 5051 (77,3cm)	P5051	P6051
Cristallo porta frontale vasca 5052 (77,3cm)	P5052	P6052
Cristallo porta frontale vasca 5053 (82,3cm)	P5053	P6053
Cristallo porta frontale vasca 5054 (77,3cm)	P5054	P6054
Cristallo porta frontale vasca 5055 (82,3cm)	P5055	P6055
Cristallo porta frontale vasca 5060 (40,4cm)	P5060	P6060
Cristallo porta frontale vasca 5062 (45,4cm)	P5062	P6062
Cristallo porta frontale vasca 5061 (45,4cm)	P5061	P6061

BASIC PROFILI E ACCESSORI CROMO

	Art.
KIT 1F+1S fino 180 cm	5458
KIT 2F+2S fino 182 cm	5459

DETTAGLIO P/ARTICOLI

SERIE BASIC/FUTURA/TEMPLE/SCREEN

Fisso + Porta

	TRASPARENTE	FROST PLUS
	Art.	Art.
Cristallo fisso + Porta lato da 65-70	5018	6018
Cristallo fisso + Porta lato da 70-75	5029	6029
Cristallo fisso + Porta lato da 75-80	5019	6019
Cristallo fisso + Porta lato da 80-85	5030	6030
Cristallo fisso + Porta lato da 85-90	5020	6020
Cristallo fisso + Porta lato da 90-95	5031	6031
Cristallo fisso + Porta lato da 95-100	5021	6021
Cristallo fisso + Porta lato da 115-120	5022	6022
Cristallo fisso + Porta frontale da 95-100	5001	6001
Cristallo fisso + Porta frontale da 100-105	5002	6002
Cristallo fisso + Porta frontale da 105-110	5003	6003
Cristallo fisso + Porta frontale da 110-115	5004	6004
Cristallo fisso + Porta frontale da 115-120	5005	6005
Cristallo fisso + Porta frontale da 120-125	5006	6006
Cristallo fisso + Porta frontale da 125-130	5007	6007
Cristallo fisso + Porta frontale da 130-135	5008	6008
Cristallo fisso + Porta frontale da 135-140	5009	6009
Cristallo fisso + Porta frontale da 140-145	5010	6010
Cristallo fisso + Porta frontale da 145-150	5011	6011
Cristallo fisso + Porta frontale da 150-155	5012	6012
Cristallo fisso + Porta frontale da 155-160	5013	6013
Cristallo fisso + Porta frontale da 160-165	5014	6014
Cristallo fisso + Porta frontale da 165-170	5015L	6015L
Cristallo fisso + Porta frontale da 170-175	5016L	6016L
Cristallo fisso + Porta frontale da 175-180	5017L	6017L
Cristallo fisso + Porta frontale da 180-190	5023L	6023L
Cristallo fisso + Porta frontale da 190-200	5024L	6024L

CRISTALLI LAT. FISSI E SCREEN

Laterale fisso da 70	5025	6025
Laterale fisso da 75	5057	6057
Laterale fisso da 80	5026	6026
Laterale fisso da 90	5027	6027
Laterale fisso da 100	5033	6033
Laterale fisso da 110	5034	6034
Laterale fisso da 120	5035	6035

BASIC PROFILI E ACCESSORI

	CROMO	NERO	BIANCA	ORO	NICHEL	RAME	TITANIO
	Art.	Art.	Art.	Art.	Art.	Art.	Art.
KIT angolare 120X90	5423	5490	5580	5448	5463	5590	5563
KIT angolare 140X100	5424	5491	5581	5449	5464	5591	5564
KIT 1F+1S fino 140	5434	5493	5583	5440	5460	5592	5560
KIT 1F+1S fino 180	5438	5494	5584	5441	5461	5593	5561
KIT 1F+1S fino 200	5446	5495	5585	5442	5462	5594	5562
KIT 2F+2S fino 172	5451	5496	5586	5498	5465	5595	5565
KIT 2F+2S fino 210	5454	5497	5587	5499	5466	5596	5566
KIT laterale fisso	5444	5492	5588	5445	5469	5597	5567

FISSI (vetro singolo)

	TRASPARENTE	FROST PLUS
	Art.	Art.
Cristallo fisso lato 5018 (29,6cm)	5018F	6018F
Cristallo fisso lato 5029 (34,6cm)	5029F	6029F
Cristallo fisso lato 5019 (34,6cm)	5019F	6019F
Cristallo fisso lato 5030 (39,6cm)	5030F	6030F
Cristallo fisso lato 5020 (39,6cm)	5020F	6020F
Cristallo fisso lato 5031 (44,6cm)	5031F	6031F
Cristallo fisso lato 5021 (44,6cm)	5021F	6021F
Cristallo fisso lato 5022 (54,6cm)	5022F	6022F
Cristallo fisso frontale 5001 (46,5cm)	5001F	6001F
Cristallo fisso frontale 5002 (51,5cm)	5002F	6002F
Cristallo fisso frontale 5003 (51,5cm)	5003F	6003F
Cristallo fisso frontale 5004 (56,5cm)	5004F	6004F
Cristallo fisso frontale 5005 (56,5cm)	5005F	6005F
Cristallo fisso frontale 5006 (61,5cm)	5006F	6006F
Cristallo fisso frontale 5007 (61,5cm)	5007F	6007F
Cristallo fisso frontale 5008 (66,5cm)	5008F	6008F
Cristallo fisso frontale 5009 (66,5cm)	5009F	6009F
Cristallo fisso frontale 5010 (71,5cm)	5010F	6010F
Cristallo fisso frontale 5011 (71,5cm)	5011F	6011F
Cristallo fisso frontale 5012 (76,5cm)	5012F	6012F
Cristallo fisso frontale 5013 (76,5cm)	5013F	6013F
Cristallo fisso frontale 5014 (86,5cm)	5014F	6014F
Cristallo fisso frontale 5015 (86,5cm)	5015F	6015F
Cristallo fisso frontale 5016 (91,5cm)	5016F	6016F
Cristallo fisso frontale 5017 (96,5cm)	5017F	6017F
Cristallo fisso frontale 5023 (106,5cm)	5023F	6023F
Cristallo fisso frontale 5024 (116,5cm)	5024F	6024F

PORTE (vetro singolo)

	TRASPARENTE	FROST PLUS
	Art.	Art.
Cristallo porta lato 5018 (35,4cm)	P5018	P6018
Cristallo porta lato 5029 (35,4cm)	P5029	P6029
Cristallo porta lato 5019 (40,4cm)	P5019	P6019
Cristallo porta lato 5030 (40,4cm)	P5030	P6030
Cristallo porta lato 5020 (45,4cm)	P5020	P6020
Cristallo porta lato 5031 (45,4cm)	P5031	P6031
Cristallo porta lato 5021 (50,4cm)	P5021	P6021
Cristallo porta lato 5022 (60,4cm)	P5022	P6022
Cristallo porta frontale 5001 (52,3cm)	P5001	P6001
Cristallo porta frontale 5002 (52,3cm)	P5002	P6002
Cristallo porta frontale 5003 (57,3cm)	P5003	P6003
Cristallo porta frontale 5004 (57,3cm)	P5004	P6004
Cristallo porta frontale 5005 (62,3cm)	P5005	P6005
Cristallo porta frontale 5006 (62,3cm)	P5006	P6006
Cristallo porta frontale 5007 (67,3cm)	P5007	P6007
Cristallo porta frontale 5008 (67,3cm)	P5008	P6008
Cristallo porta frontale 5009 (72,3cm)	P5009	P6009
Cristallo porta frontale 5010 (72,3cm)	P5010	P6010
Cristallo porta frontale 5011 (77,3cm)	P5011	P6011
Cristallo porta frontale 5012 (77,3cm)	P5012	P6012
Cristallo porta frontale 5013 (82,3cm)	P5013	P6013
Cristallo porta frontale 5014 (77,3cm)	P5014	P6014
	P5015	P6015
	P5016	P6016
Porta 5015/16/17/23/24B 165/200 TRASPARENTE (82,3cm)	P5017	P6017
	P5023	P6023
	P5024	P6024

DETTAGLIO P/ARTICOLI serie TWENTY

Fisso + Porta	Art.
Cristallo fisso + Porta lato da 65-70	2030
Cristallo fisso + Porta lato da 70-75	2031
Cristallo fisso + Porta lato da 75-80	2032
Cristallo fisso + Porta lato da 80-85	2033
Cristallo fisso + Porta lato da 85-90	2034
Cristallo fisso + Porta lato da 90-95	2035
Cristallo fisso + Porta lato da 95-100	2036
Cristallo fisso + Porta lato da 115-120	2037
Cristallo fisso + Porta frontale da 110-115	1999
Cristallo fisso + Porta frontale da 115-120	2000
Cristallo fisso + Porta frontale da 120-125	2001
Cristallo fisso + Porta frontale da 125-130	2002
Cristallo fisso + Porta frontale da 130-135	2003
Cristallo fisso + Porta frontale da 135-140	2004
Cristallo fisso + Porta frontale da 140-145	2005
Cristallo fisso + Porta frontale da 145-150	2006
Cristallo fisso + Porta frontale da 150-155	2007
Cristallo fisso + Porta frontale da 155-160	2008
Cristallo fisso + Porta frontale da 160-165	2009
Cristallo fisso + Porta frontale da 165-170	2010
Cristallo fisso + Porta frontale da 170-175	2011
Cristallo fisso + Porta frontale da 175-180	2012

FISSI (vetro singolo)	Art.
Cristallo fisso lato 70 TWENTY (28,3cm)	F2030
Cristallo fisso lato 75 TWENTY (30,8cm)	F2031
Cristallo fisso lato 80 TWENTY (33,3cm)	F2032
Cristallo fisso lato 85 TWENTY (35,8cm)	F2033
Cristallo fisso lato 90 TWENTY (38,3cm)	F2034
Cristallo fisso lato 95 TWENTY (40,8cm)	F2035
Cristallo fisso lato 100 TWENTY (43,3cm)	F2036
Cristallo fisso lato 120 TWENTY (53,3cm)	F2037
Cristallo fisso 115 TWENTY (51,8cm)	F1999
Cristallo fisso 120 TWENTY (54,3cm)	F2000
Cristallo fisso 125 TWENTY (56,8cm)	F2001
Cristallo fisso 130 TWENTY (59,3cm)	F2002
Cristallo fisso 135 TWENTY (61,8cm)	F2003
Cristallo fisso 140 TWENTY (64,3cm)	F2004
Cristallo fisso 145 TWENTY (66,8cm)	F2005
Cristallo fisso 150 TWENTY (69,3cm)	F2006
Cristallo fisso 155 TWENTY (71,8cm)	F2007
Cristallo fisso 160 TWENTY (74,3cm)	F2008
Cristallo fisso 165 TWENTY (76,8cm)	F2009
Cristallo fisso 170 TWENTY (79,3cm)	F2010
Cristallo fisso 175 TWENTY (81,8cm)	F2011
Cristallo fisso 180 TWENTY (84,3cm)	F2012

PORTE FRONTALI (vetro singolo)	Art.
Cristallo porta 115 TWENTY (58,8cm)	P1999
Cristallo porta 120 TWENTY (61,3cm)	P2000
Cristallo porta 125 TWENTY (63,8cm)	P2001
Cristallo porta 130 TWENTY (66,3cm)	P2002
Cristallo porta 135 TWENTY (68,8cm)	P2003
Cristallo porta 140 TWENTY (71,3cm)	P2004
Cristallo porta 145 TWENTY (73,8cm)	P2005
Cristallo porta 150 TWENTY (76,3cm)	P2006
Cristallo porta 155 TWENTY (78,8cm)	P2007
Cristallo porta 160 TWENTY (81,3cm)	P2008
Cristallo porta 165 TWENTY (83,8cm)	P2009
Cristallo porta 170 TWENTY (86,3cm)	P2010
Cristallo porta 175 TWENTY (88,8cm)	P2011
Cristallo porta 180 TWENTY (91,3cm)	P2012

PORTE LATI (vetro singolo)	Art.
Cristallo porta lato 70 TWENTY (36,3cm)	P2030
Cristallo porta lato 75 TWENTY (38,8cm)	P2031
Cristallo porta lato 80 TWENTY (41,3cm)	P2032
Cristallo porta lato 85 TWENTY (43,8cm)	P2033
Cristallo porta lato 90 TWENTY (46,3cm)	P2034
Cristallo porta lato 95 TWENTY (48,8cm)	P2035
Cristallo porta lato 100 TWENTY (51,3cm)	P2036
Cristallo porta lato 120 TWENTY (61,3cm)	P2037

TWENTY PROFILI E ACCESSORI

	TWENTY CROMO	TWENTY NERO	TWENTY RAME
	Art.	Art.	Art.
KIT angolare 120X90	2038	2039	2062
KIT 1F+1S fino 150	2021	2023	2060
KIT 1F+1S fino 180	2022	2024	2061
KIT 2F+2S fino 190	2042	2043	2063

Modelli in vinile polimerico

TEMPO DI CONSEGNA 2
SETTIMANE

TRAZOS



FROST PLUS



FROST



DESERT



METEOR



BAMBÚ



Stampa digitale in vinile

TEMPO DI CONSEGNA 3
SETTIMANE

PERSONALIZZA IL TUO BOX DOCCIA

Grazie alle possibilità che offrono le tecniche moderne di stampa digitale, possiamo ora personalizzare i nostri box doccia. Con questo tipo di stampa, diamo al cristallo un'immagine unica, grazie alla incorporazione della fotografia, disegni, marchi, lettere, simboli e molto altro. Il nostro sistema di stampa digitale, incorpora una pellicola per la protezione e conservazione dell'immagine del vinile.

Se l'immagine è una foto scattata, è richiesta una qualità minima di 5 Mpx e il formato JPG.

Se l'immagine viene creata o è un file immagine, è richiesta una risoluzione minima di 300 dpi, formato JPG/EPS/PDF, colore CMYK e una dimensione superiore al 70% della dimensione finale di stampa (1Mpx/m2). Sono accettabili anche i file vettoriali.



FRONTALE

ANGOLARE



Sagoma cristalli decorati vinile

- A trazos E desert
 B frost plus F meteor
 C frost G bambú

Cliente
Modello
Descrizione
Art.

Formato

F: FISSO

P: PORTA

FRONTALI

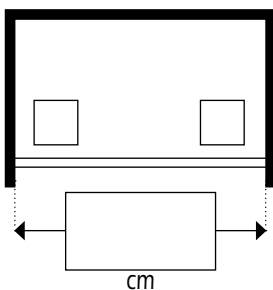

APERTURA ANGOLARE SINISTRA

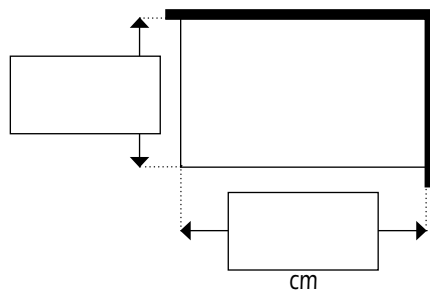

APERTURA ANGOLARE DESTRA

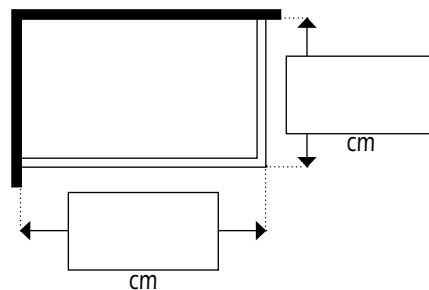

FRONTALE LATERALE FISSO

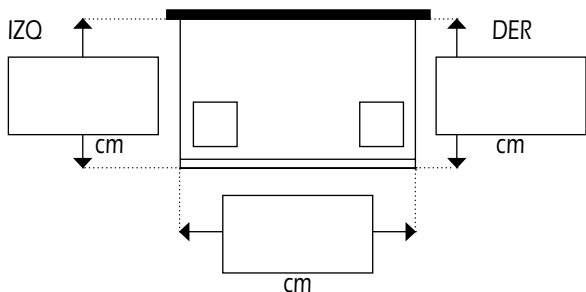

SEMICIRCOLARE

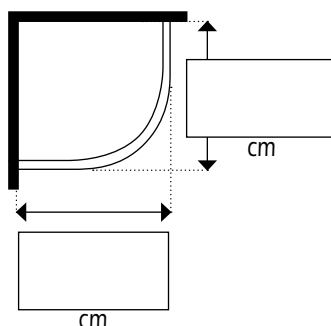

ESEMPIO FRONTALE

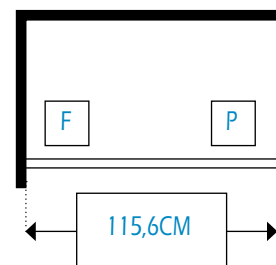

Altezza decorato (max. 118cm)

art.

APPLICATI IN GME FROST / FROST PLUS ACIDE

FRONTALE	OFROST1
ANGOLARE	OFROST2

APPLICATI IN GME RESTO DEI VINILE

FRONTALE	0021
ANGOLARE	0020

APPLICAZIONE IN GME DEI VINILE CON IMPRESSIONE

FRONTALE	0019
ANGOLARE	0018

SOLO VINILE, APPLICAZIONE A CURA DEL CLIENTE

FRONTALE	0023
ANGOLARE	0022



GME PRESENTA LA SUA COLLEZIONE DI PIATTI DOCCIA

Ardesia / Style Plus:

Piatti doccia extrapianti realizzati in resina con una nuova formula di carica minerale e gel coat sanitario di ultima generazione che ci permette di produrre un piatto con una notevole riduzione di peso e una maggiore resistenza alla torsione, mantenendo tutti i vantaggi dei piatti in resina. Questi modelli sono realizzati con una finitura ardesiata e hanno un certificato anticivolo di classe 3, oltre a uno strato di Gel Coat altamente resistente che previene eventuali graffi e la comparsa di organismi come funghi o muffe.



CERTIFICATI

Preoccupati della qualità che offre ai nostri clienti, GME DIVISIÓN BAÑOS SL dispone di certificati che garantiscono la qualità di tutti i suoi prodotti, conformi a tutte le normative europee.

Allo stesso tempo, GME DIVISIÓN BAÑOS SL è associata all'AIDIMME (Istituto Tecnologico), in cui si effettuano ispezioni e test di laboratorio per garantire la qualità e il corretto funzionamento dei prodotti che offre.

Ardesia Plus

Carica minerale di ultima generazione, finitura ardesia
Gel Coat Sanitario ISO NPG

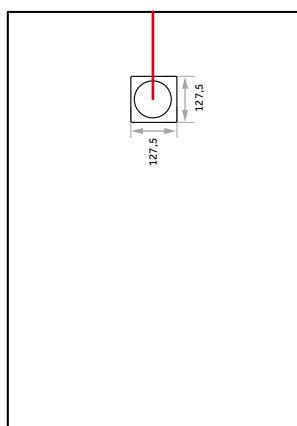

	LARGHEZZA 70	LARGHEZZA 75	LARGHEZZA 80	LARGHEZZA 90	LARGHEZZA 100
90/100	30	30	30	30	30
110	40	35	40	35	35
120	35	35	35	35	35
130	40	40	40	40	40
140	45	40	45	40	40
150	40	45	40	40	40
160	45	50	45	45	45
170	45	50	50	50	45
180	50	50	50	50	50
190	50	52	57	60	50
200	50	52	57	50	50

80x80 / 90x90 / 100x100 e i piatti più lunghi di 200 hanno lo scarico al centro



	BIANCO	GRAFITE	BEIGE	GRIGIO
90x70	3886	3887	3888	3889
100x70	3900	3918	3936	3954
110x70	3901	3919	3937	3955
120x70	3902	3920	3938	3956
130x70	3903	3921	3939	3957
140x70	3904	3922	3940	3958
150x70	3905	3923	3941	3959
160x70	3906	3924	3942	3960
170x70	3907	3925	3943	3961
180x70	3908	3926	3944	3962
190x70	3972	3974	3976	3978
200x70	3973	3975	3977	3979
90x75	7500	7512	7524	7536
100x75	7501	7513	7525	7537
110x75	7502	7514	7526	7538
120x75	7503	7515	7527	7539
130x75	7504	7516	7528	7540
140x75	7505	7517	7529	7541
150x75	7506	7518	7530	7542
160x75	7507	7519	7531	7543
170x75	7508	7520	7532	7544
180x75	7509	7521	7533	7545
190x75	7510	7522	7534	7546
200x75	7511	7523	7535	7547
80x80	3830	3832	3834	3836
100x80	3909	3927	3945	3963
110x80	3910	3928	3946	3964
120x80	3911	3929	3947	3965
130x80	3912	3930	3948	3966
140x80	3913	3931	3949	3967
150x80	3914	3932	3950	3968
160x80	3915	3933	3951	3969
170x80	3916	3934	3952	3970
180x80	3917	3935	3953	3971
190x80	3980	3982	3984	3986
200x80	3981	3983	3985	3987

	BIANCO	GRAFITE	BEIGE	GRIGIO
90x90	3831	3833	3835	3837
100x90	3840C	3849C	3858C	3867C
120x90	3840	3849	3858	3867
130x90	3841	3850	3859	3868
140x90	3842	3851	3860	3869
150x90	3843	3852	3861	3870
160x90	3844	3853	3862	3871
170x90	3845	3854	3863	3872
180x90	3846	3855	3864	3873
190x90	3847	3856	3865	3874
200x90	3848	3857	3866	3875
100x100	3700	3712	3724	3736
110x100	3701	3713	3725	3737
120x100	3702	3714	3726	3738
130x100	3703	3715	3727	3739
140x100	3704	3716	3728	3740
150x100	3705	3717	3729	3741
160x100	3706	3718	3730	3742
170x100	3707	3719	3731	3743
180x100	3708	3720	3732	3744
190x100	3709	3721	3733	3745
200x100	3710	3722	3734	3746
220x100	3711	3723	3735	3747

ARDESIA XXL

Art.

Lungo fino 160 Larghezza 120 cm	3990
Lungo fino 220 Larghezza 70 a 90 cm	3998
Lungo fino 220 Larghezza 120 cm	3991

Tempo di consegna 3 settimane
Scarico centrale in XXL con lunghezza da 100 a 120 cm o lunghezza da 200 a 220 cm.

*Include una piletta tecnica extra-piatta con fissaggio a vite + coperchio di scarico a scomparsa

PIATTI SU MISURA E TAGLIO

(è richiesto un disegno tecnico)

- Tagli con **finitura Gel Coat art. 7777**

*Tempo di consegna 2 settimane

- Tagli **senza finitura Gel Coat art. 8888 / gratuito**

*Tempo di consegna 2 settimane

*Opzione consigliata solo quando la parte tagliata si occulta contro la parete



GRIGLIE COLORATE PAGINA SEGUENTE

ARDESIA PLUS GRIGLIE COLORATE



GRIGLIA NERA
art. 0382NG



GRIGLIA BIANCA
art. 0382BL



GRIGLIA BEIGE
art. 0382BE



GRIGLIA GRIGIO
art. 0382GR

ARDESIA PLUS GRIGLIE COLORATE



GRIGLIA ORO
art. 0382OR



GRIGLIA RAME
art. 0382CB



GRIGLIA NICHEL
art. 0382NK



GRIGLIA TITANIO
art. 0382T

Ardesia Plus Semicircolare

Carica minerale di ultima generazione, finitura ardesia
Gel Coat Sanitario ISO NPG



Qualsiasi altro colore della tabella RAL
Fornito con griglia in acciaio inox

***Tempo di consegna 3 settimane**

(Non si accettano cancellazioni una volta effettuato l'ordine)

A	B	C	R	Kg
800	800	320	550	18
900	900	370	550	19

Técnico

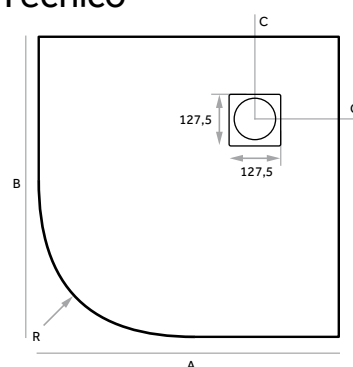



GRIGLIA BIANCA
art. 0382BL



GRIGLIA NERA
art. 0382NG



GRIGLIA BEIGE
art. 0382BE



GRIGLIA GRIGIO
art. 0382GR



GRIGLIA ORO
art. 0382OR



GRIGLIA RAME
art. 0382CB



GRIGLIA NICHEL
art. 0382NK



GRIGLIA TITANIO
art. 0382T

RAGGIO SEMICIRCOLARE STANDARD R 55

	BIANCO	GRAFITE	BEIGE	GRIGIO
80x80	3820	3822	3824	3826
90x90	3821	3823	3825	3827

*Include una piletta tecnica extra-piatta con fissaggio a vite + coperchio di scarico a scomparsa

PIATTI SU MISURA E TAGLIO

(è richiesto un disegno tecnico)

Piatti su misura prezzo in base alla misura immediatamente superiore es. 175x76 P.V.P. = 180X80 + taglio **7777/8888**

- Tagli con finitura **Gel Coat** art. **7777**

*Tempo di consegna 2 settimane

- Tagli senza finitura **Gel Coat** art. **8888 / gratuito**

*Tempo di consegna 2 settimane

*Opzione consigliata solo quando la parte tagliata si occulta contro la parete

Style Plus

Carica minerale di ultima generazione, finitura ardesia
Gel Coat Sanitario ISO NPG

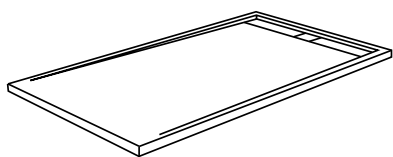

Distanza dalla valvola

Larghezza 70/80 cm **12 cm**

Larghezza 90 cm **14 cm**



Qualsiasi altro colore della tabella RAL
Fornita con griglia in acciaio inox

Tempo di consegna 3 settimane

(Non si accettano cancellazioni una volta effettuato l'ordine)



	BIANCO	GRAFITE	BEIGE	GRIGIO
90x70	4886	4887	4888	4889
100x70	4900	4918	4936	4954
110x70	4901	4919	4937	4955
120x70	4902	4920	4938	4956
130x70	4903	4921	4939	4957
140x70	4904	4922	4940	4958
150x70	4905	4923	4941	4959
160x70	4906	4924	4942	4960
170x70	4907	4925	4943	4961
180x70	4908	4926	4944	4962
190x70	4972	4974	4976	4978
200x70	4973	4975	4977	4979
<hr/>				
100x80	4909	4927	4945	4963
110x80	4910	4928	4946	4964
120x80	4911	4929	4947	4965
130x80	4912	4930	4948	4966
140x80	4913	4931	4949	4967
150x80	4914	4932	4950	4968
160x80	4915	4933	4951	4969
170x80	4916	4934	4952	4970
180x80	4917	4935	4953	4971
190x80	4980	4982	4984	4986
200x80	4981	4983	4985	4987
<hr/>				
120x90	4840	4849	4858	4867
130x90	4841	4850	4859	4868
140x90	4842	4851	4860	4870
150x90	4843	4852	4861	4871
160x90	4844	4853	4862	4872
170x90	4845	4854	4863	4873
180x90	4846	4855	4864	4874
190x90	4847	4856	4865	4875
200x90	4848	4857	4866	4876

*Include una piletta tecnica extra-piatta con fissaggio a vite + coperchio di scarico a scomparsa

PIATTI SU MISURA E TAGLI

Piatti su misura prezzo in base alla misura immediatamente superiore es. 175x76 P.V.P. = 180X80 + taglio **7777/8888**

OPZIONI DI TAGLIO

art. **7777** / Tagli con finitura Gel Coat

*Tempo di consegna 2 settimane

art. **8888** / Tagli senza finitura Gel Coat / **gratuito**

*Tempo di consegna 2 settimane

*Opzione consigliata solo quando la parte tagliata si occulta contro la parete.



CERTIFICATO DI CLASSE 3

Massima qualificazione
ANTISCIVOLO

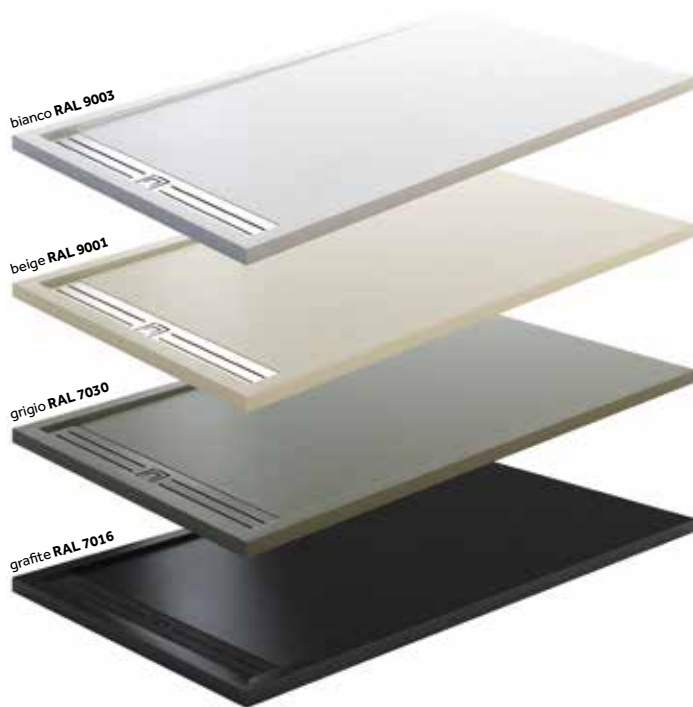

Griglia Style color

Misura/colore	INOX COLORE	RESINA
Griglia 70 Bianca	0383BL70	0380BL70
Griglia 80 Bianca	0383BL80	0380BL80
Griglia 90 Bianca	0383BL90	0380BL90
Griglia 70 Beige	0383BE70	0380BE70
Griglia 80 Beige	0383BE80	0380BE80
Griglia 90 Beige	0383BE90	0380BE90
Griglia 70 Grigia	0383GR70	0380GR70
Griglia 80 Grigia	0383GR80	0380GR80
Griglia 90 Grigia	0383GR90	0380GR90
Griglia 70 Grafite	0383NG70	0380NG70
Griglia 80 Grafite	0383NG80	0380NG80
Griglia 90 Grafite	0383NG90	0380NG90



GRIGLIA COLORE



GRIGLIA RESINA

NUOVI PIATTI RIQUADRATI ARDESIA PLUS

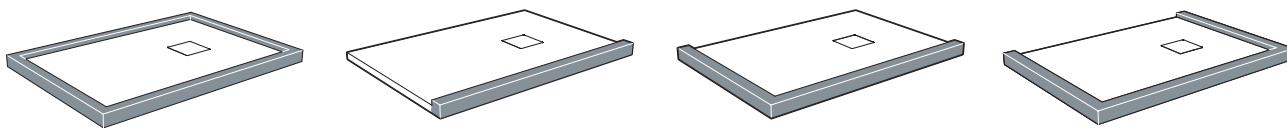

Descrizione	Art.
Riquadro a metro lineare 4x4 cm std	0970

È obbligatorio ricevere un disegno tecnico.

Per calcolare il prezzo di un piatto riquadrato, aggiungere al prezzo del articolo std, il costo dei metri lineari di riquadro.

La parte riquadrata del piatto, misurerà 4x4 cm se non diversamente richiesto.

Tempo di consegna 2 settimane.

RICAMBI PIATTI DOCCIA

GRIGLIE



Griglia Inox Ardesia



Griglia Inox Style 70

Griglia Inox Style 80

Griglia Inox Style 90

RICAMBI PILETTA SCARICO



Piletta standard art. 0372



Sifone



Cestino



Tappo sifone



Set di gomma

KIT DI RIPARAZIONE



Kit di pittura

Kit di pittura + stucco

Kit di pittura piatto completo

PANNELLI VASCA



PANNELLI ARDESIA PLUS +RIGIDO +RESISTENTE

Pannelli in vetroresina e Gel Coat di 0,6 cm di spessore

Finitura [STYLE/ARDESIA](#)

	Altezza fino 55	Altezza 55 a 110
Lungo	Art.	Art.
Fino a 70 cm	1411	1415
Da 71 cm a 100 cm	1412	1416
Da 101 cm a 140 cm	1413	1417
Da 141 cm a 208 cm	1414	1418

Tempo di consegna 3 settimane

BATTISCOPIA

Battiscopa fino 9 cm di altezza

Battiscopa fino 9 cm a 15 cm di altezza

*Indicare Modello/Misura/Colore

Tempo di consegna 2 settimane

ESPOSITORI BOX DOCCIA

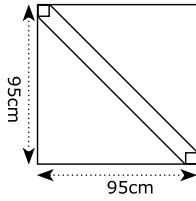

art. GME01
2 Box doccia da **90x90**

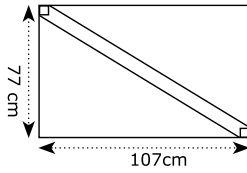

art. GME02
2 Box doccia da **100x70**

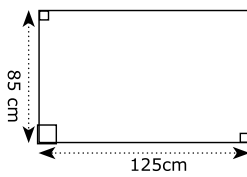

art. GME04
3 Box doccia
Box doccia **120x80**
open/akord **70**
Frontale **110**

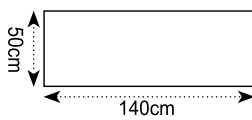

art. GME07
3 Box doccia
Frontale **140**



art. GME11
Espositore con pilastri di 2 mt
in alluminio laccato bianco

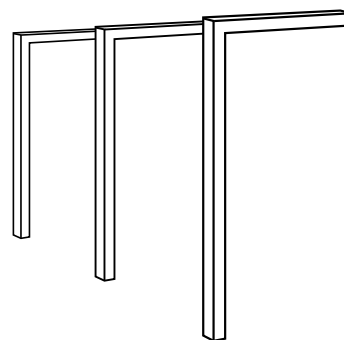

EXPOSITORE PIATTI



art. GME06
2 piatti doccia **120x70**
120x80



ESPOSITORI RUBINETTERIA IO



art. GME03
4 colonne doccia

art. GME03+GME12
4 serie di miscelatori
2 colonne doccia/1 miscelatore+incasso



art. GME10
Misura 161x43x50 cm
6 miscelatori IO
1 Colonna doccia



art. GME17
Misura 135x60x27 cm
3 miscelatori IO
2 Colonna doccia



art. GME13
Misura 80x40 cm
9 miscelatori IO



art. GME14
Misura 120x61 cm
14 miscelatori IO



art. GME12
2 miscelatori IO



art. GME16
Misura 30x30 cm
1 miscelatore+incasso



art. GME15
Misura 11x8 cm
1 miscelatori IO

IOΦ[®] by GME

IO® è il marchio europeo della rubinetteria progettata e prodotta da **GME División Baños S.L.** Con oltre 30 anni di esperienza nella commercializzazione e distribuzione di prodotti orientati al condizionamento integrale del bagno.

Il gruppo sviluppa due linee di business generali, una delle quali agisce come delegazione di produttori di primo livello, mentre l'altra produce e commercializza prodotti con il marchio **GME**.

Rubinetteria IO di GME dispone di tutte le linee di rubinetteria necessarie per il bagno e la cucina, con un'ampia varietà di formati e 7 colori che seguono le ultime tendenze del mercato.

Finiture con trattamento PVD in colori metallici con lo stesso tono della nostra varietà di cabine doccia colorate.

CATALOGO
RUBINETTERIA IO



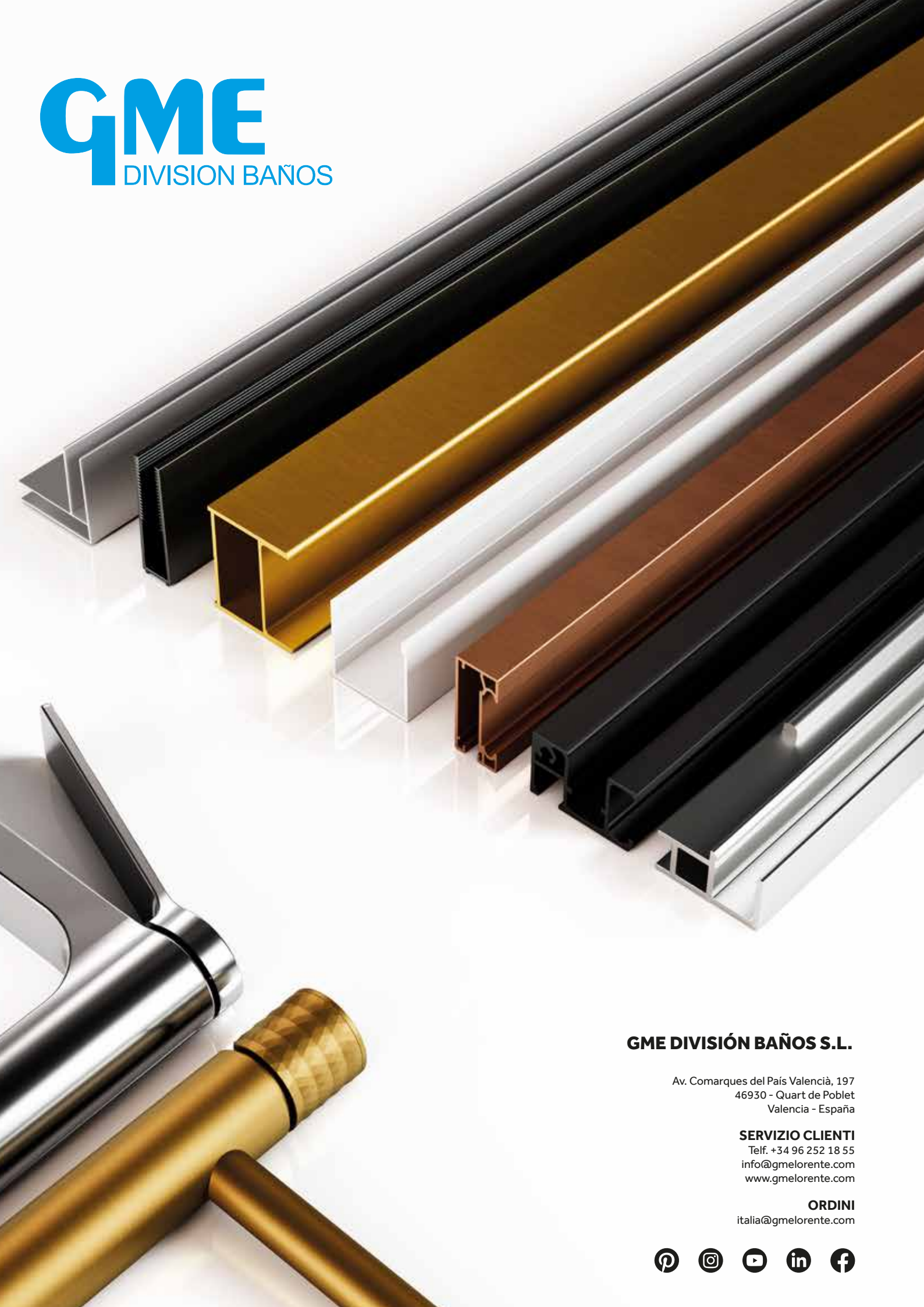

GME DIVISIÓN BAÑOS S.L.

Av. Comarques del País Valencià, 197
46930 - Quart de Poblet
Valencia - España

SERVIZIO CLIENTI

Telf. +34 96 252 18 55
info@gmelorente.com
www.gmelorente.com

ORDINI

italia@gmelorente.com

